

QST

DEVOTED ENTIRELY TO

AMATEUR RADIO

Published by the American Radio Relay League

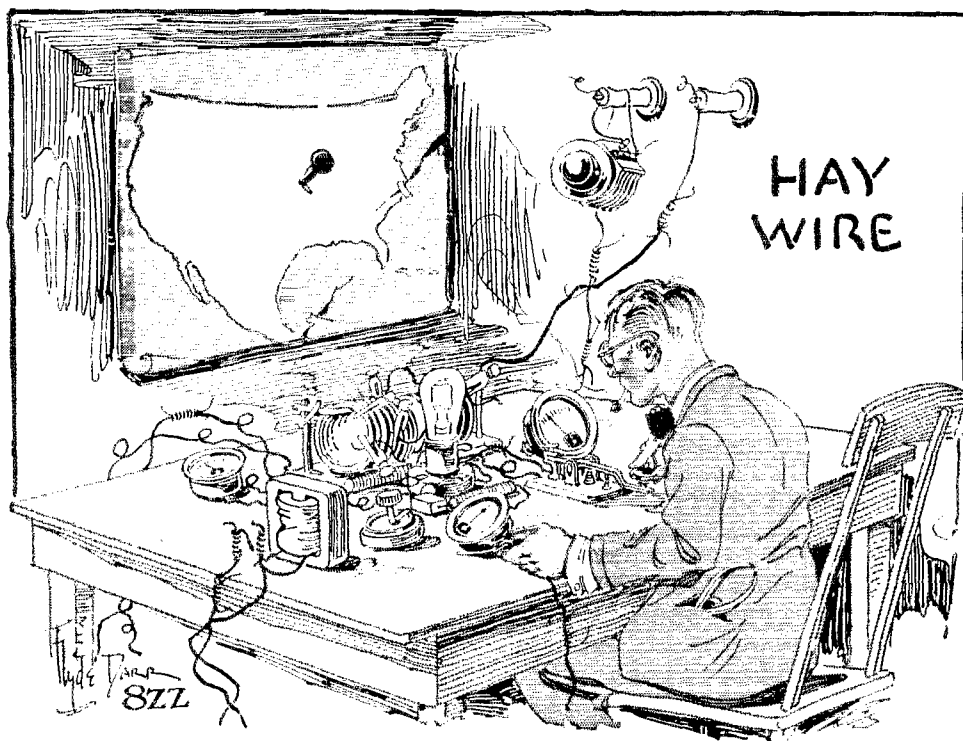

FEBRUARY
1927

25¢

Cunningham

RADIO TUBES

Since 1915—
Standard for all Sets

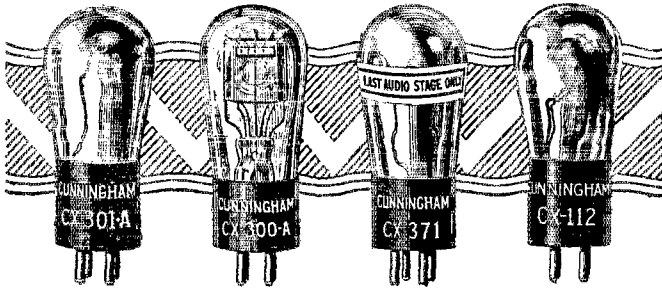

The Tubes That Fill Millions of Sockets

Every radio receiver requires one tube as a detector, one tube to feed adequate undistorted power to the loud speaker and may have one to six or more stages of intermediate radio or preliminary audio frequency amplification. If your receiver is designed for 5-volt tubes, the right combination includes a special detector, **CX-300A**, a power output tube, **CX-371** or **CX-112**, and **CX-301A** in all other sockets.

Consult your radio dealer. He will tell you the right combination of Cunningham Radio Tubes for your receiver.

CX-300A, CX-371, CX-112 CX-301A and eleven other types in the orange and blue carton

E. T. CUNNINGHAM, Inc.

NEW YORK

CHICAGO

SAN FRANCISCO

SEEING
M O R E
THAN THE
MICROSCOPE

Electrons, which are very important in radio, are too small for any microscope to make visible. Yet our eyes can watch their paths—study their habits.

In the laboratories where Radiotrons are studied there are instruments which make all these things possible—and more. Knowing how many electrons leap across from the filament to the plate of a vacuum tube is in its way as abstruse a study as the measurement of distant stars by astronomers. Yet this abstruse research has a definite application in the RCA Radiotron in your radio set. That is why the laboratories back of RCA spend millions in scientific research that is far too much like "pure science" for an ordinary manufacturer.

Radiotrons are improved and new ones are developed, to make radio better. Because this research shows in results, Radiotron users keep five great factories busy!

Watch your tubes, always, for the RCA mark. You will find it on Radiotrons for every purpose.



clear up the tone

Do you get a blast when you turn the volume up a bit? Do you get sweet, clear tone at low volume, but noise when it's louder? The trouble's probably right in one tube—the tube in the last audio stage. The Radiotron laboratories discovered that no ordinary tube can let big volume through clearly. Change one tube to an RCA power Radiotron. Then turn up the volume . . . and it comes through clear.

Bring your storage battery set up-to-date with
a power RADIOTRON UX-171 or UX-112
a detector RADIOTRON UX-200-A
and RADIOTRONS UX-201-A for all-round quality.

Bring your dry battery set up-to-date with
a power RADIOTRON UX-120
and RADIOTRONS UX-199 for all-round quality.

RADIO CORPORATION OF AMERICA - NEW YORK - CHICAGO - SAN FRANCISCO

RCA Radiotron

MADE BY THE MAKERS OF THE RADIOLA

AMERTRAN RADIO PRODUCTS

Sold only at
Authorized AmerTran
Dealers

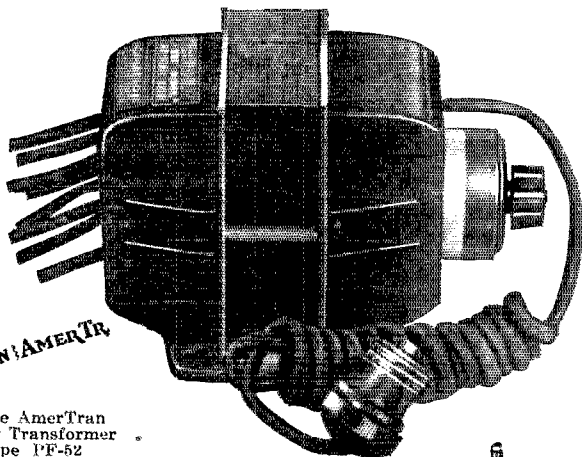

The AmerTran
Power Transformer
Type PF-52
\$18.00 Each

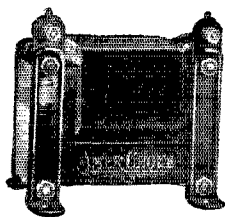

The AmerChoke
Type 854
\$6.00 Each

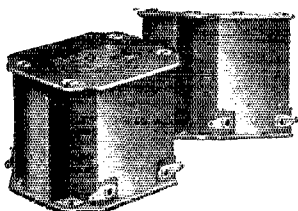

The AmerTran
De Luxe
Audio Transformer
Made for 1st and 2nd
stages
\$10.00 Each

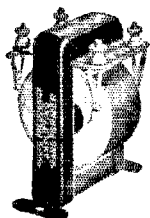

AmerTran Audio Trans-
formers AF-7 and AF-6
for two stages, \$5.00 Each

By recommending AmerTran Radio Products for the purposes to which they are best suited, we believe that the experimenter and engineer will more quickly appreciate the high standards of these products in design, construction and performance.

The AmerTran Power transformer is thoroughly dependable used as an ordinary half-wave Rectifier (400 v 60 ma. D. C.) in conjunction with the AmerChoke type 854 as a filter choke. And the same transformer is adapted to an 800 v 60 ma. D. C. double half-wave Rectifier using two rectifier tubes and the AmerChoke.

Transformers of larger rating and higher voltages have been built for various radio concerns by this company since the beginning of the industry. Experimenters and engineers are invited to come to us for information on any special apparatus or on the use of standard AmerTran parts.

Send now for free booklet "Improving the Audio Amplifier" and other interesting technical data.

American Transformer Company

178 Emmet Street

Newark, N. J.

"Transformer Builders for Over 26 Years"

Section Communications Managers of THE COMMUNICATIONS DEPARTMENT, A. R. R. L.

			ATLANTIC DIVISION		
Eastern Pennsylvania	8BQ		H. M. Walleze	307 No. James St.	Hazleton
Maryland-Delaware-District of Columbia	3AB		A. B. Goodall	1824 Ingleside Terrace	Washington, D. C.
Southern New Jersey	3EH		H. W. Densham	140 Washington St.	Collingswood
Western New York	8PI		G. S. Taylor	508 Masten St.	Buffalo
Western Pennsylvania	8XB		C. L. Crossley		State College
			CENTRAL DIVISION		
Illinois	9AAW		W. B. Schweitzer	4264 Hazel Ave.	Chicago
Indiana	9C9Q		D. J. Angus	310 N. Illinois St.	Indianapolis
Kentucky	9ARU		D. A. Downard	116 No. Longworth Ave.	Louisville
Michigan	8ZZ		G. E. Darr	137 Hill Ave.	Highland Park, Detroit
Ohio	8BYN		H. C. Storek	694 Carpenter St.	Columbus
Wisconsin	9VD		C. N. Crapo	443 Newton Ave.	Milwaukee
			DAKOTA DIVISION		
North Dakota	9EEN		G. R. Moir	618 11th Street, South	Fargo
South Dakota	94DW		P. J. Beck		Millbank
North Minnesota	90GU		C. L. Barker		Henning
South Minnesota	98YA		D. B. Cottam	3538 Thrd Ave. So.	Minneapolis
			DELTA DIVISION		
Arkansas	5AIP		Leonard Clippard	2408 North Pierce St.	Little Rock
Louisiana	5UK		C. A. Feitag	129 Camp St.	New Orleans
Mississippi	5AKP		J. W. Gullett	1708 23rd Ave.	Meridian
Tennessee	4KM		L. K. Rush	4 Second St.	Bemis
			HUDSON DIVISION		
Eastern New York	2ADH		Earle Peacox	Box 113	Yonkers
N. Y. C. & Long Island	2CWR		P. H. Marston	117-11 140th St., So.	Ozone Park, L. I.
North New Jersey	2WB		A. G. Wester, Jr.	50 Princeton St.	Hillton
			MIDWEST DIVISION		
Iowa	9BKV		A. W. Kruse		Akron
Kansas	9DNG		P. S. McKeever	University Heights	Lawrence
Missouri	9RR		L. B. Litzure	8010 Mercier St.	Kansas City
Nebraska	9BYG		C. B. Deihl	5605 Cedar St.	Omaha
			NEW ENGLAND DIVISION		
Connecticut	1RM		H. E. Nichols	82 Elmwood Ave.	Bridgeport
Maine	1B1G		Frederick Best	13 E. Crescent St.	Augusta
Eastern Massachusetts	1BVL		R. S. Briggs	233 Ashmont St.	Dorchester
Western Massachusetts	1D4		A. H. Carr	30 Nassau St.	Worcester
New Hampshire	1AET		V. W. Hodge	227 Main St.	Waremont
Rhode Island	1BVB		D. B. Fancher	22 Summer St.	Westerly
Vermont	1AJG		C. T. Kerr		Pouliny
			NORTHWESTERN DIVISION		
Alaska*	7FD		L. H. Machin	Box 452	Cordova
Idaho	7ST		Henry Fletcher	1107 State St.	Boise
Montana*	7NT		A. H. Willson		Ramsey
Oregon*	7TF		A. C. Dixon, Jr.	1350 East 36th St.	Portland
Washington*	7FD		Otto Johnson	1340 30th St. W.	Seattle
			PACIFIC DIVISION		
Hawaii*			John A. Lucas	Box 1142, Fort Shafter	Oahu
Nevada	6TO		C. B. Newcombe		Yerington
Los Angeles	6BUR		L. E. Smith	340 No. Painter Ave.	Whittier
Santa Clara Valley	6NX		P. J. Quement	51 Pleasant St.	San Jose
East Bay	6ZW		P. W. Dann	262 35th St.	Oakland
San Francisco*	6BX		G. W. Lewis	748 14th St.	San Francisco
Sacramento Valley*	6CBS		C. F. Mason	2530 N. St.	Sacramento
Arizona	6ANS		D. E. Lamb	229 W. First St.	Mesa
Philippines (provisional)	60LAU		Manuel I. Felzardo	252 Galicia St.	Manila, P. I.
			ROANOKE DIVISION		
North Carolina	1JR		R. S. Morris	413 Broad St.	Gastonia
Virginia	3CA		J. F. Wohlford	118 Cambridge Ave.	Roanoke
West Virginia	8BSU		C. S. Hofman	426 Chantal Court	Wheeling
			ROCKY MOUNTAIN DIVISION		
Colorado	9CAA		C. R. Stedman	1641 Albion St.	Denver
Utah-Wyoming	6RM		Don C. McItas	214 Belvedere Apts.	Salt Lake City
			SOUTHEASTERN DIVISION		
Alabama	5AJP		A. D. Trum	217 Catoma St.	Montgomery
Florida	4QY		W. F. Grogan	Box 816	St. Myers
Georgia-South Carolina-Cuba-Porto Rico-Isle of Pine	4KU		H. L. Reid	11 Shadowlawn Ave.	Atlanta
			WEST GULF DIVISION		
Northern Texas	5AJT		W. B. Forrest, Jr.	502 Royal St.	Waxaharrie
New Mexico*			F. M. Ebrat	2904 N. Robinson St.	Oklahoma City
Oklahoma	5APG		E. A. Sahn	146 N. Academy St.	New Braunfels
Southern Texas	5YK				
			MARITIME DIVISION		
Newfoundland	8AR		Loyal Reid	Avalon House	St. Johns
New Brunswick	1ET		T. B. Lacey	C. N. B. Power Co.	St. John
Nova Scotia	1DD		W. C. Borrett	14 Sinclair St.	Dartmouth
Prince Edward Island	1BZ		W. A. Hyndman	25 Fitzroy St.	Charlottetown, P. E. I.
			ONTARIO DIVISION		
Ontario	9BJ		W. Y. Sloan	167 Close Ave.	Toronto
			QUEBEC DIVISION		
Quebec	2BE		Alex Reid	202 Birch Ave.	St. Lambert
			VANALTA DIVISION		
Alberta	4GT		A. H. Asmusseiz	2133 18th St. W.	Calgary
British Columbia	5BJ		E. S. Brooks	c/o Forestry Dept. Radio Court House, Vancouver	Vancouver
			PRAIRIE DIVISION		
Manitoba*	4DD		F. E. Rutland, Jr.	452 St. John Ave.	Winnipeg
Saskatchewan	4BU		W. J. Pickering	514 19th St. W.	Prince Albert

*Temporary officials appointed to act until the membership of the SCMs by the nomination and election.

Section concerned choose permanent

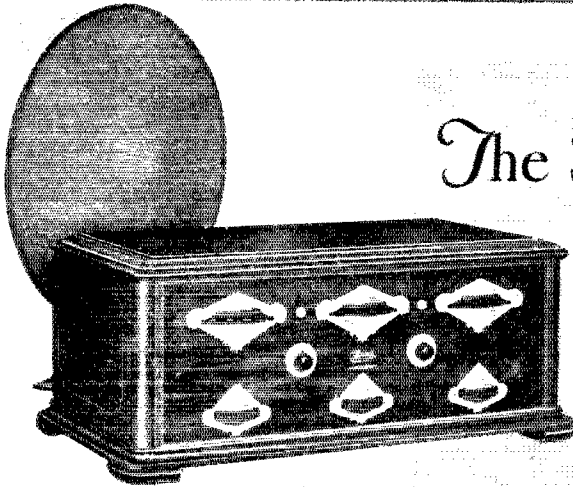

The Synchronphase~ One Dial for Convenience Three for Precision

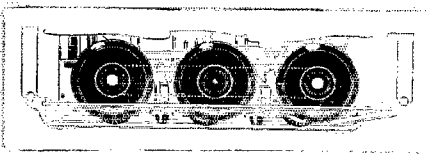

Grebe Flexible Unit Control

makes the Synchronphase a set of one, two or three dial control at your option.

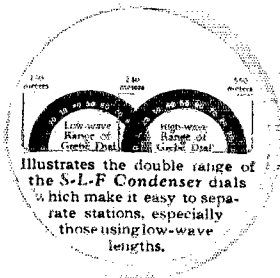

THE simplicity of one-dial control, so much exploited today, was given the Synchronphase in 1925 when the *Flexible Unit Control* was installed.

But the convenience of one-dial operation was *not* made at the sacrifice of individual dial setting—a great advantage when extremely accurate tuning is desired.

A review of radio development shows that Grebe is usually well in advance; viz., *Bino-cular Coils, S-L-F Condensers, Colortone, Low-Wave Extension Circuits, etc.*

Send for Booklet Q which fully explains all exclusive Grebe developments and how they produce the reception for which Grebe sets are noted.

A. H. Grebe & Co., Inc., 109 W. 57th St., New York
Factory: Richmond Hill, N. Y.
Western Branch: 443 So. San Pedro St., Los Angeles, Cal.

This Company broadcasts through stations WAHG and WBOQ

All Grebe apparatus is covered by patent granted and pending.



THE GREBE SYNCHROPHASE

TRADE MARK REG. U.S. PAT. OFF.



QST



The Official Organ of the A.R.R.L.

VOLUME XI

FEBRUARY, 1927

NUMBER 2

Editorials	7
Financial Statement	8
How Our Tube Circuits Work <i>No. 2 The Colpitts Circuit</i> <i>Robert S. Kruse</i>	9
A Small Neutralizing Condenser	15
A Neat Wavemeter	15
Radio Frequency Transformer Design in Voltage-Stabilized Systems <i>Fred J. Marco</i>	16
Developments in Tuned Inverse Duplex <i>No. 2</i> <i>David Grimes</i>	21
Standard Frequency Schedules	27
Rotten Reasons <i>The Old Man</i>	28
Multi-Contact Control Switches	30
A D.C.-A.C. Crystal-Controlled Transmitter	31
A Compact Receiver <i>Alpha Learned</i>	34
A new Radio Circuit <i>Robert H. Marriott</i>	36
The Antenna on the July Cover	38
On Top of the World <i>nc5GO</i> <i>R. M. Foster</i>	39
Measuring Capacity with a Voltmeter <i>Willard H. Farr</i>	40
An Airplane Transmitter <i>G. H. Browning and R. S. Briggs</i>	41
Experimenters' Section Report	43
Amateur Radio Stations <i>BIG</i>	45
I.A.R.U. News	47
Calls Heard	51
Correspondence	55

QST is published monthly by The American Radio Relay League, Inc., at Hartford, Conn., U. S. A. Official Organ of the A.R.R.L. and the International Amateur Radio Union

Kenneth B. Warner (Secretary, A.R.R.L.),
Editor-in-Chief and Business Manager

F. Cheyney Beekley,
Managing Editor and Advertising Manager

Robert S. Kruse,
Technical Editor

Harold P. Westman,
Assistant Technical Editor

David H. Houghton,
Circulation Manager

Subscription rate in United States and Possessions, Canada, and all countries in the American Postal Union, \$2.50 per year, postpaid. Single copies, 25 cents. Foreign countries not in American Postal Union, \$3.00 per year, postpaid. Remittances should be by international postal or express money order or bank draft negotiable in the U. S. and for an equivalent amount in U. S. funds. Entered as second-class matter May 29, 1919, at the post office at Hartford, Connecticut, under the act of March 3, 1879. Acceptance for mailing at special rate of postage provided for in section 1103, Act of October 3, 1917, authorized September 8, 1922. Additional entry as second-class matter, acceptable at special rate of postage provided for above, at Springfield, Mass., authorized September 17, 1924.

Copyright 1927 by the American Radio Relay League, Inc.. Title registered at United States Patent Office.
Member of the Radio Magazine Publishers' Association.

THE AMERICAN RADIO RELAY LEAGUE

The American Radio Relay League, Inc., is a non-commercial association of radio amateurs, bonded for the promotion of interest in amateur radio communication and experimentation, for the relaying of messages by radio, for the advancement of the radio art and of the public welfare, for the representation of the radio amateur in legislative matters, and for the maintenance of fraternalism and a high standard of conduct.

It is an incorporated association without capital stock, chartered under the laws of Connecticut. Its affairs are governed by a Board of Directors, elected every two years by the general membership. The officers are elected or appointed by the Directors. The League is non-commercial and no one commercially engaged in the manufacture, sale or rental of radio apparatus is eligible to membership on its Board.

"Of, by and for the amateur", it numbers within its ranks practically every worth-while amateur in the world and has a history of glorious achievement as the standard-bearer in amateur affairs.

Inquiries regarding membership are solicited. A bona fide interest in amateur radio is the only essential qualification; ownership of a transmitting station and knowledge of the code are not prerequisites. Correspondence should be addressed to the Secretary.

OFFICERS

President
HIRAM PERCY MAXIM
Hartford, Conn.

Vice-President
CHAS. H. STEWART
St. Davids, Pa.

Communications Manager
F. E. HANDY
Hartford, Conn.

Treasurer
A. A. HEBERT
Hartford, Conn.

Secretary
K. B. WARNER
Hartford, Conn.

DIRECTORS

President
HIRAM PERCY MAXIM
Drawer 2102
Hartford, Conn.

Vice-President
CHAS. H. STEWART
St. Davids, Pa.

Canadian General Manager
A. H. E. RUSSELL
5 Mail Bldg.
Toronto, Ont.

Atlantic Division
Dr. EUGENE C. WOODRUFF
234 W. Fairmount Ave.
State College, Pa.

Central Division
CLYDE E. DARR
137 Hill Ave., Highland Park.
Detroit, Mich.

Dakota Division
C. M. JANSKY, JR.
Dept. of Elec. Eng., U. of M.
Minneapolis, Minn.

Delta Division
BENJ. F. PAINTER
424 Hamilton Nat'l Bank Bldg.
Chattanooga, Tenn.

Hudson Division
DR. LAWRENCE J. DUNN
480 East 19th St.,
Brooklyn, N. Y.

Midwest Division
PORTER H. QUINBY
Box 134A, Route 6,
Omaha, Neb.

New England Division
DR. ELLIOTT A. WHITE
Dartmouth College
Hanover, N. H.

Northwestern Division
K. W. WEINGARTEN
3219 No. 24th St.,
Tacoma, Wash.

Pacific Division
ALLEN H. BABCOCK
65 Market St.,
San Francisco

Roanoke Division
W. TREADWAY GRAVELY
503 Main St.,
Danville, Va.

Rocky Mountain Division
PAUL M. SEGAL
c/o District Attorney
West Side Court Bldg.,
Denver, Colo.

Southeastern Division
HARRY F. DOBBS
c/o Dobbs & Wey Co.,
Atlanta, Ga.

West Gulf Division
FRANK M. CORLETT
2515 Catherine St.,
Dallas, Tex.

Address General Correspondence to Executive Headquarters, Hartford, Conn.

EDITORIALS

WITH deep regret *QST* announces the resignation of Mr. John M. Clayton, 1DQ, its assistant technical editor, who has removed to New York City to become the assistant secretary of the Institute of Radio Engineers. One of the Ancients in American amateur radio, Mr. Clayton started with pre-war 5BV-5ZL at Little Rock and was in succession O.R.S., A.D.M., Division Manager, a director of the League, and, at Headquarters, in charge of the Information Service desk, editor of the "Current Radio" syndicate, and *QST*'s assistant technical editor. He has certainly left his mark on the ol' mag, his intensely practical constructional articles in particular having created for him a most enviable reputation in amateur radio. This sounds a lot like an obituary, and indeed that is about the way we feel. He is not lost to amateur radio, tho, and in fact probably will have more leisure to pound amateur brass than he did at Hq. It is needless to say that our best wishes go with him. Incidentally, we'll now expect to see a "Calls Heard" department in the *I.R.E. Proceedings*. Hi!

Mr. Harold P. Westman, 1AL, for the past year in charge of the A.R.R.L. Information Service, becomes the new assistant technical editor. Having a long and varied amateur experience, particularly in the field of construction, he is well equipped for his new duties.

And now for an announcement somewhat extraordinary. Mr. Ross A. Hull, ex-0a3JU, and honorary federal secretary of the Wireless Institute of Australia, is in this country to study American radio methods, particularly American amateur radio. To get a better close-range picture of the American ham in action, Mr. Hull has temporarily associated himself with A.R.R.L. Headquarters and is now in charge of our Information Service.

We can wax warmly enthusiastic over this idea, even tho it is near zero outside to-day. We used to go to the west coast and south for Headquarters men, so that we might have a staff truly national in its viewpoint. Now we find ourselves with a man from the Antipodes, fitting testimony to the international growth of amateur radio. This is good for us; we get fresh viewpoints on every subject, many new ideas. We hope it will prove equally beneficial to the Australian amateurs to have their secretary acquainted with the inside picture of the American amateur—the ideas he acquires

here are bound to draw us closer. One can day-dream over this thought a bit and visualize the amateur societies of the world in the not too distant future exchanging their officers like the universities exchange professors to-day, acquiring invaluable experience with new problems, exchanging ideas with mutual benefit, and ripening into wider appreciation of the possibilities of our international relations. Oh for that endowment!

EVER wonder what the Government thinks of us amateurs? The following is quoted from the annual report of the Chief Signal Officer of the Army:

"For many years the Signal Corps has taken keen interest in the amateur radio operators of the country, who have many times aroused the admiration of the nation by their contribution to radio development and research, by the tremendous distances they have frequently bridged with their low-powered inexpensive home-built sets, and by the devotion they have displayed in transmitting important information when normal channels of communication have been destroyed. Thru the hearty cooperation of the American Radio Relay League and the unceasing efforts of the army corps area commanders and their signal officers, close and cordial affiliations with the amateur operators have been established. As a result there has been opened up a new and vast network of radio channels of communication which will be of great potential value in time of emergency. And there has been made available to the Signal Corps a large reservoir of radio operators who will have received most valuable training in time of peace and who can be more quickly adapted to military needs in time of emergency. The establishment of such close contact with the radio amateur is a step toward better preparedness."

And from the annual report of the Commissioner of Navigation, Department of Commerce, the following:

"On June 30th there were 14,902 active amateur radio stations in the United States. . . . Amateurs in this country are taking advantage of all improvements made in the art and are inclined to more readily adopt new ideas than is possible with the larger stations where much experimenting must be done before changes are made which involve large expenditures of time and money. Practically all amateurs are now using con-

tinuous-wave transmitters, many of them having crystal control. With the amateurs, the spark set is considered obsolete as is the crystal receiving set."

Aren't these testimonials bully, fellows? We must carry on, that we may continue to be held in this high regard.

AND still no radio legislation! Not that we care so very much, as amateurs, but plenty of other people want it. At this writing the Congressional conference committee seems to be in a beautiful deadlock. Some of the politicians complain of the "tremendous amount of propaganda which is being adroitly disseminated in favor of the House radio bill." Surest thing you know! We may be all wet but we can't get over the recollection that for years and years the problem has been to get the various radio interests reconciled to a single radio administrative idea, and now that they all agree the politicians won't give it to them, for reasons of their own. We think we are safe in saying that there is now agreement in the art. The National Coordinating Committee, representing about all branches of the art, including our A.R.R.L., has reported in favor of the form of administration provided in the House (White) bill, that is, administration under the Department of Commerce. Propaganda adroitly disseminated? We think not—it seems to us to be the long-awaited agreement within the art. Then why not legislation? We can only suspect that radio has now become so important a factor in American life that politicians opposed to Mr. Hoover do not want to see him receive the tremendous credit which will accrue to his department from a successful administration. In the past we had no legislation because no one could determine what the art really wanted; are we now to be denied it from considerations of political expediency?

AS an emergency measure in radio administration, the President signed Congressional Joint Resolution 125 on December 8th, which thereupon became law, by the terms of which it is now necessary for all applicants for a station license, whether new or renewal, to submit with their application a "wavelength waiver". By this document the applicant "waives any right or any claim of right, as against the United States, to any wavelength, or to the use of the ether in radio transmission, because of previous license to use the same or because of the use thereof."

Altho aimed primarily at the broadcasters, this resolution unfortunately applies also to coastal and ship stations, amateurs, experimental stations—every kind of station. Its purpose supposedly is to prevent a broadcaster from investing a million dollars and then claiming that he has a "vested interest" in a wavelength whether the Gov-

ernment is willing or no. We do not see that it has any particular effect upon us amateurs. We don't see that our refusal to sign it would guarantee us any rights that we otherwise would lose. It is also to be noted that it is now the law of the United States that it must be signed to get a license. We don't think that we amateurs have a claim, *as against the United States*, to the use of the ether, for we admit that we operate under regulations that the government creates to grant us privileges. Our right to operating territory in the frequency spectrum is a moral one, based upon the fact that our existence is justified by the results we produce and by our value to the country, and these are things that no one can take away from us. The signing of the waiver does not invalidate our claim, as against other radio interests, to adequate wave-bands if the government permits any operation whatever in the waves we are interested in. We therefore see no objection to the execution of the waiver by amateurs applying for new or renewal station licenses.

K. B. W.

Financial Statement

BY order of the Board of Directors the following statement of the income and disbursements of the American Radio Relay League for the third quarter of 1926 is published for the information of the membership.

K. B. WARNER, Secretary.

STATEMENT OF REVENUE AND EXPENSES FOR THE THREE MONTHS ENDED SEPT. 30, 1926.

REVENUE			
Advertising sales	\$20,249.76		
Newsdealer sales	11,598.38		
Newspaper syndicate sales	500.32		
Dues and subscriptions	7,955.29		
Back numbers, etc.	45.86		
Emblems	167.00		
Interest earned	167.71		
Cash discounts earned	384.96	\$41,069.28	
Deduct:			
Returns and allowances	4,231.10		
Provision for reserve for newsdealer returns	59.54		
Discount 2% for cash	282.53		
Exchange and collection charges	13.27	4,586.44	
Net Revenue			36,482.84
EXPENSES			
Publication expenses	\$12,372.53		
Salaries	11,654.35		
Newspaper syndicate expenses	367.55		
Forwarding expenses	455.81		
Telegraph, telephone and postage	1,697.24		
Office supplies and general expense	1,366.47		
Rent, light and heat	827.80		
Traveling expenses	485.92		
Depreciation of furniture and equipment	211.43		
Bad debts written off	529.47		
Communications Dept. field expenses	101.95		
Total Expenses		\$30,630.57	
Net Gain from Operations			\$ 5,852.27

How Our Tube Circuits Work

No. 3, The Colpitts Circuit

By Robert S. Kruse, Technical Editor

WHEN one starts to explain the Colpitts circuit it is necessary to start on an entirely fresh trail or else start over the same trail and branch off sharply.

Let us do the second of these.

Referring back again to Figure 1 you will recall that we began with the "plain audion" of 1A, converted it into the "tickler feedback" scheme of 1B, then into the receiving circuit of 1C and finally into the transmitting circuit of 1D. Taking another start we (in Figure 7) developed the tickler feedback circuit of 7A into the Armstrong tuned-plate tuned-grid circuit of 7C.

This performance of Figure 7 is important in considering the Colpitts circuit, for it pointed out that we could have feedback and oscillation without any magnetic coupling between coils; one can get the necessary feedback *through the tube itself*.

CAPACITY FEEDBACK

That is the important thing—we can operate with magnetic feedback thru a pair of coils or one can operate with electric feedback thru the tube capacity. Usually we call the magnetic feedback systems (Hartley, tickler, Meissner) by the sloppy and inexact name of "inductive" feedback systems. The Armstrong and Colpitts systems are quite correctly known as capacity-feedback systems. Personally I prefer to say "magnetic feedback" and "electric feedback".

The main thing to be learned from Figure 7 was just the one point, that we can operate with electric feedback thru the tube capacity. Let us remember that and forget the rest of Figure 7 entirely in what follows. In various places there has already been shown the "fundamental Hartley" circuit which here appears as Fig. 9A. Study this diagram carefully. You will notice that it has a tuned circuit which consists of L_1 , L_2 and C_1 , all in series. The grid is tied to one end of this tuned circuit, the plate is tied to the other and the filament is connected to a center-tap (roughly) on the coil. That is very important and is the rule under which all of our oscillating circuits work—at any instant the grid voltage is opposite to the plate voltage and the filament is *somewhere in between*. If the thing isn't put together that way it will not oscillate. If it is put together that way the chance of oscillation is very good.

Now let us look for a moment at Fig. 9B. This is the tuned circuit of the Hartley ar-

rangement with the tube taken off. It is two coils in series with a condenser, a tap being taken off between the two coils. (You can look at it as a single-tapped coil if you care to).

Now look at Fig. 9C. Here we have two condensers in series with a coil. It is the same thing as 9B except that the coils and

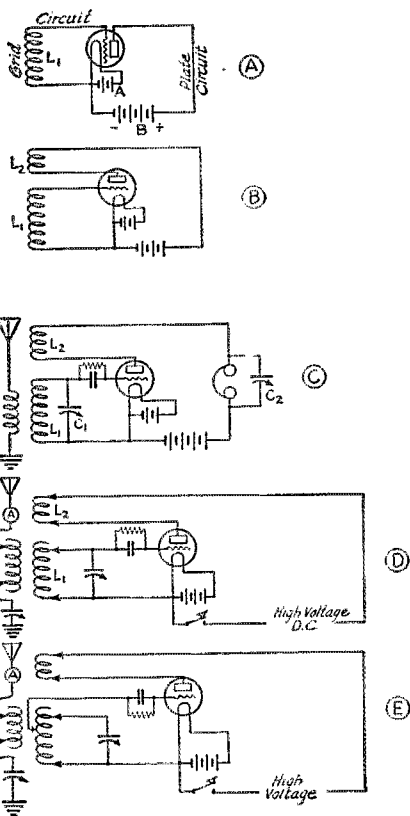

FIG. 1

condensers have been swapped around. In 9B we center-tapped the coil, in 9C we have center-tapped the condenser. In both cases the point 2 is at a voltage which is somewhere between 1 and 3. Talking about both coils at once we can say that at a moment when the r.f. voltage at 1 is plus then it will be minus at 3 and nearly zero at 2.

THE COLPITTS CIRCUIT

Good! We have that perfectly clearly in mind and can proceed to make up an oscilla-

tor using the circuit of 9C instead of the one of 9B. This we have done in Fig. 10, where the two circuits are shown side by side in various stages of development. At A we again have the fundamental circuits, at B the tubes have been connected but one can see at once that the circuits will not work because the Hartley circuit has the plate supply shorted and the Colpitts arrangement has the plate circuit open. We can make the Hartley circuit work as a series or shunt feed arrangement but the

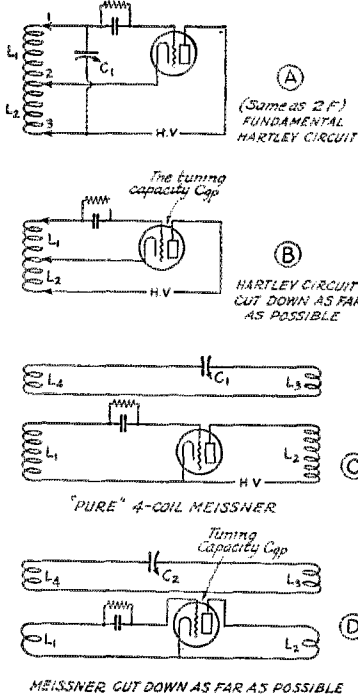

FIG 5 HOW THE HARTLEY AND MEISSNER CIRCUITS GO WRONG

usual Colpitts arrangement is a shunt-fed one and we will make them both shunt-fed for the sake of comparison. In Fig. 9C both circuits are shown in their simplest workable form. Notice, that in both we have the grid-leak connected from the grid directly to the filament with a small choke in series to keep r.f. losses down as much as possible. In the Colpitts circuit this arrangement is strictly necessary. A leak connected across C_1 in the usual way would not have any useful effect since there still would be a gap in the path of the grid current—the gap caused by C_2 . In the Hartley arrangement we could of course put the leak across C_1 and omit the grid choke if we pleased. In both circuits we have had to add C_1 to act as a

grid condenser and C_2 to act as a plate-blocking condenser, that is to say a condenser which blocks the plate supply and prevents it from getting into the rest of the system. If this condenser were omitted from the Hartley arrangement we would have the plate supply short-circuited thru

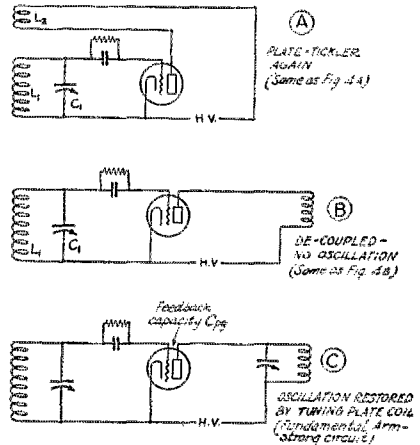

FIG. 7 DEVELOPING THE ARMSTRONG CIRCUIT FROM THE PLATE TICKLER

L_1 . In the Colpitts arrangement the only bad effect would be to put the plate supply on the stators of C_1 and C_2 , also on L_1 , thereby making the set "hot" to the touch and requiring that both C_1 and C_2 stand the plate voltage in addition to the r.f. voltage. It is generally better to use C_2 except at very short waves—of which you will hear more later.

MODIFIED COLPITTS CIRCUITS

Looking back at the other circuits we have talked about one will notice that their differences are mainly in ease of control and adjustment. The final output from any of them is about the same—in spite of all the violent personal opinions on that point. So too, the Colpitts circuit is different from the others mainly in the way in which it controls.

For instance—suppose that we wish to change (slightly) the wavelength of the Colpitts and Hartley circuits of Fig. 10C. For the Hartley circuit we have only to move the condenser C_1 and the thing is done. It is not that simple for the Colpitts circuit. If we move C_1 we do change the wavelength—but we also upset the grid feedback and must readjust C_2 . C_2 in turn changes the wavelength a little and we must re-set C_1 to get the right wavelength again. This is what we call an "interlocking" adjustment and is likely to be a great nuisance. There are several ways of getting around it—and we will take the most complicated ones first

because they are the ones that have been used the longest. Looking at Fig. 10D we see that two changes have been made; a 4th clip has been added and the condenser C_4 has been made variable. By moving the extra clip one is able to adjust the grid feedback in much the same free way as in the Hartley circuit—and the clip is not necessarily “outside” of clip 3 though I have happened to show it that way. The movement of this clip does not have a very great tuning effect,

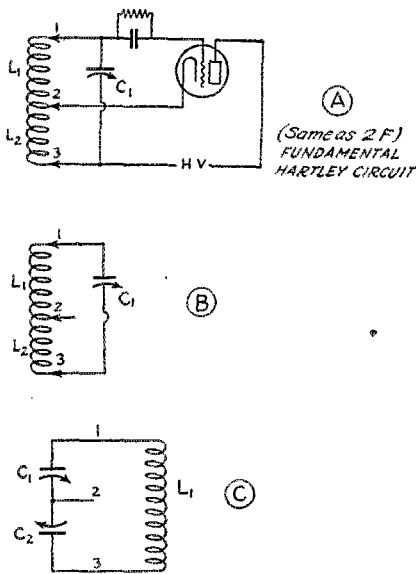

FIG 9A-HARTLEY & COLPITS

at least no more than in the case of the Hartley circuit.

The variable grid condenser can be understood easily enough, the smaller the capacity there the more nearly the grid is cut loose and hence the less feedback.

Now we can make some general rules. Increasing C_1 raises the wavelength and also raises the grid feedback. Increasing C_2 raises the wavelength but cuts down the grid feedback. By working C_1 and C_2 together we can evidently run the wave up and down without much effect on the feedback, therefore the tube will keep on working evenly. If we don't wish to do that we can change C_1 and C_2 and make up for the effect by adjusting C_4 or clip 4. We do not need to use both clip 4 and C_4 . The clip will be better at short waves where one cannot stand a lot of additional “junk” in the set, otherwise C_4 is probably handier.

THE HOFFMAN ARRANGEMENT

It isn't my intention to blame a particular circuit arrangement on one man unless I am sure that he is guilty. The “balanced” form of the Colpitts circuit will here be

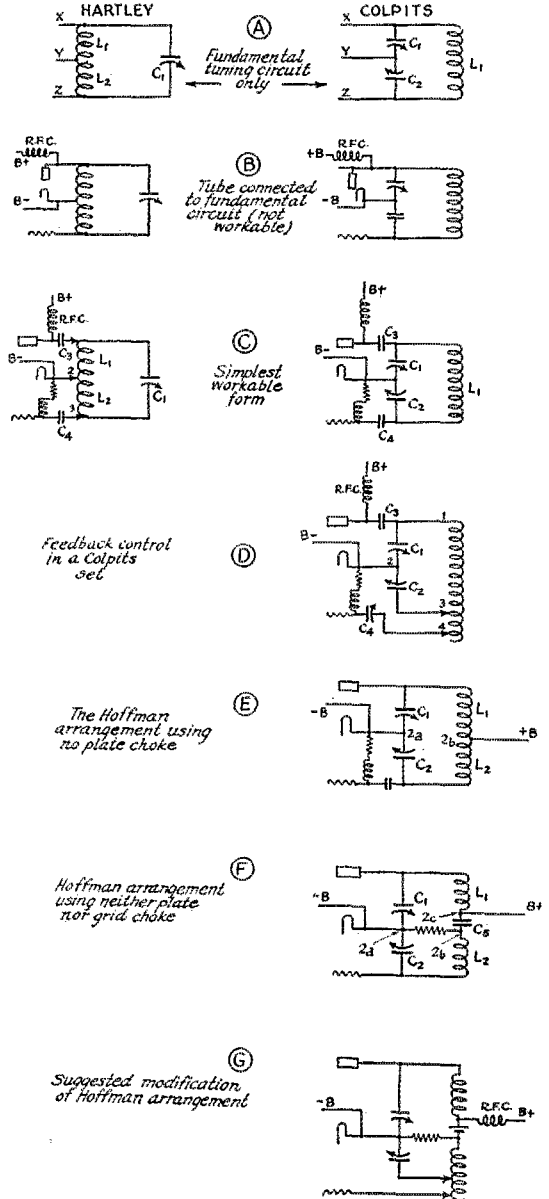

FIG. 10 COLPITS CIRCUITS

called by the name of W. H. Hoffman of the Burgess Laboratories purely because there should be some handy way of referring to it, and most of us have heard of it in con-

nection with 9EK-9XH where Hoffman has used it at all manner of wavelengths, including 5 meters and below.

Reduced to its simplest form the "Hoffman arrangement" is shown in Fig. 10E. It will be seen that the difference between this and 10D is that the plate-blocking condenser C_1 is missing and that the plate supply is being fed to the middle of the coil L_1-L_2 . This may seem like a senseless proceeding since it puts the high-voltage d.c. on the helix and both variable condensers but

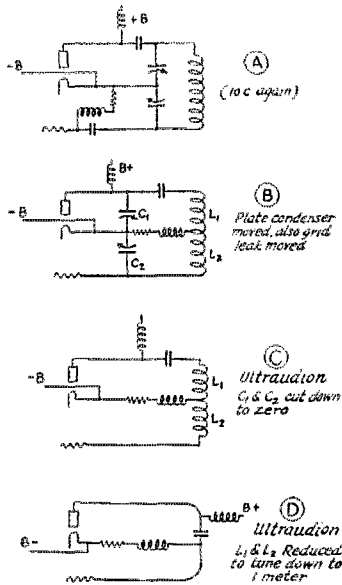

FIG 11 COLPITTS & ULTRAUDION

there is a good reason for the change. Remembering back to the Hartley circuit you will recall that it was always possible to find a "zero voltage point" on the helix. When we went to the Colpitts circuit there was a zero voltage point between the two condensers. Very well, these two points have no r.f. voltage between them. Referring to Fig. 10E this means that there is no r.f. voltage between point 2A and point 2B. There is d.c. voltage—but no r.f.

There does not seem to be much point to this "discovery" until one remembers what a thunder of a time we have with our r.f. chokes; we never are satisfied that the things are any good—and usually we are right. Does it not, then seem worth while to try a circuit in which there is no need for an r.f. choke in the plate circuit?

ADJUSTING THE BALANCED ARRANGEMENT

Naturally if one wants to use a balanced arrangement one must be sure that the

thing is really balanced. If C_1 and C_2 have the same capacity then L_1 and L_2 will be about equal, but if C_2 is larger the arrangement will be in balance again when the B-plus tap is moved down so as to make L_2 smaller. You read that correctly— L_2 must be made smaller when C_2 is made larger. An easy way to make the first adjustment is to put an R.F. choke in the B-plus lead and to try hunting for r.f. voltages between 2A and 2B by means of a short wire with a good mica condenser cut into it—any capacity but good enough to stand the plate voltage plus. If you get fireworks between the two points anyone can see that we do not have the same voltage at 2A and 2B, therefore the clip at 2B must be reset. Don't worry too much about this adjustment—even if you are off a bit you can leave the r.f.c. in the plus lead and call the adjustment good enough; the choke will certainly have less work to do than if it went directly to the plate in the usual way.

NO CHOKES AT ALL

The grid choke is still with us—and it too can be gotten rid of. In Fig. 10F we have broken the helix by means of a very large capacity C_1 . It need not run up a microfarad but simply be 10 times the capacity of the tuning condensers. This condenser will not have much effect on the arrangement of r.f. voltages in the circuit, hence we can stick to the previous assurance that the r.f. plate choke will not be able to create much trouble. C_1 does however give us two points 2B and 2C which are at almost the same r.f. voltage but insulated at d.c. We can then connect the grid-leak return to 2B and the B plus to 2C without upsetting anything at all and will not need an r.f. grid choke since 2A and 2B do not have any r.f. voltage between them.

The only remaining thing is to tie C_1 and C_2 together mechanically, whereupon we have a very simple arrangement that will work down to short waves nicely and be rather easy to adjust at all waves, except as to tube efficiency. About the only control on that is by changing the grid-leak. Personally I would like this circuit better with the grid tied to a separate clip as in 10G—though I will admit that this partly does away with one of the main advantages of the Colpitts circuit—the removal of the double-tuning effect at short waves.

EXTREME SHORT-WAVE OPERATION

This double-tuning effect is the biggest nuisance of short-wave work. When we used a Hartley circuit and cut it down to short waves we wound up with a circuit that operated on the tube capacity only—and it is a poor enough arrangement as is amply testified by the horrible noises made by the average U. S. 20-meter station. When one

tries to steady the thing up by using a condenser the helix must be cut down still further and there results two tuned circuits—one thru the tube and one thru the condenser—which are nearly enough alike so that the tube jumps back and forth, making an almost unreadable mess and creating a good deal more "audio fading" than ever really happened in the ether.

The same effect was observed in the Meissner circuit of Fig. 5 which is here reproduced for a quick review.

The Armstrong circuit behaved better as regards double tuning and the Colpitts circuit provides the easiest way out of the whole difficulty. Unless I am greatly mistaken it is very much the steadiest of our circuits at 5 meters with 50-watt tubes, and even at 20 meters it should show an advantage with these tubes which get down with the least ease of any that I know of. These situations seem likely to be improved soon—but that is in the future.

CUTTING DOWN THE COLPITTS CIRCUIT

Suppose now that we start to cut down a Colpitts circuit and see what happens. In Fig. 11A we again have the familiar (I hope) "Simplest workable Colpitts circuit". In 1B we have moved the plate-blocking condenser with no particular effect except to put plate voltage on the stator of C_1 , which isn't important as long as one does not touch the stator. The grid-leak has also been transferred to the center of the helix after the Hoffman fashion. This is still a Colpitts circuit—but wait.

Suppose now that we start to tune down by reducing C_1 and C_2 until we have cut C_1 and C_2 down to nothing—in other words removed them. This gives us 11C, which is the familiar old "Ultraudion", possibly the daddy of all our oscillatory tube circuits—though I refuse to be quoted as having said that such was the case. Whether or not the Ultraudion and the Colpitts circuit are the same thing. I don't care to say, for several very excellent reasons. One of these is that I am not an authority on tube patents and another is that there are several possible ways of reasoning on the thing—and the results of these lines of reasoning are not the same.

THE ULTRAUDION

The important thing for us is that there is such a thing as the Ultraudion, that it works, and that it can be understood by working from the Colpitts circuit as we have just done.

Having the Ultraudion of Fig 11C we can see that the tuned circuit *must* consist of the coil L1-L2 in series with the capacity between the plate and grid. That being the case we can cut down the wavelength by the simple process of reducing L1 and L2. This gives us the circuit of 11D which is our star

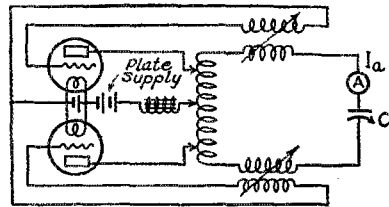

A - BALANCED VALLAURI
PLATE DIRECT COUPLED
GRIDS INDUCTIVELY COUPLED

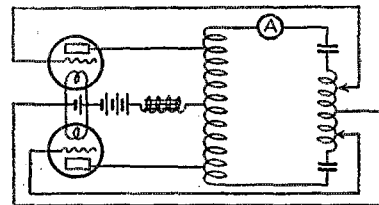

B - BALANCED HARTLEY
PLATE & GRID DIRECT COUPLED

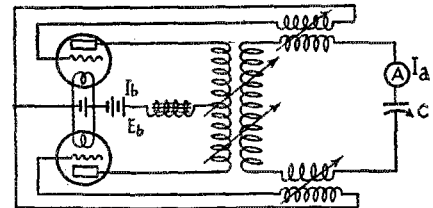

C - BALANCED MEISSNER
PLATES & GRIDS INDUCTIVELY COUPLED

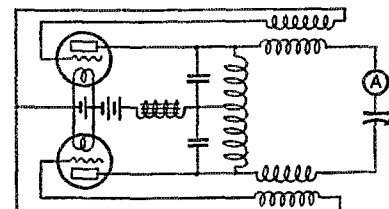

D - BALANCED MODIFIED COLPITTS
PLATE CAPACITY COUPLED
GRID INDUCTIVELY COUPLED

FIG. 12—BALANCED CIRCUITS WITH
PLATE CHOKE

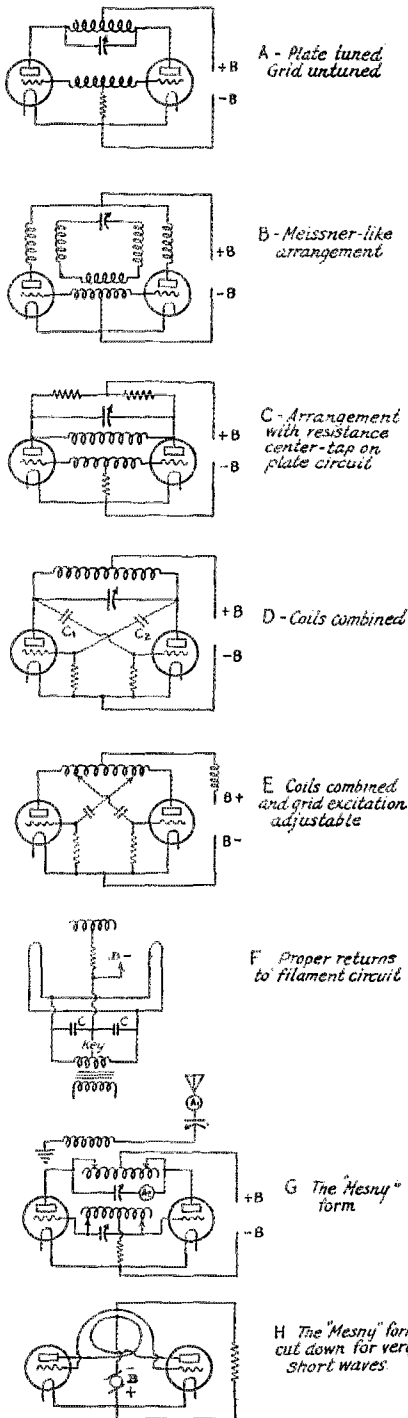

FIG. 13 BALANCED CIRCUITS NOT USING PLATE CHOKER

performer on extreme short waves. I have never had this arrangement fail to work on a frequency of 60,000,000 cycles per second (5-meter wavelength) with any tube that happened to come handy. The DeForest H-tube gets down to 1-meter with this circuit and operates steadily. A 50-wattter does not care about going down that far but will consider 3 meters. I do not know how far down the UX-210 will go, but 3 meters is nothing at all. Note though that the grid leak and the plate feed are connected close to the stopping condenser. The thing will not work decently otherwise for every evident reason. It is also necessary to use r.f. chokes that are of some good.

THE MANY MODIFICATIONS

There is no end to the modifications of these circuits that can be made. In some of them the antenna serves as one of the condensers—and these are "out" for A.R. R.L. by our agreement with the Department of Commerce. Obviously any one of these various circuits can be coupled to the antenna in any one of the half-dozen ways that we are accustomed to, and the antenna can be of any sort desired. These things have little or nothing to do with the sort of primary circuit used.

THE VALLAURI CIRCUITS

One modification does "rate" some attention. This is the "back to back" circuit of Vallauri shown in Fig. 12A which is taken from a Bureau of Standards paper by E. S. Purrington. Note that this arrangement does not operate the tubes "back to back" in the usual amateur fashion where a.c. supply is used and the tubes work alternately. In the Vallauri scheme the intention is to use d.c. supply and to make the tubes work together in a sort of "push-pull" manner.

The same general idea can be applied to our well-known circuits. Examples of this are shown in Figs. 12B, 12C and 12D. Closely related to all of these is the familiar Mesny arrangement of Fig. 13G and 13H which differs in not having the choke in the common plate lead. In the estimation of Mr. Purrington this may materially change the nature of the tube performance and those trying the circuit are advised to try the choke also. The size of the choke is not important—it is there simply to keep the supply current steady and must be large enough for that purpose. If it is not there is a possibility of harmonic currents in the plate supply lead, which may damage the efficiency of the arrangement.

Major Raven-Hart suggests that both Eccles and Jordan have some claim to this general sort of circuit and shows the variations given in Figure 13 A, B, C and D which are shown by Eccles and Jordan in a Radio Review article of 1919. In this connection

Mr. Purrington says that Vallauri in 1917 showed a balanced arrangement with the plate direct-coupled to the load and the grid inductively coupled. This gets things nicely mixed up and we seem at liberty to call our present arrangements Vallauri, Mesny, Eccles or whatever we wish. Having gotten into the habit I shall probably continue to use Vallauri's name without thereby "taking sides".

From Major Raven-Hart's letter are also taken the several variations in the latter part of Fig. 13 which more or less explain themselves. All work along the general scheme of the circuits in the Purrington paper which makes very interesting reading for one interested in tube circuits.

GENERAL

That must close the present discussion. Variations of all sorts can be made, but there is not the sign of a need for explaining all of them. Having gotten a few of them thoroughly "licked" the experimenter has a basis for understanding the rest if he will only use it fully. Whenever there turns up a circuit that "works but shouldn't" the explanation is simple—the circuit is not working as you think it is. Study will show that the affair is acting reasonably. Nature obeys her own laws every time.

A Small Neutralizing Condenser

IT is mighty handy to have a neutralizing condenser that won't take up as much room as the active tuning units. As they need only be adjusted once, the smaller they are the better.

The one in the illustration is of novel design and has a range of from two to fifty micromicrofarads. Adjustment is made by screwing down on the screw passing through the center of the phosphor bronze plate. The plate is so shaped that as it is pressed down

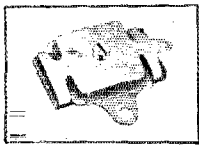

by the adjusting screw it gradually flattens out and is practically flat when it is tight against the lower plate. The lower plate is made of brass and there is a piece of mica stuck to it to prevent short circuiting when the screw is down tight. The base is of bakelite.

It is designed to be mounted directly on the binding posts of the socket or condenser. It may be used to adjust gang condensers so that they run together. The top plate may be reversed so as to have the lug on the opposite side if this is desirable. The device is manufactured by the Hammarlund Manufacturing Company of New York City.

—H. P. W.

A Neat Wavemeter

THE wavemeter which appears below is an exceedingly neat job. It is built into a mahogany cabinet and is supported on an aluminum panel with a hammered finish. The condenser is a Cardwell "taper plate", having a maximum capacity of 250 μfd . The dial is a Marco vernier type

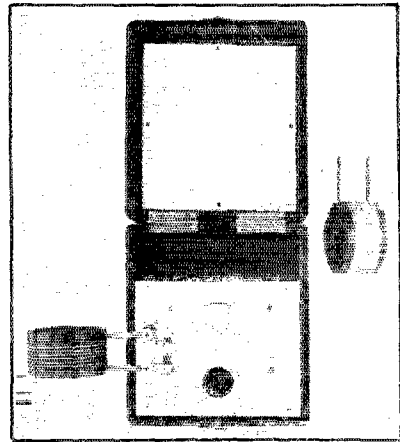

mounted below the panel, the scale showing through a window in the panel. Two coils are ordinarily supplied. They are wound on machine-notched hard rubber tubing with number 18 bare wire, silver plated. The coils are fitted with long silver-plated posts terminating in General Radio plugs which fit the mounting terminals in either a vertical or horizontal manner. The range with the smaller coil (shown in the mounting) is from 18 to 45 meters and the range with the other coil is from 40 to 110 meters. A small Neon gas lamp is shunted across the condenser, being mounted on clips fitted to the two mounting pillars. This lamp has practically no thermal lag or drag. The case of the meter is shielded with brass sheet formed into a box, all joints being thoroughly soldered.

A calibration chart with curves for both coils and a handy reference table giving the wavelength at five points on each coil, are mounted in the lid of the case, under celluloid. The meter can be supplied with coils of other ranges at no additional cost. It is a nice job and is being manufactured by E. B. Duvall of Edmonston, Maryland.

—J. M. C.

Strays

Speaking of our dear old Rettysnitch, one of the stenos in the office recently typed it Jennysnitch. Hi!

Radio Frequency Transformer Design in Voltage-Stabilized Systems

By F. J. Marco*

WE shall concern ourselves in this paper with the design of one type of loss-stabilized, tuned radio frequency amplifier system. In order to present the case clearly it is very helpful to review quickly the general considerations surrounding a tuned r.f. stage.

There are three methods of limiting regeneration in a radio-frequency amplifier, that of bridge-balancing, that of loss-or power-stabilization and, more recently, that of phasing the plate circuit energy so that it cannot react upon the grid circuit.

In order to understand the design of a radio frequency transformer fully it is

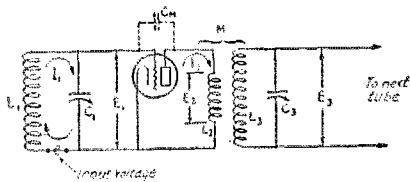

FIG. 1. FUNDAMENTAL CIRCUIT OF ONE TUNED R.F. AMPLIFIER STAGE

necessary that we first analyze the action which takes place in the system with which it is to be used. Referring to Figure 1, we have the fundamental circuit of the one tuned stage of such an amplifier. $L_1 C_1$ constitutes the tuned input to the amplifier tube, L_2 is the transformer primary and L_3 is the secondary, which, when tuned with the condenser C_2 impresses a voltage on the grid-filament circuit of the next tube. It is convenient to look on the voltage impressed on the input of the first stage as a small series voltage, e , which may be either impressed magnetically, thru mutual inductance to the coil L_1 , (from a primary) or in any other convenient manner. The circuit is tuned to resonance with the frequency of this input voltage, e , and when in this condition presents the minimum impedance to the flow of current circulating indicated by the arrows in the LC circuit. Therefore we have a circulating current I , whose value is determined by Ohm's law and is therefore equal to the impressed voltage divided by the resistance of the tuned circuit, or e/R . This current, I , in circulating thru the inductance L_1 , builds up a voltage E_1 across

the LC circuit, which is usually much larger than e . The voltage E_1 is the a.c. grid potential of the tube and controls, in the usual manner, the electron flow of the tube. This control gives rise to an a.c. plate current, I_2 , which is of the same frequency and character as I_1 , but of greater magnitude. The current flows thru the primary of the transformer L_2 , which transfers energy to its secondary circuit $L_3 C_2$, in the same manner giving rise to the voltage E_2 , of the same frequency as E_1 , but of greater magnitude, which is the input voltage to the next tube. The ratio of E_2 to E_1 is called the "voltage gain per stage", and in the usual system is somewhere between 5 and 20, although very poor systems may give less than 5 and extremely efficient laboratory receivers may give more than 20. (The writer has worked with stages giving as high as 65 non-regenerative voltage gain.)

It should be understood that the above analysis and sample figures refer to the non-regenerative gain per stage, which can be multiplied to considerable extent when regenerative contribution is allowed to take place. It is well known that this regeneration arises from two main factors as follows.

The current, I_2 , circulating in the plate circuit, gives rise to an inductive voltage E_2 across the primary of the transformer, L_2 . This voltage, reacting upon the grid input voltage E_1 , thru the tube inter-electrode capacity, C_m , is of such phase relation that it reinforces E_1 and therefore the tube input. This condition may reach a steady state before self-oscillation maintains (giving rise to a contributory regenerative effect) or it may be sufficient to cause actual steady generation, depending upon the design of the various circuits, tube characteristics, etc.

The oscillation or regeneration may be completely eliminated or partly suppressed by one of three methods.

A. We may neutralize the feed-back thru the tube capacity, in any of several manners.

B. We may limit the value of E_2 by loss-stabilizing, or change the characteristics of either the tube or tuned circuit so that steady oscillation cannot maintain or;

C. We may change the phase of E_2 , (by plate circuit design), so that it cannot either reinforce or detract from the grid voltage.

The first of these is the bridge circuit

* Consulting Engineer, 5723 Winthrop Ave., Chicago, Illinois.

method, the second is loss or power stabilization and the third, the zero-reactance plate circuit method. Though representative examples are shown in Fig. 2, this paper does not concern itself with a comparison of the three stabilization methods from the efficiency standpoint. It is fairly true that

variation in any one of which, either aggravates or nullifies the tendency. These are

- The voltage factor of the tube (μ)
- The plate resistance of the tube (R_p)
- The grid-plate capacity of the tube (C_m)

PLATE CIRCUIT STABILIZATION

The resistance of the tube's plate circuit is the resistance to electron flow from filament to plate. It is determined by the applied voltage from the B battery. A variable high resistance in the B line feeding the r.f. amplifier tubes will allow control of applied plate voltage, and therefore as a secondary effect, control of the internal plate resistance. Since oscillation and regeneration are dependent upon the plate resistance of the tube, a variation in tube resistance will vary the regenerative effect and therefore control oscillation.

Figure 3 is a curve showing the characteristics of the average UX-201-A tube, which is used as the amplifier. As the plate voltage applied is varied the internal plate resistance naturally also varies, in the manner shown. While this variation is automatic when the high resistance (oscillation control) is varied, it is worthwhile that we have a physical conception of the amount of plate voltage necessary to result in a given plate resistance.

The plate load is varied by juggling the size of the primary coil and its relation to the secondary. This, of course, is not a variable control, and after being once determined in the design of the system, must of necessity be allowed to remain constant.

Almost by inspection it can be seen that

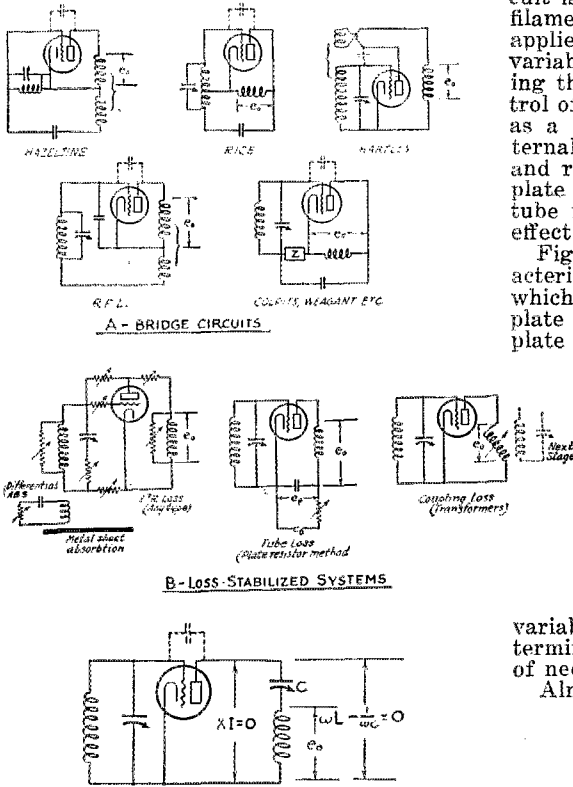

FIG. 2. REPRESENTATIVE EXAMPLES OF STABILIZING METHODS

in a large number of stages the bridge systems are better than the loss-stabilized, while the reverse may be true when only one or two stages are used, (contrasting highly regenerative loss-stabilized stages with well-balanced bridge stages where regeneration is practically nil). The third method (zero reactance plate circuit) is still too new and untried to make a fair statement regarding its merits. So much for the review.

The Loss Method

In the design of a loss-stabilized receiver it should be noted that regeneration and oscillation are due to seven main factors, a

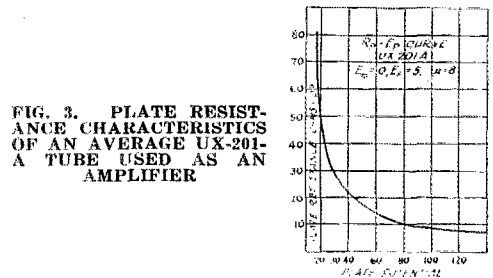

FIG. 3. PLATE RESISTANCE CHARACTERISTICS OF AN AVERAGE UX-201-A TUBE USED AS AN AMPLIFIER

an extreme in either direction is undesirable. Low tube amplification combined with high transformer amplification, or vice versa, will not be as effective as a compromise between the two. A large plate load, which means an efficient transformer, will necessitate an extremely high tube plate resistance to suppress oscillation while a low plate resistance, as represented by a good tube with a high plate voltage will allow only a very small primary

plus mutual inductance which means poor stage transfer of energy. In either case the stage amplification will be low and it is reasonable to suppose that an optimum

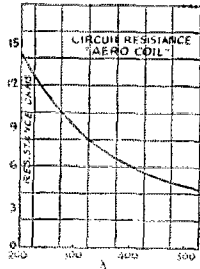
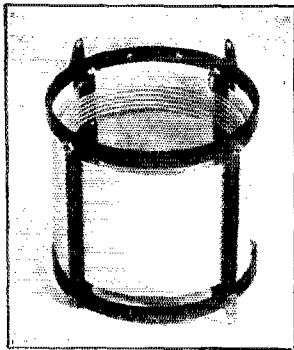

FIG. 4. RESISTANCE-FREQUENCY CURVE OF AN R.F. TRANSFORMER SECONDARY CIRCUIT

relation exists which when determined will give maximum gain under the prevailing conditions. Although this optimum condition is usually reached by a cut-and-try method in the design of such systems its theoretical analysis is interesting and valuable in the determination of the proper



THE R.F. TRANSFORMER USED IN OBTAINING THE DATA GIVEN IN THE CURVES
Photo courtesy Aero Products Inc.

constants. It is unfortunate that receiving systems employing regenerative amplification (as this does) are much more difficult in their mathematical calculation than those employing perfectly balanced bridge circuits or zero-reactance plate loads which need not consider the magnifying effect of regenerative amplification.

In proceeding with the analysis it is necessary to know the constants of the apparatus with which we must deal and their function of variation with other variables. The tuned circuit (as has already been decided) should have a very low power-factor, that is a proportionately high L/R ratio (really the inductance divided by the square root of the resistance) over the useful spectrum. This means an extremely efficient coil of "low-loss" construction is an important factor in transformer de-

sign. The resistance-frequency curve of such a coil is illustrated in Figure 4, and the coil itself in the appended photograph. The inductance of its secondary is 234 microhenries, to tune the spectrum with the usual 350 picofarad condenser.

Figure 5 is a curve showing the non-regenerative voltage gain per stage at 300 meters, of a tube and transformer combination having the characteristics as Figs., 3 and 4, when the plate reactive load (the size of the primary), is varied. These curves may either be calculated from the tube and transformer constants or may be obtained by actually measuring the gain per stage in the laboratory. In the latter case, a resistance rather than an inductive input is used so that the stage will not go into oscillation and confuse the results by

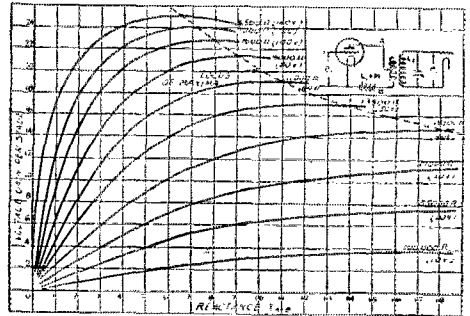

FIG. 5. VARIATION OF GAIN AT DIFFERENT PLATE VOLTAGES AGAINST CHANGES IN THE PRIMARY-SECONDARY RELATION
The curves are made for a wavelength of 300 meters but the same principle may be applied at other wavelengths.

regenerative contribution. Although this regenerative contribution actually figures in the final result, its effect must be considered separately and added later. The family of curves in Fig. 5 was made at different plate resistances (plate voltages) to show the effect of transformer-primary variation and tube-characteristic variation. For example, take the first and highest curve, that of the tube operating at 6500 ohms plate resistance, corresponding to 140 volts on the plate. As we increase the transformer coupling, ($L1$ plus M), the gain per stage rapidly rises until it reaches a maximum of about 25 per stage at 6500 ohms load reactance, after which it slowly falls as the optimum is passed. All the other curves are similarly taken at different values of plate resistances and all rise to a maximum at the value of load reactance corresponding to the tube resistance. (This is an axiom of such circuits.) A line drawn thru these points of maximum gain is a smooth curve and is the locus of maxima.

From an inspection of Fig. 5 it would seem that the most desirable point of op-

eration would be at the highest gain, which would be at optimum primary for the lowest plate resistance. (This would be true in the bridge or zero-reactance plate-load circuits, but is not true in the present case.) Unfortunately, it is found that the stage will go into violent oscillation long before this optimum load is reached, when in the operating condition, that is, with inductive input. It is next necessary to determine the amount of positive reactance necessary to make the circuit oscillate.

Fig. 6 shows curves taken at three frequencies (corresponding to 200, 300 and 550 meters respectively) between the values of plate reactance necessary to produce critical regeneration and tube plate resistance. The curves could be obtained mathematically with a knowledge of the tube and circuit characteristics, but they are modified greatly by practise conditions and therefore are much more easily and accurately determined experimentally, by the method outline in Fig. 6. Taking the 300 meter curve of Fig. 6 it is seen that the tube will oscillate, with the given circuit characteristics, with a positive plate reactance of less than 100 ohms! Note the great discrepancy between this value and the 6500 ohms necessary for the optimum primary. As the plate resistance is increased the amount of reactance to produce oscillation is also increased.

Figure 7 is an amplified section of the lower portion of Figure 5, drawn more accurately and to a much larger scale. The "locus of intersections" curve (which determines the maximum gain) is obtained in the following manner. For each plate resistance (plate voltage) in Figure 5 a value of critical reactance is determined from the curve of Figure 6 and then set upon the corresponding curve in Figure 7. This is (Fig. 5) for 6500 ohms plate resistance, (140 v.), we have, at 300 meters, an allowable plate reactance of 95 ohms for critical regeneration. This 95 ohms is then stepped off as an abscissa on curve 5, projected upward to the 6500-ohm curve and a point thereby determined. This is point A, for illustration, in Fig. 7. For each particular plate resistance a point is thus determined and the locus of intersection drawn in. The curve reaches a maximum which then gives optimum constants.

Similar curves are drawn for other frequencies corresponding to the upper and lower limits of the broadcast spectrum. These optimum values, thus determined, are naturally not the same as those for 300 meters, but it has been found that, since the peaks of these curves are so flat around their maximum points, little is lost by designing the system for best conditions at some point near the middle of the spectrum and merely readjusting

the plate resistor for critical regeneration at other frequencies.

PERFORMANCE OF ONE STAGE

At first glance (Fig. 7) it would seem that the stage gain of these systems even at their optimum point, is extremely low when compared with that for other means of oscillation suppression. (3.75 as against 25.0.) When this is compared with the 10-15 and even 20-per-stage gains shown in some commercial forms of bridge balanced receivers it would indicate great superiority of the bridge circuits. However, it should be remembered that these are non-regenerative figures, which are necessarily multiplied by a large factor representing the regenerative amplification, when the receiver is carefully adjusted. Near critical regeneration the regenerative contribution alone may be as high as 15

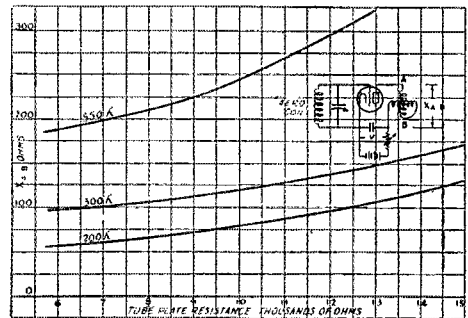

FIG. 6. POSITIVE REACTANCE NECESSARY TO MAKE UX201-A TUBE OSCILLATE
Input from coil shown in photograph; plate voltage variable, voltage factor of tube (μ) equal to eight.

times (Landon and Jarvis, I. R. E. Bulletin, page 749, Dec. 1925). Now 15 times 3.75 gives over 56 volts gain, a very good figure for a single stage, which may be even greatly increased by careful adjustment around the critical value. At the same time the relative selectivity is greatly increased as frequencies slightly off resonance are not amplified nearly as much as are the true resonant frequencies.

These factors indicate reasonable grounds for the statement that a single stage of uncompensated, controllably regenerative radio frequency amplification will perform as well, or outperform a two-stage bridge balanced system which has been perfectly neutralized and gains no regenerative contribution. The statement must be modified when some regeneration (as is most always the case), is used in the bridge system, as it naturally becomes more sensitive and selective under these conditions.

THE MULTI-STAGE CASE

Now if we use two stages of controllable regenerative amplification of the loss stab-

alized variety just discussed, we do not gain a great deal in sensitivity, altho the selectively, or ability to distinguish between interfering stations is greatly improved. The extra stage naturally aids the filtering action a great deal but unfor-

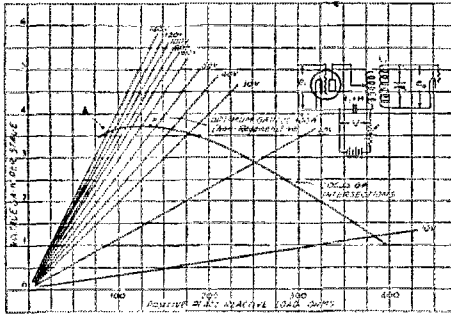

FIG. 7. LOWER PORTION OF FIG. 5 REDRAWN ON AN INCREASED SCALE WITH THE ADDITION OF A CURVE SHOWING THE LIMITS FOR NON-REGENERATIVE OPERATION.

This curve, label "focus of intersections", indicates the gain per stage before the "regenerative contribution" is considered.

unately the additional amplification is not material. This is because the regenerative gain is by far the greater portion of the total amplification in any system of this character, and this factor cannot be usually increased as the number of stages increase. Therefore, although our two-stage system may only show two or three times the gain of a single stage (an amount which is inappreciable to the ear), its selectivity and therefore its general utility is greatly increased.

The reason for limiting the number of stages to two in the foregoing statement is because of the cascading properties of balanced bridge circuits as contrasted with loss-stabilized circuits. Non-regenerative perfectly balanced bridge stages, giving as high as 20 gain per stage may be cascaded to almost any practical number of units. This is not true of regenerated loss-stabilized receivers, as the tendency towards oscillation increases much faster (as the number of stages increases), than does the overall amplification. That is, while the first stage may give fifty or one hundred per stage, the second will give a great deal less, and the third much less than that, and so on. Thus two stages will not give the square of a single stage gain, or three stages give the cube as do the best of the carefully designed bridges, but a great deal less. Increasing to four or five stages may even result in a decrease in overall gain, although the selectivity is much better. This condition is sometimes met in as low as three stages.

Thus far our data has been derived for a single stage (although two have been discussed) with no input losses (antenna or previous stage), and in the practical receiver design it is necessary to consider both the effect of regeneration and of these losses. an analysis, entirely mathematical, would be much more complicated than that of a single stage. Therefore the method shown in Fig 8, an experimental method, was evolved, which easily and quickly gives the proper solution. A two-stage amplifier is shown, with variable interstage primaries and a variable antenna input coil, (which is also incorporated in the commercial model). The input to the antenna coil is measured in the usual manner with antenna and ground resistances thought to be average in effect. The output of the system is measured across the input to the detector tube by the aid of the usual vacuum tube voltmeter. It is necessary to have the detector tube connected, lighted and working into its usual plate load. This is imperative because of the damping effect of this tube upon its transformer secondary circuit, thereby modifying the transformer characteristics.

A series of measurements of input-output ratios is then made, under the conditions of critical regeneration, (or just below), by varying both interstage primaries

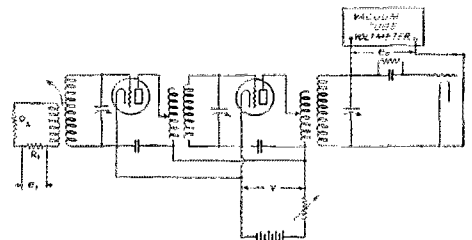

FIG. 8. A MEASUREMENT SET-UP USEFUL IN THE DESIGN OF MULTI-STAGE VOLTAGE-STABILIZED R. F. SYSTEMS

at the same time and varying the two r.f. plate resistances by means of the variable resistor. The curves taken at different frequencies in the broadcast spectrum have the same general form as that of the locus of intersections in Figure 5, and are of the same general order, thus bearing out the previous work. Of course, the complete two stage setup shows somewhat greater gain than the single stage used in Figure 5 but the order of optimum circuit constants is within reasonable limits.

The writer has used this method of designing receivers of the plate-resistance stabilized variety in a number of cases recently and the optimum relations brought about by its use have in every instance resulted in a far smoother and more satisfactory device than those resulting from the usual cut-and-try methods.

Developments in Tuned Inverse Duplex

By David Grimes*

Part 2†

THE first of these two special articles on the new Inverse Duplex System which appeared in January QST, outlined the results of certain tests that proved the fundamental soundness of duplex operation up to the limit of the tube.

ments were developed entirely by laboratory measurements with certain definite objects in view and were never operated on actual broadcasting until the research work was completed. Thus, the various features involving unequal r.f. amplification and uniform selectivity were determined with accuracy.

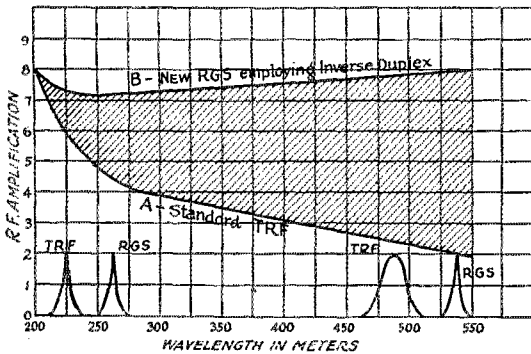

FIG. 1

R. F. AMPLIFICATION CURVES

A General nature of curve obtained from usual R.F. amplifier with fixed coupling.

B Nature of curve obtained by use of automatically increasing feedback in the R.G.S. circuit. The small curves labeled "TRF" and "RGS" show in a qualitative way the difference in the selectivity of the two schemes at low and high ends of the tuning range. They are simply resonance curves such as would be obtained with the tuning controls fixed and the input constant as to power but varied as to frequency. It is to be understood that these curves do not relate to the scales on the main diagram.

The radio frequency circuit was given first consideration. A laboratory or study was conducted on many of the more popular types of r.f. circuits. Certain defective trends were analyzed. With these limitations tabulated as shown below, a systematic series of experiments was started to obtain sufficient data with which to suggest improvements. The common troubles in the standard r.f. circuits were these:

1. Unequal r.f. amplification or pick-up at different wavelengths resulting in satisfactory reception of some stations but poor results on others.
2. Critical operating adjustments, necessitating considerable skill before best results were obtainable.
3. Lack of uniform selectivity over the tuning range stations so that overlapping of stations occurred on certain sections of the tuning dials.

Curve "A" in Figure 1 suggests the r.f. amplification efficiency of some common types of tuned radio frequency circuits. It is seen that such a circuit performs excellently around

Interference between the radio and audio currents being amplified thru the same tube was shown to exist only when the instantaneous voltages on the grid of that tube exceeded the negative grid bias, thus running the grid potential positive. By employing the standard grid bias on the duplex stages and using a straight audio power amplifying tube before the loud speaker, sufficient audio output could be obtained to overload the power tube, itself, before any modulation or overloading, occurred in the duplex tubes.

This article discusses the new radio and audio circuits developed for duplexing and completes the information by showing the application of these circuits to the new R.G.S. receiver. These new circuit arrange-

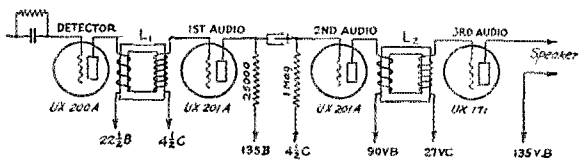

FIG. 2

THE BASIC AUDIO CIRCUIT WHICH APPEARS IN MODIFIED FORM IN THE R. G. S. RECEIVER

200 meters and that even low-power short-wave stations are picked up from great distances. At the longer wavelengths the amplification efficiency drops off very abruptly. This is caused mainly by the decreased efficiency of the fixed coupling in the tuned transformers at the longer waves. The tendency of the primary windings to load the plate circuits also helps at the short waves, while it is insufficient to produce much effect on the longer waves.

Several attempts in the past to correct

*Grimes Radio Engineering Co. Inc., Grasmere, Staten Island and Long Island City, New York.

†The second of two articles, the first appeared in the January QST.

plifier, the primary connections of the audio transformers may be so poled, or phased, that the plate currents flowing thru the common B-battery or eliminator will oppose one another. Thus the feedback may be made slightly opposing, creating stability by opposing any tendency for audio howl. In any form of straight resistance or impedance coupling this reversal of phase cannot be obtained.²

A pleasant surprise was found in the improved types of audio transformers now on the market. It is of course well known that by utilizing an increased amount of iron and therefore an increased primary impedance the long desired bass notes have been made to appear without sacrificing the high pitches. The one lacking essential in transformer coupling was thus supplied. But even with "perfect" transformers con-

the familiar Rice neutralization arrangement the distortion was overcome and good output with good quality was obtained. Unfortunately such an arrangement was complicated and impractical.

An ideal solution that is simple was found in a combined audio circuit as shown in

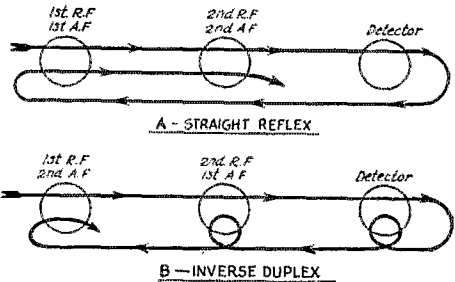

FIG. 5 THE INVERSE DUPLEX ARRANGEMENT SHOWN AGAIN TO EXPLAIN THE NEED FOR THE FILTER SYSTEM

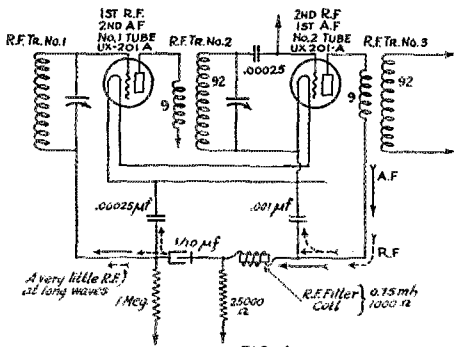

FIG. 4

THE ACTION OF THE R.F.-A.F. FILTER CIRCUIT IN THE R. G. S. RECEIVER

nected with proper primary phase, no more than two stages of audio could be obtained without a tendency toward distortion. Now it is undesirable to attempt to obtain the needed output with only two audio stages as the detector tube must be forced which inevitably results in inferior quality. It is better to keep the r.f. input to the detector somewhat lower and to employ an extra stage of audio amplification.

When building a compact set the distortion with three transformer stages was found to be due to audio regeneration between the successive audio stages back thru the plate-grid capacities of the tubes in the manner so well known in radio frequency circuits. By winding a split primary on the audio transformers and employing a neutralizing condenser back to the grid in

Figure 2. Here a resistance-coupled stage is placed between the two transformer stages, so that grid and plate resonant feedback is not possible.

From Figure 2 it will be seen that the first audio tube, though having a high inductance L_1 , in its grid circuit is unable to regenerate noticeably because its plate load is a 25,000-ohm resistance. In the same way the inductance L_2 in the plate circuit in the plate of the second audio tube has only a resistance in its respective grid. A plate resistance of only 25,000 ohms was adopted in order to approximate the internal impedance of the amplifying tube and thus obtain a condition where the external impedance is equal to the internal impedance—a matching necessary for maximum efficiency. By placing 135 volts on the plate resistance of this tube, about 70 volts actually reaches the plate. This then, is a resistance stage which actually amplifies in addition to its stabilizing effort.

The proper ratios for the audio transformers were next considered. Somewhat contrary to accepted practice, a low ratio (2-to-1) audio transformer was found to be by far the best, right after the detector. Low-ratio transformers are ordinarily obtained by merely winding more primary turns than when building a higher ratio. Thus, by more primary turns, the ratio between primary and secondary turns is decreased. At the same time the increased primary turns raise the impedance of the transformer, thus making it more nearly match the high impedance of the detector plate circuit—a condition already mentioned as necessary for maximum amplification.

The last audio transformer ratio is also a reversal of standard practice. Since the

2. The effect can in practice be removed by the use of by-pass condensers and iron-core chokes. To be fully effective these must be rather large and somewhat costly. Since they also complicate the set it seems justifiable to consider a circuit change to avoid them.—Tech. Ed.

advent of the new UX-171 type of power tube, it has been realized that the term "power tube" is in one sense a misnomer. This new tube does not create powerful signals but is designed to handle them without distortion if such signals are delivered to it. Its amplification factor is in fact less than that of the standard 201-A type. The

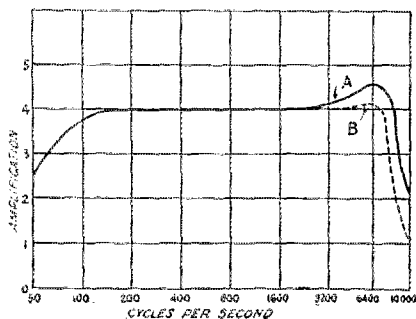

FIG. 6

CURVES OF SPECIAL AUDIO TRANSFORMER DESIGNED TO WORK WITH BYPASS CAPACITY

Curve A shows operation without by-pass and curve B shows operation with .00025 μ fd by-pass across secondary. In the R. G. S. receiver this by-pass is the grid condenser of the 2nd r.f. tube. There is also a primary by-pass but its effect is important though in the same direction.

UX-171 has a "mu" of about 3 as compared with about 8 of the UX-201-A tube. To compensate for this reduced amplification so that the output on weak stations is not too small, it is necessary to employ a higher ratio audio transformer. The 6-to-1 ratio was found to be entirely satisfactory in quality, while entirely making up for the reduced "mu" of the 171.³

THE R. F. CIRCUIT AGAIN

The new audio combination was now satisfactory. Pending a better r.f. arrangement, a simple tuned radio frequency circuit was employed using only a limited number of turns in the primaries of the transformers; so that oscillation would just not occur at the lowest wavelength setting of the tuning condensers. No attempt at balancing was made. The r.f. amplification curve of such a circuit is shown in Curve "A" in Fig. 1. The total circuit then consisted of an audio amplifier known to be good, combined with a radio amplifier known to be weak at the upper wavelengths but quite operable otherwise. The mere fact that the audio energy was put back thru the same tubes should not (as has been shown) damage the final result. Using the connections of Fig. 3 (less the r.f. filter coil) the performance of the audio amplifier did in fact remain good up to the limit of the

tubes. None the less there did arise a difficulty in the r.f. end of the circuit. To make a long story short, the resistance coupling is just as effective at radio frequencies as at audio frequencies. Now this coupling connects the output of the first audio tube to the input of the second audio tube and as an audio coupling device, functions exactly as it should. The difficulty arises in the fact that this resistance coupling also passes radio frequency from the output of the second radio tube back into the input of the first radio tube (these same tubes being the first audio and second audio respectively because of the Inverse Duplex arrangement, see Fig. 5). This obviously constitutes an r.f. feedback circuit which will be either aiding or opposing according to the polarity of the primary connections

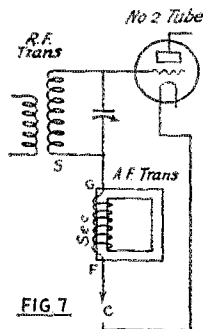

FIG. 7

USUAL SERIES METHOD OF CONNECTING R. F. AND A. F. TRANSFORMER SECONDARIES TO A REFLEXED TUBE SHOWING THAT THE ROTOR OF THE TUNING CONDENSER CANNOT BE BROUGHT TO FILAMENT VOLTAGE

on the middle tuning coil. In the first case, reception is ruined because of r.f. oscillation over the entire tuning range and, in the second case, sensitivity is lost because of the strong feedback.

In an effort to overcome this, a large r.f. choke coil was inserted in the resistance coupling in the same position as the r.f. filter coil shown in Fig. 4. This had no effect on the audio currents passing thru in their proper sequence but entirely prevented this coupling from being an r.f. feedback path because this choke coil was a very effective one. The difficulty had been overcome, but the r.f. circuit was still the same old simple arrangement giving poor amplification on

3. The plate impedance of a detector tube is always very much higher than that of the same tube used as an amplifier, especially if the plate voltage of the detector is low. In the present case the detector tube is operated at 22½ volts while the 2nd audio tube operates at 90 volts. It is evident therefore that a very much smaller primary impedance will be satisfactory in the 2nd audio transformer than in the first.—Tech. Ed.

the long waves. An effort was made to reduce the size of the r.f. choke in order to determine the minimum inductance necessary to prevent objectionable feedback—and one of the most unique radio frequency circuits yet produced, was literally tumbled upon!

The r.f. primary phase on the middle tuning coil (R.F. Tr No. 2 in Fig. 4) was first connected so that aiding feedback might be obtained thru the resistance coupling. Then the size of the r.f. choke in the resistance coupling was designed so that together with the .001 μ f. fixed condenser in the plate of the No. 2 tube and the .00025 μ f. fixed condenser in the grid of the No. 1 tube, the entire combination comprised a filter circuit (as shown in Fig. 4) such that virtually no reinforcement was obtained at 200 meters while an ever-increasing amount was acquired as one tuned up toward the 550-meter setting. To obtain this effect it was found necessary to use a filter choke wound with nickel-chromium resistance wire to an inductance of .75 millihenries and a resistance of approximately 100 ohms.

The overall r.f. amplification of the heretofore simple r.f. circuit was thereby changed from something like Curve "A" to something like Curve "B" in Fig 1, the improvement being automatic in operation. The shaded area between the two curves shows the increase in amplification obtained entirely by means of reinforcement—not by any system of increased coupling in the transformer. The circuit that would meet not only the equal-amplification requirement but also the uniform selectivity demand as well, was a fact. Any reinforcing or feedback action acts as a "negative" resistance, therefore the tuning is sharpened at the long waves and a seemingly paradoxical situation exists—more amplification with greater selectivity at the longer waves. Regeneration as "negative" resistance is thus applied in progressively increasing amounts to compensate for decreased coupling efficiency at the longer wavelengths. The filter is not critical, resonant, nor oscillatory. The tuning of the stages is not shifted.

Now that a satisfactory radio and audio circuit has been developed, there still remained a few finishing touches to be put on the duplex features. Running the circuits thru the same tubes created a few problems that had to be solved in addition to those presented by the circuits them-

selves when connected in a straight sequence without duplexing. The r.f. currents had to be passed back to filament around the audio apparatus because they would not pass thru the large inductances. For this purpose, the small fixed by-pass condensers are employed in grid and plate circuits. These by-pass condensers also tend to pass the highest audio pitches as well and being directly across the audio apparatus, tend to cut down these high notes. To prevent this from interfering with the distinctness, special audio transformers were selected that possessed an excess of amplification at the high notes. By employing such transformers, the by-pass condensers may be

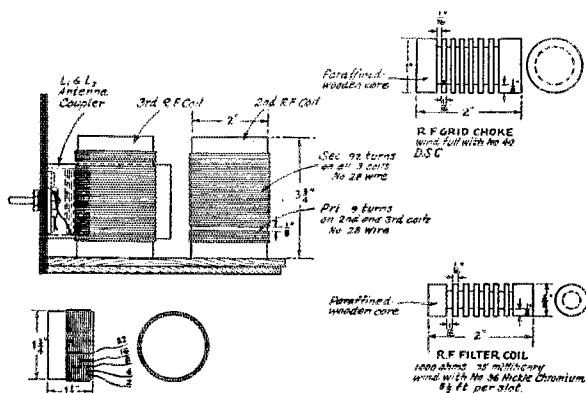

FIG 6
CONSTRUCTION OF THE TUNING COIL AND THE CHOKES

The antenna coupler L1-L2 projects back from the panel. It has a secondary L2 wound of 92 turns of No. 28 wire on a 2" tube, inside of which is slipped (at the filament end) a primary L1 wound on a 1 1/4" tube as shown in the separate sketch below. The construction of the other r.f. transformers can be seen at a glance. Their secondaries are like L1 but the primaries have 9 turns only, located as shown, with 1/4" spacing from the secondary. Single cotton or silk and cotton insulation may be used. The tuning condensers are all three of 350 μ f. capacity. The last one (detector input) has a small "makeup" or vernier condenser connected across it.

used for r.f. by-passing without effecting the quality of audio reproduction. This is illustrated in Fig. 6. The high frequency peak on the *last* audio transformer is *not* cut off by a by-pass condenser, but is used to compensate for the cutting of the high frequency side bands by the high selectivity of the r.f. circuits. Thus, good audio quality is obtained in the face of extreme radio frequency selectivity.

The next special Duplex problem was body capacity on the middle tuning condenser. Reference to Fig. 7 will show that this condenser hung at the level (electrically) of the grid terminal of the first a.f. transformer when that transformer's secondary was connected in the usual manner i.e. in series with the r.f. secondary

feeding the same tube. Approaching this tuning condenser was practically the same as touching the grid post of the first audio transformer. A squeal always resulted. To solve this particular difficulty, it was decided to shunt feed the audio currents to the grid of the No. 2 tube thru an r.f. choke coil, thus keeping the audio currents entirely out of the middle tuning condenser and coil. This tuning condenser could then be connected with the filament and did not hang on the grid post of the audio transformer. Considerable care must be exer-

eter across the secondary of the first audio transformer. The adjustment of the tapped antenna primary does not affect the audio circuit, neither does the potentiometer, in any manner, control the radio.

The antenna primary is tapped in geometric sequence. The taps are taken off at turns 2, 4, 8, 16, and 32. The primary consists of 32 turns and is wound as shown in Fig. 8. The proper operation of this tap switch is essential. For maximum selectivity, the primary switch should be placed on tap 2 or 4. In any case, this setting always gives the best results for the shorter broadcasting waves as it tends to tune the antenna to those frequencies. As the longer wave stations are tuned in, higher taps should be used, unless the need for extreme selectivity prevents it. Shifting this antenna switch, necessitates a change in the tuning position of the first tuning condenser only. Furthermore, only a few antenna turns should be employed on local stations so that the detector tube will not choke out the bass notes. By keeping the radio energy down, good quality can be expected from the detector.

In addition to this control of radio energy, it has been found highly desirable to provide regulation of the audio volume. By means of the potentiometer arrangement shown in Fig. 3 this can be done without effecting tuning, sensitivity, or audio quality. This also enables the operator to keep the strength of audio signals below the over-loading point of the amplifying tubes. Under ordinary conditions, the potentiometer should be set at the half-way position and boosted only on

weak signals when greater volume is desired. If this control is boosted on local reception, the power tube will first overload, giving poor quality and then the duplex stages and resistance stage will overload producing a choking noise. The remedy is to reduce the setting of the audio potentiometer. These overload points do not occur until more output is obtained than can ordinarily be tolerated.

The circuit developments discussed in these articles have been incorporated in the so-called R.G.S. receiver which consists of certain recommended parts that have been tested and found to perform satisfactorily according to the principles outlined above. These parts have been arranged in many different panel layouts herewith. The arrangement of Fig. 9 is very satisfactory. It will be noted that the receiver is arranged for two control operation by means of a

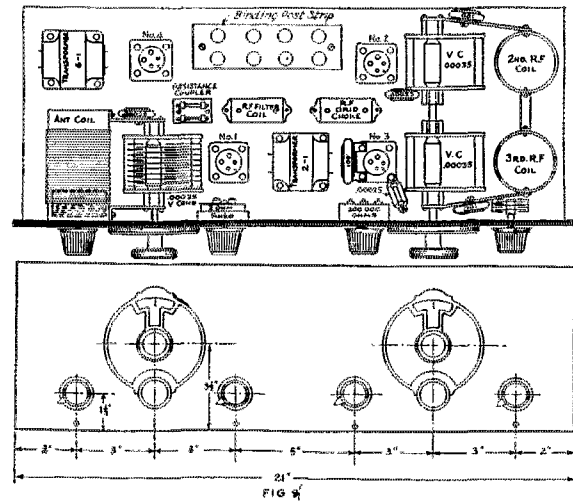

ARRANGEMENT OF PARTS IN THE R. G. S. RECEIVER

By referring to the two views alternately it can be seen that the left National dial controls the antenna coupler tuning while the right one operates a 2-gang condenser which tunes the 2nd and 3rd r.f. transformers. The small controls can be identified in the same way and are, from left to right, antenna tap switch, filament rheostat, audio input control potentiometer and "make-up" vernier condenser which one can usually "set and forget."

cised in design of the choke used here. It must have an inductance of at least 18 millihenries with very low self capacity. Such a grid r.f. choke must be wound in slots as shown in Fig. 8. While there are several desirable methods of controlling the audio output in an ordinary circuit, there is only one proper way for this to be done in the new I.D.S. The radio amplification cannot be cut down by dimming the filaments in the r.f. tubes because this would also shut off the audio amplification. A filament potentiometer cannot be employed to regulate the radio amplifier as this same device would ruin the audio quality. The controls for the radio and audio currents must be kept entirely out of each other's circuits. Thus, the r.f. energy is controlled at its source by means of a tapped antenna primary, while the audio volume is regulated at its source by means of a potentiom-

double condenser. This double condenser is equipped with a small vernier to compensate for any minor variations that may occur in coils, condensers, wiring or tubes.

Perhaps the only unusual arrangement in the layout is the location of the second and third tuning coils. It would appear that all sound engineering principles had been violated in mounting these parallel and so close to-gether. However, this has been done deliberately. The coils are mounted reversed with the grid end up on the rear, or second coil, and the grid end down on the third, or detector, coil. This gives some slight "negative" or opposing, feedback at the short waves without effecting the long waves greatly. By means of this opposition, the circuit is completely stabilized at the 200-meter setting where instability might arise due to the absence of shielding. By employing this arrangement and by feeding the first audio directly to the grid thru the grid r.f. choke, *no shielding is necessary.*

Quartz Crystal Mounting

IF YOU have had to buy your own brass plates and carefully and laboriously cut them to shape and still more carefully grind them flat, you will appreciate the announcement that a ready-made quartz crystal mounting is now available. The device

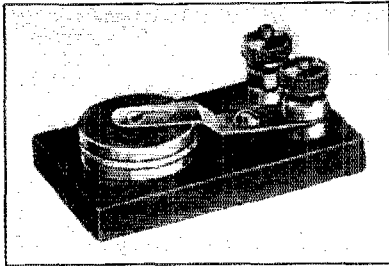

is mounted on a small bakelite block and carries two binding posts connected to the two plates. The lower plate is bolted into position while the upper plate is pressed against the crystal by means of the long spring whose tension can be adjusted. To keep the top plate in place on the crystal a small hole is drilled in the center of the plate, the spring carrying a notch which fits into this hole. Sufficient space is provided in the mounting to take care of all crystals up to about 600 meters. The mounting can be readily modified for thicker crystals. This mounting comes from General Radio of Cambridge 39, Mass., and is known as their type 356 holder. It will find a ready welcome in every crystal-controlled shack.

—J. M. C.

Standard Frequency Schedules

CHANGE IN QST SCHEDULES

Examinations at Massachusetts Institute of Technology have necessitated the omission of two of the schedules given on page 8 of our January issue, causing the schedule to read as follows:

Date	Schedule	Station
Feb. 11	A	9XL
Feb. 13	C	1XM
Feb. 13	C	9XL
Feb. 25	B	9XL
Schedules for 9XL not known beyond this date as yet.		
March 6	C	1XM
March 11	A	"
March 25	B	"
April 3	C	"
April 8	A	"
April 29	A	"
May 1	C	"
May 13	B	"

In the above the meanings of schedules A, B & C remain as before, that is to say,—

3 minutes—QST QST QST u (Station call letters).
 3 minutes—5 sec. dashes broken by (station call letters) every half minute.

1 minute—announcement of frequency in megacycles per second (8.75 megacycles per sec. is sent as "8 r 75 MC").

1 minute—announcement of next frequency in megacycles per sec.

(Figures are frequencies in MEGACYCLES per sec.; approx. wavelengths in parentheses)

Friday Evening Schedules				Sunday Afternoon Schedules			
Eastern	Standard	Time for		Eastern	Standard	Time for	
	1XM				1XM		
Central	Standard	Time for		Central	Standard	Time for	
	9XL				9XL		
Time (PM)	Schedule	Schedule		Time (PM)	Schedule	Schedule	
	f λ	f λ			f λ	f λ	
8:30	3.50 (85.7)	6.50 (46.1)		3:00	10.0 (30.0)		
8:42	3.60 (83.3)	6.75 (44.4)		3:12	12.0 (25.0)		
8:54	3.75 (80.0)	7.00 (42.8)		3:24	14.0 (21.4)		
9:06	3.90 (76.9)	7.25 (41.3)		3:36	14.5 (20.7)		
9:18	4.00 (75.0)	7.50 (40.0)		3:48	15.0 (20.0)		
9:30	5.70 (52.6)	7.75 (38.7)		4:00	15.5 (19.3)		
9:42	6.50 (46.1)	8.00 (37.5)		4:12	16.0 (18.7)		
9:54	7.00 (42.8)	8.25 (36.3)		4:24	18.0 (16.7)		
10:06	7.50 (40.0)	8.50 (35.3)		4:36	20.0 (15.0)		
10:18	8.00 (37.5)	8.75 (34.3)					
10:30	8.50 (35.3)	9.00 (33.3)					

QSL

All those using the transmissions from 1XM, WWV and 9XL are urged to *acknowledge the transmissions*, NOT to the stations but to Experimenters' Section, A.R.R.L., Hartford, Connecticut. If you have at any time during the operation of these stations made use of their service please advise us, as it is imperative that we find out what portions of these transmissions are most used and what territory is being covered. Depending on the result of this request the system's development will be changed to meet the need.

Note especially that the letters and cards are NOT to go to the Communications Department but to the Experimenters' Section, which is in constant touch with the O.W.L.S. Committee.

Rotten Reasons

By The Old Man

Old-Timers in the League will give a yelp of joy at the very word "Rotten", recognizing an "Old Man" story. To our newer brethren a word of explanation may be necessary. "The Old Man" is QST's unknown contributor, the mystery of whose identity and location has never been solved. With unerring aim and caustic wit he turns up to view the things that are "rotten" in amateur radio, and his lessons go home because he entertains us at the same time. The "Old Man" stories of earlier years are amateur classics. It was in them that the famous amateur terms Wouff-Hong, Rettysnitch, and their associate instrument, the Blifsky, were given birth. It has been a long while since we heard from T.O.M. Welcome back, O.M., and let's hear more from you.—Editor.

SAY, Son, I've just got to get this off my chest. I've been sitting around for a long time now, listening and thinking, and watching you young ones run things, and seeing amateur radio bulge and shrink in spots, until I'm likely to bust if I don't blow off steam. Poor little Kitty has had a bad time of it lately, and I've got where "I ain't fit company for no

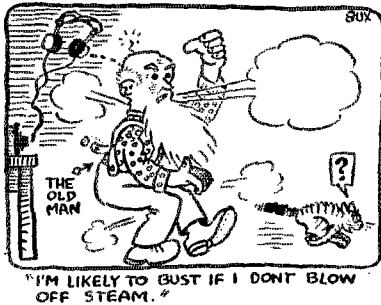

and that the sooner we settled the matter the healthier it would be for all concerned. He has grown older, this old-timer war-horse president of ours, and his methods, while not exactly partaking of those of the prize ring, yet are a bit old fashioned. He still knows how to conduct a radio club meeting, and don't anybody forget it. You are not likely to, for when you go home you feel that you have had a narrow escape.

Final Authority was there with his glasses and his professional manner, and of course he had the cure for what is wrong with amateur radio. He is older, but he hasn't smoothed out any to speak of in recent years. He looks up at the ceiling just as much when he talks. He's just as long-winded, he gets just as involved in complexities as in the early days, and he still suffers from the superiority complex. He roils Radical up just the same as in days of yore, and Radical fidgets in his seat in the same dear old manner that he used to when we smashed up the furniture at every meeting.

man," as the profusely perspiring lady said to the gentleman at the dance.

We have had an Old Timers Meeting of the remains of our old Radio Club out here, and we ventilated a certain subject very thoroughly. It's the points brought up at this meeting that lead this old bundle to take his pen in hand again.

We persuaded our old time president to preside at the meeting, which he consented to do only after we had sent over to the blacksmith shop and fetched him a maul, that he might be able to wallop the desk in the good old way and keep order. He glared around at every one present with the delightful belligerency of by-gone days, and it really gave us other old-timers quite a kick. He outlined in his characteristic ladylike manner the object of the meeting, to the effect that we were here to find out wattenel was the matter with amateur radio

Final opened the ball and took about twenty-five minutes to get his trouble out of his system. His motion was that amateur interest had appeared to flag for the reason that amateur wave-bands were now separated, that the gang on the eighty-meter band was not on speaking terms with the bunch on the forty-meter band, and those on the twenty-meter band were so blamed high-brow that they thought that persons using a frequency less than 1500 kilocycles were so depraved that they were not fit to associate with. This and a lot of highfalutin hogwash about the higher intellectual plane of radio communication today and how we have become amateur physicists and radio research engineers and similar uplift bunk pretty nearly drove some of us to plot murder. Having relieved his system, and satisfactorily impressing us that he was a deep-water thinker, Final sat down impressively and wiped his eye-

glasses very carefully. Our old-time president gulped a couple of times and from force of habit reached for his maul, and you could see he was trying his darndest to formulate some kind of an intelligent comment upon Final's speech. But Final had failed to provide a handle on any of his ideas, and when there isn't any handle to get hold of, there isn't any use searching

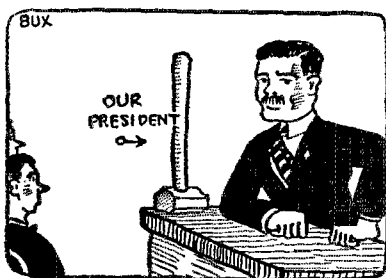

HE GLARED AROUND AT EVERYONE PRESENT WITH THE DELIGHTFUL BELIGERENCY OF BY-GONE DAYS

around and trying to find one. The president simply gave up and took it out in glaring around at everybody.

Everybody expected Radical to crash through about this time, but evidently he was not ready. Somebody else got up and feebly suggested that our foundation was built upon telegraph operating and after all it was the training of proficient radio telegraph operators that gave us amateurs our pull with our Government, and for him he got more fun handling traffic in a snappy manner than fooling around with circuits invented by people with impaired digestions.

This inflamed another nitwit, and he got up and got all haired up over the CQ business, and the DX hounds and the lamentable falling off in message traffic, and the unspeakable ethics of those creatures who failed to deliver radiograms. He got himself hopelessly off the track, but he succeeded admirably in working himself into a white heat of indignation and in tearing his passion to tatters. His ideas hadn't any handle on them, and so silence again fell and broke a hole in the floor. All this was too much for poor Final, and realizing that the universe was tottering and the stellar system was upon the verge of going completely cuckoo, he arose and after majestically clearing his thin but gentlemanly throat, he opined that we must keep clearly in mind what our problem was. Our major problem, according to Final, appeared to be to maintain the intellectual interest in the diverse determinations that must be made if we are to continue in making available to civilization the manifold advantages that were obviously on the threshold in radio. Waving his awkward arms, he pointed to the skip-distance business, and

how we should go about finding out what frequencies would offer skip distances which were ultra-terrestrial. Then there were the cork-screw waves. He pointed out that there were reasons for suspecting that these cork-screw effects might not have the skipping sickness at all. Amateurs certainly could not aver that interesting work was lacking when there was the cork-screw stuff lolling around waiting for somebody to come and fondle it. Then there was the transmission of pictures. We certainly must have picture transmission by amateur radio if we hope to get a ringside seat in the radio hereafter. Then there was the transmission by amateur radio of the moving picture, and certainly that was fraught with mental gymnastics interesting enough to suit the most fastidious. Then came radio television, waiting for us amateurs to televish each other. In a burst of gentlemanly restrained and impressive oratory, Final finished his peroration with a deadly argument to the general effect that anybody who thought that there wasn't anything more for the amateur to do in radio needed to have the Duco scraped off his brains, or words of like import.

Everybody took a deep breath when Final sat down. Then Radical arose, and we knew this was the knock-out round. He started off sort of gentle-like about the flagging-interest business and the traffic handling, as if he didn't want to scare Final out of the room before he had time to get his axe out. He paid his respects to the CQ imbecile and the DX atrocity, and then he proceeded to unlimber. Interest was not flagging. On the contrary, we amateurs were more interested in radio than we ever



FINAL AUTHORITY WAS THERE WITH HIS GLASSES AND PROFESSORIAL MANNER

were. How else could anybody account for the fact that the whole civilized world was our playground, these days? He said that any amateur who couldn't work every continent on earth in a single night must have sleeping sickness. That QST was more interesting than it ever was, and that our A.R.R.L. was bigger and better and stronger than it ever was, and that the

commercial companies thought more highly of the technical abilities of the amateur than they ever did; and looking straight at the back of Final's head, he said that while some of us might be interested in establishing the electrical constant of radio television, there were others of us who took an equal interest in getting continuous-wave high-frequency telegraph signals so perfected that one didn't have to employ a bloodhound to chase around through the ether and keep them in the head phones. Message traffic of the old character could not be handled by existing amateur stations because of unsteady frequency, and just as soon as we found out how to make signals that would enable us to make solid copy on a long run of stuff, message traffic would come back. Not that the old kind of cheap guff traffic would return, but that a new form of better traffic would come into style, and would give all the kick that we ever got with a spark, and then some.

Then he read the riot act about the experimenter and the operator. He asked if it was good business to spoil a good operator trying to make a bum research engineer or to spoil a good research engineer trying to make a bum telegraph operator out of him. He didn't think it was. It might not be so intellectual, but it seemed to him to be more sensible to recognize that we amateurs had different tastes, that some of us preferred to do one thing and some of us another thing. And that instead of yowling around about flagging interest, we ought to be organizing experimental work and developing something steady for our operating end to telegraph with.

Some twenty-five started to talk all at once here, and the president began to threaten them. The thing ended with no casualties and no smashed furniture. When we got outside in the cool night air, and found that we were all accounted for, we decided to sit right down and write Warner and Handy all about the matter.

This is my letter, and I feel better now I have it off my chest. I can light the old pipe now and get on the air and see what they are doing down in South America. I leave it for you boys in Hartford to pass on this thing. It's a long time since this old hoss has fired up enough to write into Headquarters. He hopes all the gang are still QSA. GN and 73 all around.

—T. O. M.



Multi-Contact Control Switches

THERE are many uses to which low capacity multi-contact switches of the telephone type can be put. The usual arrangement of the simple "off-on" A-battery switch has been available for some time. Lately additional contacts have been added to take care of the A and B sub and more recently there have been added quite a few additional contacts for all variety of circuit manipulation. The two switches

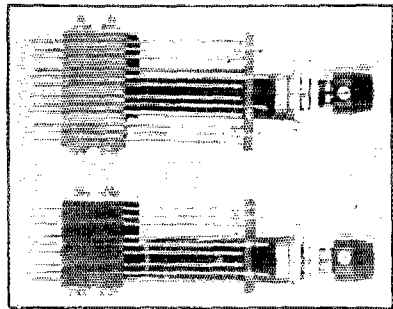

shown in the illustration should be useful in a ham station in many places. One of them is a nine-spring affair equal to a three-pole double-throw switch and the other a twelve-spring type equivalent to a four-pole double throw switch. The springs are of very heavy material with inserted silver contacts. The insulation is micarta. The whole switch is mounted on a telephone jack frame, being arranged for single hole panel mounting. The number of combinations of uses for such a rig is almost infinite. The twelve-spring switch can be used to cut in one or two stages of audio frequency amplification, killing the filament of the unused tube and in the "off" position turning off all filaments. This makes a very handy arrangement since the telephone plug does not have to be shifted from one jack to another when changing stages. These switches are available in a large number of combinations from the Yaxley Manufacturing Company of Chicago, Ill.

—J. M. C.

Strays

As further proof that the hams are running broadcasting stations, we find from 2DY that the well-known WJZ boasts amateur operators from four different radio inspection districts. And they all operate at 2DY also.

A D.C.-A.C. Crystal-Controlled Transmitter

By John M. Clayton, Assistant Technical Editor

THE problem of the high-power crystal-controlled transmitter is a difficult one unless one is endowed with plenty of the goods of the world and can afford kilowatts of high-voltage direct current. Even then when we have spent a thousand dollars or so on a 500-watt crystal-controlled transmitter, the note resulting is not always entirely desirable from an operating standpoint. It is *too much* good d.c. to be easy for the receiving operator to pick up readily or in some cases to follow nicely in copying. And again the d.c. crystal-controlled sets sometimes have an unhealthy habit of partially fading, resulting in a note that appears to jump from one frequency to another, or varies greatly in intensity, although in reality it may be just as steady as one could desire when leaving the transmitter.

With all of these thoughts in mind, and especially with a lean and skinny pocketbook even after Xmas, it was decided that we *would* build a semi high-power crystal-controlled transmitter which would give a note with sufficient modulation to make it desirable from an operating standpoint. The result is the transmitter which will be briefly described in the following lines; and incidentally the transmitter which will probably be used as the A.R.R.L. Headquarters' station 1MK 40-meter set.

If we build up a full-wave a.c. oscillator using a single tube on each side of the 60-cycle high-voltage supply, we obtain a note which is familiar to all of you—a note that is certainly not unpleasant to copy—one which pounds through much better than the average chemically rectified “d.c.” transmitter with the average amount of filter hooked on. If, now, instead of using the two tubes as oscillators, we use them as power amplifiers and excite their grids from a smaller tube which is oscillating with crystal control and d.c. plate supply, we get a much improved note and one which is infinitely more steady, and still at the same time has sufficient modulation to carry well and lend itself to being copied easily. This, briefly, is the present transmitter.

While the particular one which is at 1MK uses a couple of quarter Kw. 204-A's operated as a.c. amplifiers and an under-loaded 203-A acting as a d.c. crystal-controlled oscillator, this approximate ratio of tubes can be maintained for lower powers. Two a.c. operated 50-watt amplifiers can be controlled by a single d.c. 210

crystal-controlled, or two 210's as a.c. amplifiers can be excited by a 201-A with d.c. and crystal control.

There is nothing unusual in the circuit shown in Fig. 1. It is the “standard” crystal oscillator arrangement plus the usual full-wave a.c. back-to-back self-rectified oscillator slightly modified to act as an amplifier instead of an oscillator. The crystal-controlled tube is a 203-A supplied

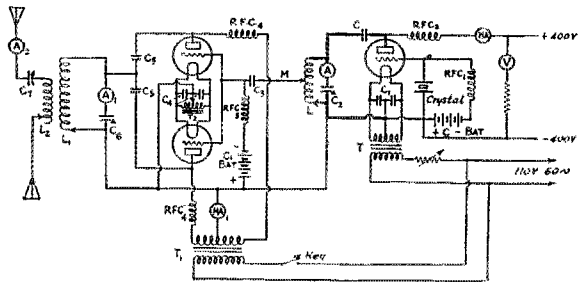

FIG. 1 THE COMPLETE CIRCUIT

with from 350 to 400 volts of pretty good “d.c.”. In 1MK's case the d.c. comes from a small Escro motor generator minus any filter. The crystal oscillates (yep it *does*) in the 80-meter band and the amplifier picks off the 2nd harmonic of the crystal, giving a signal in the 40-meter band. In order to make the second harmonic as pronounced as possible the grid biasing voltage on the oscillator is from 90 to 135 volts. This voltage could even be raised with considerable advantage.

The plate circuit choke (RFC2) is a standard R.E.L. choke coil. The grid-circuit choke RFC1 must be a home-made and home adjusted one, having a natural period equal (preferably) to the period of the crystal itself. Condenser C, the plate blocking condenser, and condensers C1 are standard Sangamo receiving fixed condensers having capacities of 1,000 μ fd. each. When wiring the oscillator it is important that the leads shown in heavy lines in Fig. 1 be made as short and direct as possible. The filament supply by-pass condensers (C1) should be located right at the filament terminals of the socket. The variable condenser C2 in this case had a maximum capacity of 500 μ fd. It was one of the six-bit Cardwell condensers of the receiving variety. A lower capacity is desirable from the standpoint of ease of adjustment since the tuning is quite critical with a condenser of this size. It was used

here so that the leads to coil L could be soldered in place and all oscillator tuning adjustments made by varying the capacity of this condenser alone. Ammeter A is a thermocouple type having a scale of 0 to 5 amperes. This meter greatly facilitates the adjustment of the oscillator, it being

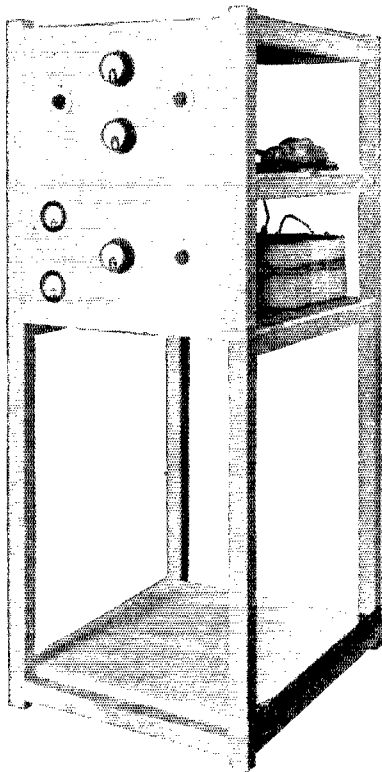

FIG. 2 A FRONT VIEW OF THE TRANSMITTER

operating properly when the current in this circuit is at a maximum.

Separate filament transformers are used on the 203-A and 204-A's although their filaments could have been heated from the same source. In that case it would be advisable to provide resistances of equal value in each leg of the 203-A filament circuit.

The power amplifier tubes pick up grid voltage by means of tap M on the oscillator plate coil L. The grid condenser C3 as well as the plate blocking condensers C5 have capacities of 1,000 μ fd. each. The filament by-pass condensers C4 are also of this size. The radio frequency chokes RFC4 are of the R.E.L. type, and the grid choke RFC3 is a homemade one adjusted to have a period (when in the transmitter) somewhere near the wavelength at which the power amplifier

is to be operated. The C1 biasing battery has a voltage of 135. Plate supply comes from the transformer T1 which in the 1MK outfit is a Thordarson 1-Kw. model giving a maximum of 2,500 volts (r.m.s.) on each side of the center-tap. Keying the a.c. amplifier is beautifully easy and key-clickless by virtue of the position of the key—in the primary of the plate transformer feeding the amplifier tubes.

Again, the tank circuit ammeter A1 (having a scale of 0 to 5 amperes and being of the thermocouple type) helps matters a lot when tuning up. Condenser C6 has a capacity of 300 μ fd. and is a National 3,000-volt type transmitting variable condenser. The antenna ammeter A2 has a scale of 0 to 5 amperes and the antenna series condenser is a National of 150- μ fd. maximum.

Coils L and L1 are home-made, although any of the inductances on the amateur market may be substituted for them. The 1MK ones are wound with 3/8-inch brass strip, flatwise, and are supported on notched hard wood strips, the notches being 3/8-inch apart. The coil forms have a diameter of four inches. L has twelve turns and L1 nine. The coil L2 is a spiral helix of quarter-inch edgewise wound strip. This particular coil came from one of the American Sales Company's war-time spark coil transmitters, and incidentally these little inductances are the berries for antenna use in any transmitter.

By reference to Figs. 2 and 3 the mechanical construction of the transmitter can be observed readily. For 1MK the framework which houses the transmitter is over-size since it is planned to build all of the 1MK sets in this one frame. The present 100-watt "self-rectified" set will be on a baseboard on top of the frame, the 40-meter c.c. set occupies the two panels shown in the photo and there is room for an additional d.c. quarter-Kw. 80-meter set, a 20-meter set and a power panel housing plate and filament transformers, keying and filament control relays and primary filament rheostats.

The framework shown in the two illustrations is made of 2 x 2 pine, six feet high, 28 inches wide and 30 inches deep. The baseboards for the various portions of the transmitters are of 1/2-inch boxwood and the panels are also of boxwood 1/4-inch thick.

The lower panel and baseboard contain the 80-meter crystal controlled oscillator. The instruments on the panel, from left to right, are: Upper meter a 0-300 milliamperere Weston meter (MA); lower meter a 0-500 volt Weston d.c. voltmeter (V) for checking the plate voltage on the 203-A, the 0-5 ampere thermocouple meter A in the tank circuit and at the right the dial on the tank condenser C2.

The upper panel and baseboard hold the power amplifier. The left hand dial on the panel is attached to the antenna series condenser C7, the upper meter in the center is the antenna ammeter A2 and below it is the tank meter A1. At the right is the dial for condenser C6 in the tank circuit.

A side view of the transmitter appears in Fig. 3. On the lower base in the foreground at the right is the voltmeter multiplier and to the left of it you can make out the plate circuit r.f. choke, the tube socket, filament by-pass condensers and General Radio crystal holder. The grid circuit choke coil is mounted on a small strip which plugs into G-R jacks also mounted on a similar strip fastened to the baseboard. The grid choke is made plug-in so that crystals having widely differing frequencies may be used.

The upper baseboard contains the two 204-As, the plate inductance L1 and the antenna inductance L2 as well as the various grid, plate and by-pass condensers. Note that plenty of space has been provided in the framework so that one can crawl in and prowl around for bugs in the outfit. The amplifier and oscillator biasing voltages come from the dry batteries shown on the respective amplifier and oscillator shelves.

Plate and filament supply wires are passed through iron screw eyes in the vertical portion of the framework, the filament wires coming down one "leg" of the framework and the plate wires down a different leg. The screw-eyes are insulated by means of friction tape wound around the ring of the eye. The filament leads are flexible number 18 lamp cord and the plate leads are Packard Junior ignition cable wires. All of the power leads for all of the sets terminate on a common bakelite terminal strip at the bottom of the photo.

We have gone over the adjustment of crystal-controlled transmitters so many times in QST it hardly seems safe to repeat any specific directions again. It is sufficient to say that caution must be used in applying high plate voltages to the crystal oscillator. Over an extended period of time even 400 volts may shatter the crystal. After the oscillator is running in the usual and well-described manner, tune the plate circuit of the amplifier to half the oscillator's wave, attaching clip M to the coil L at a point some three or four turns from the plate end of L and close the key. Then

vary condenser C6 until maximum current appears on the ammeter A1. The antenna circuit is next tuned to the wavelength of the L1-C6 circuit. Then start all over

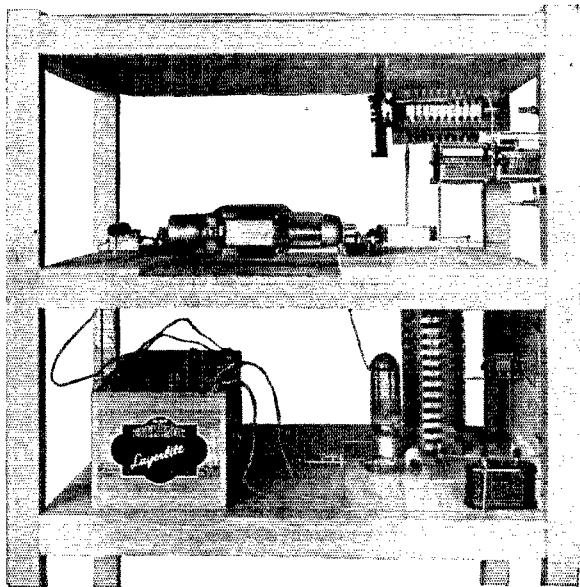

FIG. 3 A SIDE VIEW. NOTE THAT THERE IS PLENTY OF SPACE BETWEEN SHELVES

again successively monkeying with the grid biases on the amplifier and oscillator tubes and changing the position of clip M until maximum antenna current with reasonable input results.

(Continued on Page 40)

SPECIAL HIGH-POWER 5-METER TRANSMISSIONS FOR AUSTRALIA AND EUROPE

Station 2EB at 6505 167th Street, Jamaica, Long Island, New York, will send with a power of 1-kilowatt at a wavelength between 5 meters and 5.2 meters during the month of February on the following schedule. Each morning at 8 a.m. E.S.T. (U.S.A. time) for one hour, each evening at 6 p.m. E.S.T. (U.S.A. time) for one hour. These times correspond to 11 p.m. and 9 a.m. Melbourne-Sydney time, or to 1300 and 2300 G.M.T. Keying will be partly automatic "test 2EB" and partly by hand. Reports should be mailed or wired to Boyd Phelps, at the 2EB address given above or to Experimenters' Section A.R.R.L., Hartford, Connecticut.

While special arrangements have been made with Australian observers, as many European and U.S.A. reports as possible are desired. Please note all possible details.

Note especially that the wavelength will be varied slightly.

A Compact Receiver

In Which Regeneration is Controlled by a Variable Resistor

By Alpha Learned*

THE two-tube receiver set described herein has a panel only six by ten inches, the space in back of which is only seven inches deep, yet because of careful arrangement of the parts there is no loss of efficiency. Take the "C" battery, for instance. It lies flat under and very close to the frame and rotary plates of the National equicycle condenser, but it is spaced from the stationary or live plates by a distance (edge to edge) of an inch and a quarter. The two audion sockets are pretty close together too, but the sides which are nearest contain only the filament contacts, thus leaving the grid and plate leads on opposite sides, well spaced as they should be.

Fig. 1 shows the diagram of connections. The regeneration is controlled by varying a resistance in the plate circuit, which in turn causes the voltage on the plate to vary. To control regeneration by varying the plate voltage would not do at all with the old type of gas detectors such as the UV-200, audiotron, electron relay, etc., but nowadays most of us use hard tubes like the 201-A or 199 type, with which the signal intensity does not change appreciably with plate voltages varying from ten to forty-five volts. The resistance method of controlling regeneration requires a less critical

The diagram shows a separate "B" battery of twenty-two and a half volts for the detector, which of course is not essential, but it has the advantage of preventing the first twenty-two and a half section from running down before the remainder, thus ruining a whole forty-five volt block.

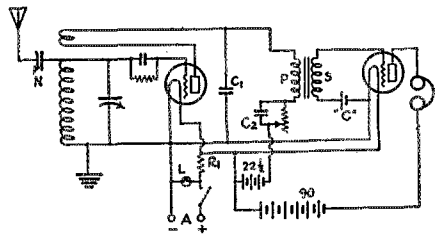
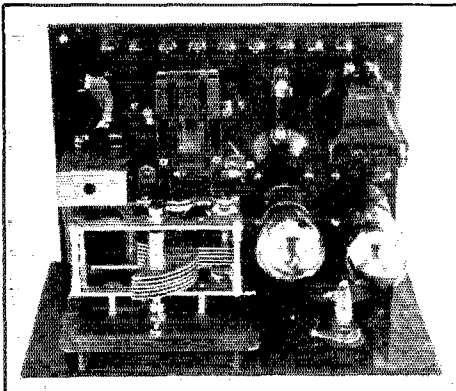

FIG. 1

Figure 2 shows the panel layout and the arrangement of the parts, for the benefit of anyone who wishes to build the receiver. The three panel controls are a four-inch Velvet Vernier dial, a two-inch rheostat dial to control the regeneration, and a "Bruno" combined filament switch and indicator. This last named device is a clever affair which consists of a small bull's-eye of red glass. Turn it to light the tubes, push it and off they go with a click. The audio transformer is a General Radio instrument with a rather high step-up ratio (six-to-one), which makes it excellent for "code" work, while it isn't half bad for broadcasting, either. Benjamin UX sockets are used with the bases removed so they can be built right into the sub-panel of the set, giving a neat appearance and resulting in a slight saving of space. A National Equicycle variable condenser of the smallest capacity obtainable (250 $\mu\text{fd.}$) was chosen and the plates removed until six rotary and five stationary plates were left, giving a maximum capacity of 160 $\mu\text{fd.}$

Two fixed condensers are used, one with a capacity of 2000 $\mu\text{fd.}$ to by-pass the r.f. around the primary of amplifying transformer, radiohm and "B" battery, and a larger one of 1 $\mu\text{fd.}$ across the variohm to absorb clicks and scratches. An easy way to make an indicating line on the panel is with a pen and white ink, but for a better job a line can be scratched with the edge of a hack saw ground to a thin edge, afterwards filling the line with white ink. Most amateurs have considerable apparatus



adjustment than the more common methods utilizing a variable condenser, but its greatest advantage is that turning the regeneration control does not change noticeably the pitch of the incoming signal. The intensity varies though, being at maximum just before oscillations cease.

*IAAU, 316 Bucklin St., Providence, R. I. Chairman Experimentation committee, Providence Radio Ass'n., Member "X" Section.

on hand, as well as their own ideas about radio parts, so there is no need of adopting the list shown below, but in such case

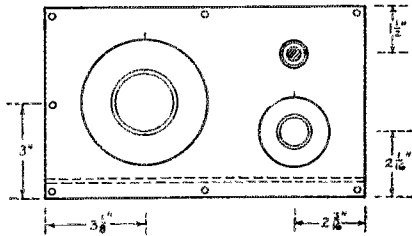

FIG 2A

it will probably be advisable to use a panel somewhat larger than six by ten.

List of Material

- National 250- μ fd Equicycle variable condenser.
- One 4" Velvet Vernier dial.
- Bruno combined filament switch and indicator.
- 2 Benjamin universal sockets.
- Centralab variomh. 50,000 ohms.
- Eveready No. 751 battery.
- Tobe 1 μ fd condenser.
- 9 Eby binding posts.
- General Radio neutralizing condenser.
- General Radio audio transformer, ratio 6-1.
- Daven filament ballast.
- Sangamo 2000- μ fd condenser.
- Sangamo 150- μ fd grid condenser.
- Rheostat dial for variomh, diameter 2 1/4".
- Sets of short-wave coils can be bought readymade or the following dimensions may be used by the home constructor:

Wave-length band	80	40	20
Sec. 3" dia. Space wound No. 18	19 turns	8 turns	3 turns
Plate coil No. 30 Closely wound at fil. end	8 turns	4 turns	2 turns

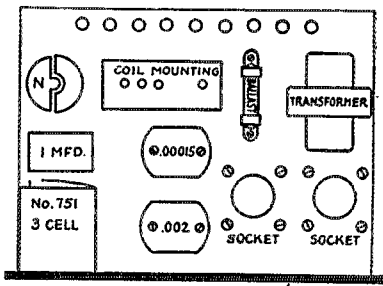
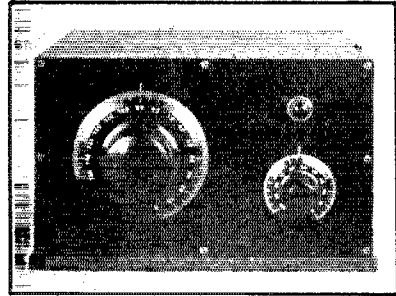

FIG 2b

A mahogany finished panel of non-warping material and oval-headed screws will make a neat looking outfit. The variable condenser end plates form a shield good enough for broadcasting wavelengths but at the higher frequencies which are en-

countered at eighty, forty, and twenty meters, slight body capacity effects will be present unless an additional shield (size 4 1/2 x 5 inches) is employed, which of course is grounded. No shield is required around



the variomh and filament switch, since they are at the low potential end of the circuit. As to results—well, if the little box doesn't sound like a beehive, I know that it's a perfectly rotten night.

Strays

Due to increased activities in the Communications Department portion of the Hq. gang it has become necessary to provide additional personnel in Handy's Department. We are pleased to announce that Lawrence A. Jones, ex2ATZ, from Brooklyn, New York, has joined the outfit as Assistant to the Communications Manager. "LJ" is a fine operator, knows his eggs and butter and is a welcomed addition to the A.R.R.L.-QST family. In addition to his duties in the office he takes regular tricks at 1MK. When you hear 1MK signing "LJ" give him a call and see for yourself what a nice op he is.

Fred Schnell has a new "9" call all of his own—9UZ. From the plans he has started, it is going to be a whizz, too.

Our attention has been brought to several cases similar to the following: 5AQV sent a QSL card to a prominent "9" station. On the card he placed the statement "R4, gud r.a.o." The "9" station returned the card with the request that 5AQV change it to read "R6 pure d.c.!" Smoly Hokes, is ham-radio deteriorating to this? We would appreciate it, OMs if you would call our attention to all such cases of poor sportsmanship.

The QST index for Vol. X (1926) is mailed to members of the A.R.R.L. with this issue of QST. If you do not receive yours please notify us immediately. Additional copies of the index will be mailed upon receipt of 4c in stamps.

A New Radio Circuit

By Robert H. Marriott, B. Sc.*

THIS article is about a new radio circuit. So many receivers during our radio years have been of the "Chinese hook up" type or have been simply a rearrangement, or have been placed in different boxes for the purpose of creating the impression that they are new that we have lost faith in the word "new".

The circuit I am about to describe (when the eulogy of the word "new" gets out of my system) is, from my point of view, entitled to be called new, because it has features which distinguish it from the circuits used in other radio receivers. The fact that I cannot remember having seen the circuit before, although I have seen a lot of circuits in my time, and that nobody else has dug up one like it where this circuit has been discussed and my understanding that the patent office has accepted it as new, leads me to believe that I can safely say that it is new—to you.

There, that is all over now. We will talk about the circuit and leave its newness up to you. The circuit was devised by Edward H. Loftin and S. Young White and is, therefore, called the Loftin-White Circuit. Mr. Loftin has specialized on radio circuits both in the Navy, where he was a Commander and was in charge of the Radio Research and Patent Section for several years, and in civil life for about three years, as consulting engineer and expert witness in radio suits involving radio circuits. Mr. White started experimenting with radio circuits about fifteen years ago and for some time past has devoted his attention to broadcast receiver circuits.

The circuit Messers Loftin and White have devised is for use, for example, between the tubes of a radio frequency amplifier. Therefore, it is natural to guess that it contains something to prevent regeneration and oscillation, or it contains something to increase the efficiency of the radio frequency amplification. The answer is that it does both.

Heretofore the attempts to prevent regeneration and oscillation have been by four general methods. One method was to bias the tube so it would not oscillate; another was to provide lesser resistance in the circuit, directly or indirectly; another was to couple very loosely; another was to use a bridge or feedback circuit that opposed the natural feedback between the grid and plate.

Loftin and White do none of these things. They put a condenser reactance in the plate circuit to shift the phase of the plate circuit so that any feed back is out of step with the grid circuit and, therefore, does not aid the grid circuit to produce regeneration or oscillation.

And they do more than that. They provide in addition to the inductive coupling, usually used in broadcast receivers, a capacity coupling, which has not before been used in such receivers. The inductive

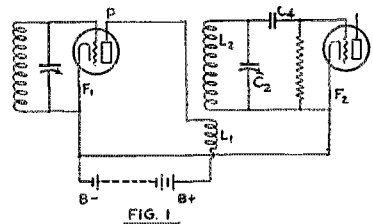

FIG. 1
AN R.F. AMPLIFIER TUBE COUPLED TO A DETECTOR IN THE USUAL WAY

coupling commonly used, does not transfer the long-wave broadcasts as well as the short-wave broadcasts, but in the Loftin-White circuit, that is corrected by the capacity coupling, which is arranged to automatically transfer the proper additional amount as the longer wave broadcasts are tuned in.

Reference to circuit diagrams should make the new features of this circuit plainer than words alone. Pictures say more without talking so much, which is a relief.

Now take the usual radio frequency amplifier circuit, Figure 1. There is a simple circuit not adorned with any preventatives. If it has enough pep in its A and B batteries to give good results for long-wave broadcasts, it will begin to blubber when you try to get a 300-meter broadcast and will howl if you try to persuade it to take shorter wavelengths. If you apply enough of some one of the well-known preventatives to stop it from howling or blubbing on wavelengths down around 200 meters, it will not do well by you on the long wavelengths and may drag in interference for spite.

There is nothing wrong with the Figure 1 circuit except that it feeds back some voltage from P to the grid of the first tube and that voltage does not agree with the tube's digestion—sort of an auto-intoxication per-

*First President of the Institute of Radio Engineers.

formance. Also, the coupling between L1 and L2 will either be too tight for short waves or too loose for long waves.

The Loftin-White circuit in Figure 2 is different. In the first place the B-battery current is fed to the tube through a coil with many turns that works something like a non-refillable bottle neck and is labeled Ch. Ch means choke which is another way of saying that radio frequency will stay away from the B-battery because Ch will choke it if it tries to go around that way. Ch will let the B-battery juice out but it will not let the radio frequency juice in.

Therefore, the radio frequency chooses the other path going through C3, L1 and C1 back to the tube filament F. C3 is what keeps the first tube from getting indigestion and blubbering or howling. C3 is of such a size that taken together with the rest of the circuit it shifts the phase of the radio frequency. With the phase shifted the voltages do not come along in the right order to cause disorder in the grid circuit. Those voltages cannot arrive at the right time to stimulate or over-stimulate the broadcast voltages in that grid circuit. With the cause of auto-intoxication removed, the receiver does not get hysterical.

L1 and L2 in Figure 2 couple the plate circuit to the detector grid circuit nearly tight enough for short waves but not nearly tight enough for long waves. However, C1 is in the coupling business too and is a normal mate for the inductive coupling L1 to L2. C1 couples almost tight enough for the long waves but not nearly tight enough for the short waves. Working together they couple tight enough for all waves. Jack Condenser Coupling cannot handle much of the short fat waves and his wife, Mrs. Inductive Coupling, cannot handle much of the long lean waves, but between them both they lick up the whole broadcast range.

One of the ways of putting this married couple of couplers through their paces, to show that one makes up for the deficiencies and idiosyncrasies of the other, is to remove the aid to digestion which is marked C3 in the diagram. With that digestive tablet C3 removed the outfit shows no prejudice at all. It howls at all wavelengths from the shortest to the longest, wherever there is a broadcast station. By decreasing its allowance of filament current or reducing the kick from the B-battery, the thing can be brought down to the blubbering state. It then gives distorted or blubbering broadcasts for all stations from the shortest to the longest waves. The pair treats all wavelengths alike and when they take C3 they handle all alike without blubbering or squealing.

This year we have heard a lot about

canned radio receivers. This year's models are strewn with bottles and cans. When they put in more radio frequency amplifiers, each with a bottle, they had to put cans around them to prevent fights. Each radio frequency amplifier couples with the others and starts an argument if its light isn't hid under a can.

Where the Loftin-White radio frequency amplifier circuit is used, it is possible to get along with less cans or other forms of shielding because C3, C1, and the coupling between L1 and L2 can be adjusted to offset undesired exchanges of force between the circuits. That is a good thing because cans sometimes introduce losses or they may be in the way and they cost something.

It is possible to do several stunts with the Loftin and White circuit. In fact, if we

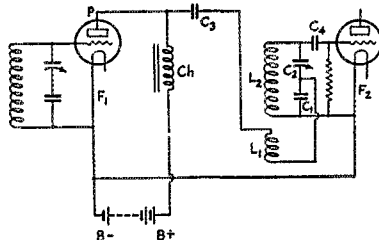

FIG. 2

THE LOFTIN-WHITE CIRCUIT

The coupling is partly magnetic and partly electric. The magnetic coupling is between the coils L1 and L2 in the usual way. The electric coupling is provided by the fact that the radio frequency plate current of the amplifier tube flows back to the filament thru the condenser C1 which is also a part of the tuned input circuit of the detector. Because C1 is fixed the voltage drop across it decreases as the wavelength goes down while the magnetic coupling between the coils increases in the usual way at the same time. The two compensate.

chose to express ourselves as a famous college professor sometimes expresses himself we might say that this circuit is "lousy" with possibilities. Loftin and White can make it do a lot of tricks. For example, reversing the connections of L1, it will play dead in the middle of the broadcast wavelength band, get good broadcasts each side of the middle, and howl "to beat the band" at both ends of the broadcast band.

If one tries to make the Loftin-White circuit from a technical description, a number of clever mistakes and some mistakes which are not so clever may be made. Indeed, one may produce quite an excess of mental fatigue, physical fatigue, holes in the wrong places, and profanity in the atmosphere, without getting the circuit to behave just right. Such results have been attained

through trying to make the circuit from technical descriptions that were, at least, worded more like orthodox technical descriptions than this description has been worded. However, it is easy enough to build if one has the right parts and something that indicates where to put those parts and how to connect them together. The wrong parts or the right parts in the wrong places produce stray couplings that prevent the parts from working the way they should.

Of course, no manufacturer sells the Loftin-White coils yet, and no one manufacturer makes all of the other parts that would be considered the most suitable for use in a receiver of this kind. One manufacturer may make the most suitable air condenser, another may excel in audio frequency transformers, another may make the binding post that we all like best, and so it goes. Therefore, it takes some time to get a kit together and after the kit is put together it must be tested and retested in laboratories or homes. Then, if it is all right, the kit must be photographed and drawings of its circulatory system must be made and it must be described and that must be followed by editing and printing. At the same time the kits must be assembled and packed up and shipped all over the United States, first to jobbers and then to dealers.

However, much of the work has been done, so we may expect to see, before many moons, the exact description of the way to build a receiver with a Loftin-White circuit in it and be able to get the parts from our radio dealers. Then we will be all set for making this circuit and for proving that it is really new and better.

The Antenna on the July Cover

THE accompanying drawings (or possibly cartoons) are supposed to unsnarl a tangle that most of the hungry question-askers in this fraternity seem to have gotten mixed up with. In our July issue we ran a story called "Feeding the Antenna" and in Fig. 7 of that story I tried to show how an ammeter is temporarily connected across the end of the two wire feed line while the first adjustment is being made. The purpose of this adjustment is to put a large current at the upper end of the feed line. Clyde Darr made this adjustment process into a cover design and showed the operator reading the temporary ammeter with a pair of field glasses. Maybe the operator was near sighted because he went half way up the pole to read the meter. On second thought it may have been necessary to send him up the pole in order to get him into the picture. It is an incidental difficulty and not the same one that our members have been getting into.

The mixup appears to be that everybody

looked at the cover and everybody read the sentence in the southwest corner of page 13 which tells about putting the meter up, but nobody went ahead and read the other equally important sentence, "The meter can then be taken out of the antenna."

The art work previously referred to is a last attempt to get this idea over. Please

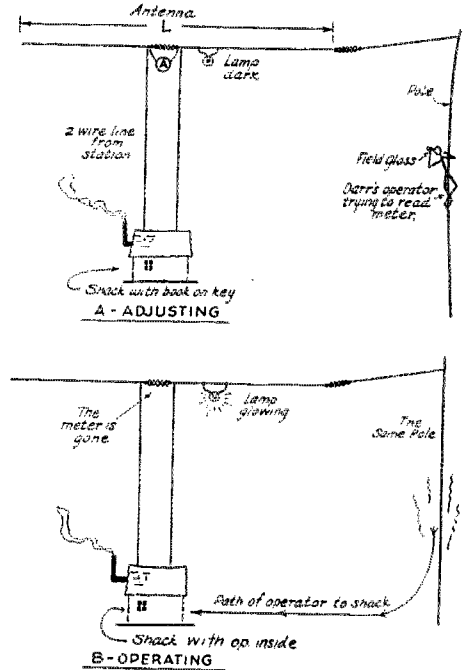

don't take it at face value in all details. The lamp has been hung up there simply to show when business picks up in the antenna; it really isn't at all desirable in an actual station because the whole neighborhood knows when you are sending. If the winking of the light happens to occur while there is a power leak or ice on the trolley wire your telephone will be very busy. Incidentally that same remark applies to all schemes using a lamp in the antenna. Someone suggested the other day that the lamp needs to be painted black except for a small window facing the station.

—R. S. K.

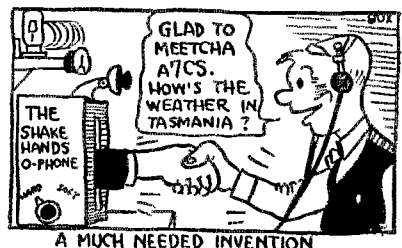

On Top of the World—nc5GO

By R. M. Foster*

WAY up North, with fifteen-hundred miles of barren wastes of mountain and ice covered stretches of ocean between it and civilization, sits one of the outposts of the white man—Ponds Inlet. At this lonely place there are but eight persons who have seen the big cities of the world; four members of the famous Royal Canadian Mounted Police, three factors of the Hudson Bay Company and one Eskimo.

Each summer the supply ship calls and delivers the mails together with the necessities of life. Until two years ago the an-

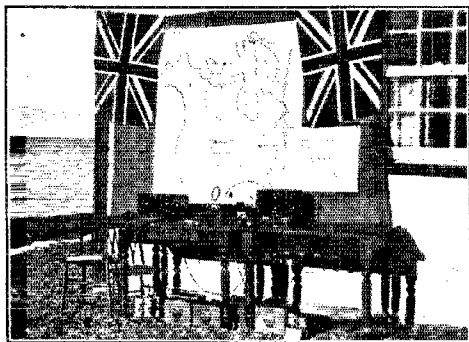

THE INSTALLATION IN PLACE

nual arrival of the ship was the only source of news, but since that time radio has had its introduction. Now a daily digest of current news is being published and the population of Ponds Inlet on Baffin Island is as well posted as the average man in the city.

north. It was agreed that he would have a short-wave amateur transmitter and receiver as soon as possible. Early in July of 1926 the S.S. *Beothic* sailed from Sydney, N. S., carrying the promised short-wave transmitter and a new short-wave receiver. The transmitter is of the portable type, as it may have to be moved from place to place. It uses two 201-As in a split Colpitts circuit somewhat similar to the set built by the Burgess Laboratories, and is provided with either telephone or telegraph connections. No power is available for the transmitter so the filaments of the transmitting tubes are lighted by a group of No. 6 dry cells. The plate supply comes from a group of oversized B batteries delivering 500 volts. All the batteries were shipped through the courtesy of the Burgess Company of Canada.

The receiver is a detector-one stage audio rig, rebuilt from an old Aeriola, Sr. with the usual WD 11 Radiotrons. It covers all waves from 18 to 90 meters.

Last winter the writer used this transmitter and receiver exclusively with excellent results, working distances up to 1,800 miles consistently. Twenty, forty and eighty meters can be used with the transmitter, and a special coil for the 52.5-meter wave for Canadian work has been included. It is on this wave that most of the work will be done in this way that most of the work will be done if possible owing to its freedom from QRM.

The following schedule has been arranged for the operation of the set just as soon as it has been installed. The writer asks the

During the winters of 1924 and 1925, special transmissions were arranged over KDKA's short-wave phone for the broadcasting of personal messages to members of the Mounted Police not only at Ponds Inlet but to all their Posts throughout the Arctic. These transmissions were a wonderful success. The idea immediately occurred to the writer that short-wave two-way telegraphic work would be ideal for these people. The only drawback to this was the lack of someone with experience to operate a transmitter.

On the 1925 voyage of the C.G.S. *Arctic* this need was filled as Constable Maurice Timbury, R.C.M.P., an ex-navy radio officer, was appointed to station at Ponds Inlet. Tim became an enthusiastic ham on the trip



CONSTABLE M. TIMBURY, R.C.M.P. AND nc5GO

coöperation of all amateurs in an attempt to open communication with nc5GO. The set should be on the air by the time these lines

(Continued on Page 40)

*c2AG, 379 Selby Ave., Westmount, Quebec, Canada.

Measuring Capacity With a Voltmeter

By Willard H. Farr*

IN these days when alternating current is being used not only for transmitting but also for B-battery supply and even A- and C-battery supply, filters of one kind and another are becoming more and more of a necessity. Practically all such filters use large capacities, i. e. in the order of several microfarads. The measurement of such capacities is rather difficult with the

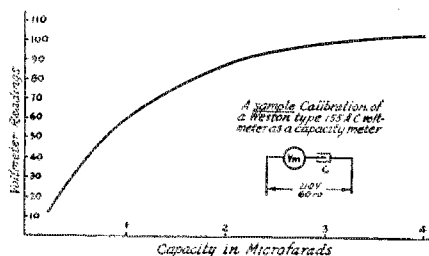

apparatus usually found in the amateur laboratory. The common method is to use a slide wire type of Wheatstone bridge, with a high frequency buzzer or some other such scheme as a source of current, and a telephone receiver as a zero indicator. That method has several snags in it for the average amateur. The slide wire type of bridge is not a very common piece of equipment, it is rather bulky to set up, it is not used often enough to pay to make it up just for the few condenser tests which would be required, and finally, it requires the use of some kind of standards every time it is used.

The writer has been using a method for several years with very good success which requires no more equipment than an ordinary a.c. voltmeter. The trick is simply to connect the condenser to be measured in series with the voltmeter across the 110-volt a.c. line. The reading of the meter will be governed by the impedance of the condenser and consequently by its capacity. The higher capacity the greater the voltage reading and vice versa. If the condenser should happen to be shorted, the voltmeter would indicate the fact by reading line voltage, and as the meter is built for that voltage no harm can result. One decided advantage of this method of capacity measurement is that you can calibrate your pet voltmeter to read capacity, and thereafter will need no standards, as would be the case if a slide wire bridge were used. Another advantage is that no setup is required, and it shouldn't take longer than thirty seconds by the watch to drag out

your meter and curve and measure up a condenser.

Fig. 1 shows a typical capacity calibration curve for a Type 155 Weston a.c. voltmeter. It will be noted that the readable range of the meter covers almost exactly the range of capacity values used in filters. It will also be noted that the curve is steeper on the lower end which means that the smaller the condenser the more accurate the reading.

Even if you do not have access to any standards of capacity, the calibration of a meter should present no serious difficulty. Procure three or four one- μ f. condensers which you can depend on to be reasonably close to their rated capacity. The agreement between the supposed 1-microfarad condensers can be checked fast enough. If they do not give the same reading they are not alike. The leakage ordinarily found in condensers is not enough to change the results greatly. Connecting these in parallel will give you points on the curve at 1, 2, 3 and 4- μ f. while connecting them in a series of 2, 3, or 4 will give you values of .5, .33 and .25 respectively. This is a sufficient number of points to give a very satisfactory curve, the accuracy of which will be as good as the average of the condensers you used in the calibrating process. All intermediate values may then be read directly from the curve.

ON TOP OF THE WORLD—nc5GO

(Continued from Page 39)

are in print. The schedule is: 5GO will be in operation daily on 20, 40 and 80 meters from 9:00 p. m. (E.S.T.) until midnight except on Wednesdays and Saturdays when transmission will be on the 52.5-meter Canadian wave from 11:30 p. m. until 1 a. m. the following morning. Canadian amateurs especially are asked to listen for signals on this wave. Just as soon as any amateur works 5GO the writer would appreciate it greatly if he be notified. Any QSL cards for 5GO can be forwarded through the writer also.

A D. C.-A. C. CRYSTAL-CONTROLLED TRANSMITTER

(Continued from Page 23)

A transmitter such as this one is comparatively simple to build, easy to get going, does not require many high-priced parts and gives a note that is indeed a pleasure to copy. Again, remember that the same general construction can be applied to the 50-watt amplifier with the 7½-watt oscillator, or the 7½-watt amplifier with a receiving tube oscillator.

*AULT, 6024 Dakin St., Chicago, Illinois

An Airplane Transmitter

By G. H. Browning* and R. S. Briggs†

IT WAS thought that it might be interesting to present the design of a short-wave phone and c.w. transmitter which was constructed for use in an airplane but is well suited for general amateur needs and is in fact being used today in just that way. This transmitter employs UX-201-A tubes throughout. Most of the apparatus necessary for its construction is to be found around the fan's laboratory, or is carried in stock by the local dealer. The set consists of one modulator tube, one oscillator, and a neutralized power amplifier made up of two tubes in parallel. The modulator can of course be omitted.

Since this set was intended for use in an airplane, certain special requirements of design were necessary. First, the frequency must remain constant and not be affected by vibration. Second, the set had

The plate supply consisted of about 90 volts of "B" battery. A small 6-volt storage battery was used to light the filaments while

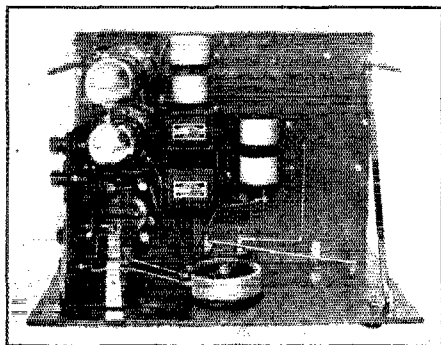

UNDER SIDE OF SHELF, SHOWING R.F. CHOKES, MODULATION CHOKES, MODULATION TRANSFORMER AND INVERTED TUBES

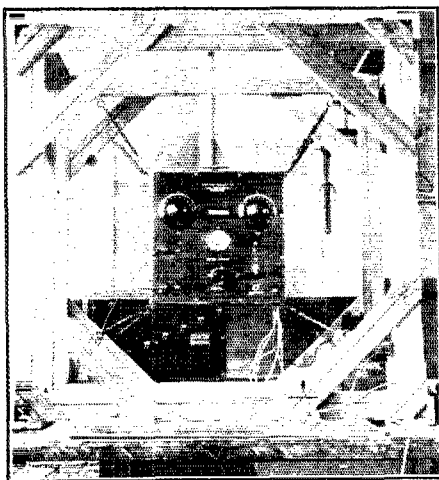

THE SET SPRING-SUSPENDED FOR AIRPLANE USE

to be light, portable and compact. Third, a fair amount of efficiency was required with a reliable daylight phone range of at least 2 miles. Wavelengths around 100 meters seemed to be the best suited for airplane operation, so the transmitter was built to cover a band of from 70 to 110 meters. An antenna system with a natural wavelength of 70 meters can easily be installed on the wings of an airplane. The antenna coupling inductance will load up the circuit to some extent.

9-volt and 3-volt dry batteries were used as "C" and microphone battery respectively.

The photographs show the general layout of the apparatus. The antenna current meter is mounted on the panel and is a 0-0.5 amp. thermocouple type. The right hand dial controls the wavelength of the master oscillator and the left hand dial, the power amplifier. No adjustment of antenna tuning is used since the antenna system is constructed to operate on a fixed wavelength. It should be a single wire of about 35 feet, including lead-in. An external series condenser can be used if the set is to operate over a band of wavelengths. A shelf behind the panel is used to support most of the parts. Looking at the back of the set, the power amplifier tubes are mounted upright and the master oscillator and modulator tubes are mounted upside down underneath the shelf. All tube sockets have sponge rubber mountings. The left hand coil is the master oscillator inductance, and the right hand coil is the amplifier and the antenna inductance. A battery terminal panel is placed at the extreme left, under the shelf. The audio and radio frequency chokes are mounted under the shelf to the right of the master oscillator tube. With this layout, short direct connections are possible with minimum interaction between circuits. The panel is 14" square and $\frac{1}{4}$ " thick. The shelf is 10 x 12 $\frac{1}{2}$ " and $\frac{3}{16}$ " thick. The panel is screwed onto a hinged frame so that it can be swung out of the

*Consulting and Research Engineer, †1BVL, 398 Ashmount St., Dorchester, Mass.

cabinet for accessibility. When used in an airplane cockpit the cabinet is supported by eight springs—one for each corner as shown in one of the photos.

Four 201-A tubes are employed in a master oscillator—power amplifier circuit using Heising modulation for phone. One modulator, one master oscillator, and two

to be ideal, since it is not sensitive to outside noises and can be worn under a coat collar, thus taking up very little room. This microphone is merely a carbon button mounted inside a small hard rubber case. It is held up tight against the throat for the best results. Of course, any suitable microphone can be used if the set is to be

operated on the ground. Two National impedance chokes are connected in series with the plate supply lead of the master oscillator, and modulator tubes. They serve both as an inductance to provide the required constant current of the Heising modulation system and as a resistance to cut down the plate voltage. The General Radio modulation transformer has a 1-megohm resistance across its secondary when a microphone battery of 3 volts is used. The master oscillator uses a tuned plate circuit with a fixed grid tickler coil. L_1 , L_2 and L_3 are space wound on 3" hard rubber tubes. L_1 and L_2 are wound on the same tube and are $\frac{1}{4}$ " apart. The amplifier tubes are connected in parallel, and are neutralized by the condenser C_2 and two turns of inductance L_2 . The neutralization is not very critical. It is very important to place L_2 and L_3 at right angles to each other, and at least 8" apart, as shown in the photo; otherwise it may be

impossible to prevent the amplifiers from self-oscillation. Care must also be taken to prevent coupling between the radio frequency chokes and L_2 and L_3 . The 8-turn grid coil is wound on the same tube as L_2 and $\frac{1}{4}$ " away from the filament side of L_2 . The grid coil is wound jumble fashion in a $\frac{1}{4}$ " groove. A small 6-volt pilot lamp is connected across the filaments which are controlled by a toggle switch mounted on the panel.

In order to get the set into operation, C_1 and C_2 are adjusted until the antenna current is maximum, then C_1 is readjusted slightly so that the plate current is cut down without any decrease in antenna current. In order to be sure that the set is working properly and that the amplifier is not oscillating, take out the oscillator tube. The antenna current should fall to zero. The phone will not work unless the amplifier is operating properly. For c.w., the key is placed in the negative "C" battery lead. The modulator tube may be removed if desired. It is advisable to use a variable neutralizing condenser to facilitate neutralizing. Any variable condenser with a maximum capacity of 100- μ fd. will be ok. In order to neutralize the set, turn on all filaments, except those of

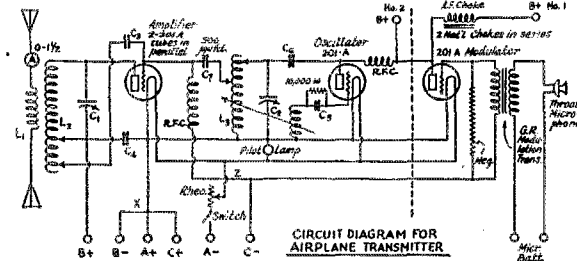

THE CIRCUIT

L_1 , 15 turns No. 16 wire wound on $3\frac{1}{4}$ " tube with turns spaced by somewhat more than the diameter of the wire. (Antenna coil)

L_2 , 17 turns of same construction as L_1 , and wound on other end of same tube. Space between windings not critical. Photo shows nearly enough. (Primary coil)

L_3 , 12 turns similar to L_1 . (Oscillator coil)

C_1 & C_2 , National Transmitting condensers, 150- μ fd, 3000-volt, 50- μ fd micadon.

C_3 , C_4 , 2000- μ fd micadons.

C_5 , 500- μ fd micadon.

RFC 100 turns No. 28 DCC on $1\frac{1}{2}$ " tube.

A. F. Choke Two National impedance-coupling chokes in series.

For c.w. work the apparatus to the right of the dashed line is omitted and the B plus connection shifted from B plus post No. 1 to B plus post No. 2. The key may be cut in at X or Z.

power amplifier tubes are used. The oscillator is modulated before its output is

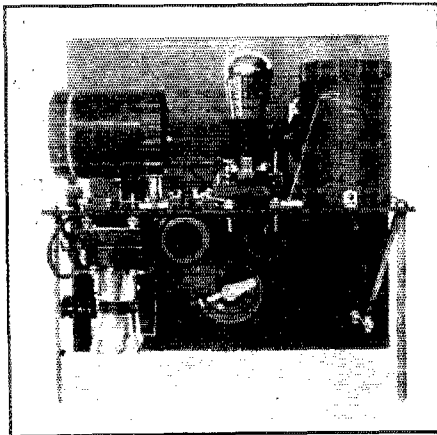

REAR VIEW OF THE SET SHOWING RELATIVE POSITION OF TUNED-CIRCUIT HELICES AND R.F. CHOKES. THE CHOKES CAN BE LOCATED MORE ACCURATELY BY REFERENCE TO THE BOTTOM VIEW

amplified. After considerable experimenting, a special throat microphone was found

(Continued on Page 50)

Experimenters' Section Report

THE Experimenters' Section has since about the first of this year been in new hands, insofar as the correspondence and outlines are concerned. Assistant Technical Editor John M. Clayton having left *QST* in favor of the Institute of Radio Engineers his desk has been taken over by our new Assistant Technical Editor, H. P. Westman who formerly handled the X-

acknowledgments are urgently requested. It is exceedingly discouraging to do a precision job for months without definite information as to results.

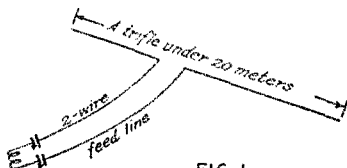

FIG. 1
NOTE: To work at 20 and 40 use shorter top

section matters above referred to. The information desk and the X-section correspondent (as well as outlines) are now under the care of Ross A. Hull, Secretary of the Wireless Institute of Australia, who has joined our staff. This does not change the other contacts of the Section. The files are handled by Lawrence Flebeau as before and the Section remains an offshoot of the Technical desk. Enrollment is informal, as before.

OWLS-SF STATION RECEIVES X CALL

The OWLS Standard Frequency station at Anoka, Minnesota has at last been assigned an "X" call. On its future schedules

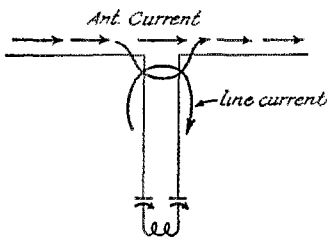

FIG. 2
As top and 2-wire feeder - 40 meters

the station will not sign 9WI but 9XL. The station is a portion of the "Gold Medal Station" and is operated by Hugh S. McCartney, Chief Operator of WCCO. Acknowledgments of the transmissions of 9XL should be sent to the Experimenters' Section, A.R.R.L., Hartford, Conn. Such

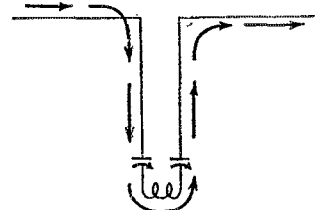

FIG. 3
As folded antenna - 80 meters

1XM is now operated under a cooperative scheme which includes the M.I.T. radio society, the communications department of the same school and Mr. James K. Clapp of the M.I.T. faculty in particular. Acknowledgments as to 1XM's work are solicited. They also should be addressed to the Section at Hartford. This keeps all hands informed as the letters will be forwarded.

REGARDING REPORTS

Every once in a while we find by accident that some member of this section has accumulated some excellent material and is

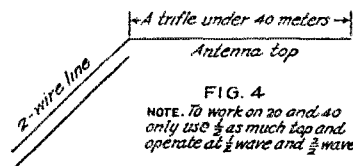

FIG. 4
NOTE: To work on 20 and 40 only use $\frac{3}{4}$ as much top and operate at $\frac{1}{2}$ wave and $\frac{3}{4}$ wave

waiting for us to drag him out of his hole and take it away from him. That is all right—except that we can't be going after all of you all the time. Please don't wait until you have a *QST* article ready, let us know what is going on meanwhile. Very often the material is dead if held until it has become bulky enough for an article. This may be because someone else has done the same thing, or it may be because the radio art has taken one of its sudden turns.

Please don't be too modest—and be a little more communicative.

CONCERNING ANTENNAS FOR SEVERAL WAVE-BANDS

The note regarding antennas good for several bands of wavelengths brought fruit—mainly quite alike. The popular suggestion is that we arrange an antenna as

shown in Fig. 1, making the antenna top of such length that it will have a length in meters equal to $\frac{1}{2}$ of the wavelength which is to be used in the 40-meter band. When working in this band the antenna current

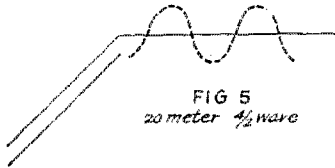

then flows as suggested in Fig. 2 with the two-wire line acting as a feeder only. When working in the 80-meter band the current goes as suggested in Fig. 3, the line then becoming the central part of the antenna system itself. It is hoped that later we can give some details on this system as used at 3CAB, Washington, D. C.

Another suggestion is to arrange the antenna as shown in Fig. 4, feeding from one

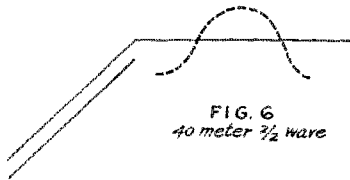

end with a 2-wire line. The voltage distributions for the 20-, 40- and 80-meter bands are then as shown in Fig. 5 and Fig. 6.

Naturally any of these ideas can be applied to other combinations of wavebands, also the wave in each band is somewhat flexible. Next month we hope to combine

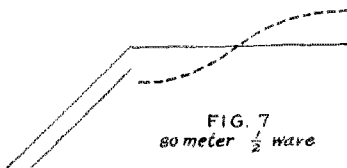

the material received with some generated here to produce a short QST article on band-to-band wavechangers. Meanwhile comment has been solicited from the membership of this section.

A FIELD STRENGTH METER

Quoting from a letter of A. N. Owens of Los Angeles. In Fig. 8 is "a circuit for measuring field strength which I have used for the eclipse tests (Jan. 1925) and for checking methods of coupling.

"The principle is the same as used by Dr.

Austin and set forth in Bustan circular 74. The only difference is in the feedback control and in an arrangement such that the plate current does not affect the galvanometer directly as in Dr. Austin's method.

"The galvanometer should have a resistance of one- or two-thousand ohms and should be of the scale-and-pointer type. In operation be sure that the tube is not oscillating or there will be a false indication. The most sensitive point is, of course, just under oscillation. Increase feedback until

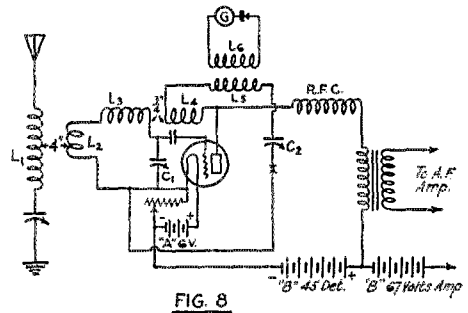

THE FIELD-STRENGTH INDICATOR

The dimensions are for the 200 to 600-meter band and must be modified suitably for shorter or longer waves.

- L1 Usual antenna coupler primary to suit the user.
 - L2 Usual antenna coupler secondary.
 - L3 Secondary loading coil—may be consolidated with L2.
 - L4 Tickler.
 - L5 110 turns No. 22 D. C. C. on 2" tube, primary of crystal transformer.
 - L6 Just like L5 and wound over it.
 - R. F. C. choke coil suited to wavelength used.
- In the set used all couplings were fixed
G Galvanometer, Queens-gray E 3105 test set galvanometer.

The detector was of the usual galena type. C1 and C2—Tuning and regeneration-control condensers suited to wavelength worked on.

Note—For shorter wavelengths the crystal transformer windings would need to have fewer turns. This transformer may also be cut in at X which removes some capacity effects, besides making it more convenient to arrange a cutout. The crystal and galvanometer may also be connected to the output of the transformer marked "to a.f. amp." whereupon they will operate on the a.f. component.

the galv. starts to indicate and then decrease feedback until the galv. just returns to 0, then tune the primary."

Mr. Owens has used this device to study the L/C ratio problem in tuners and also the merits of tuned versus untuned antennas for receiving. His conclusion is that the tuned antenna and high L/C ratio are very much worth while in so far as non-oscillating reception between 200 and 600 meters is concerned. The device has also been used to observe the fading of KDKA at Richmond, Indiana.

(Continued on Page 50)

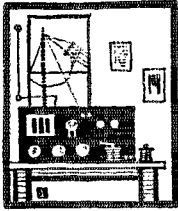

Amateur Radio Stations

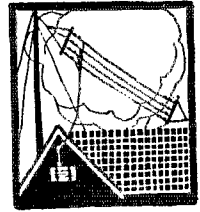

1 BIG Wins Traffic Trophy!

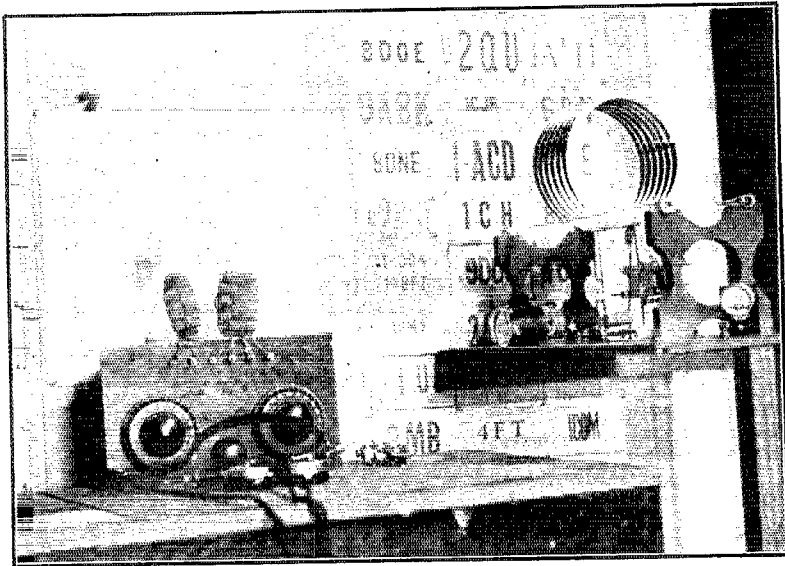

FOR being the League's leading Brass-Pounder for three consecutive months since February, 1925, when the Traffic Trophy contest was inaugurated, Frederick Best of 1BIG at Augusta, Maine, has just been awarded the beautiful Traffic Trophy, donated by a very good friend of the League. The Trophy is a plaque of sterling silver, mounted on a polished mahogany background. The silver portion is approximately twelve by fourteen inches in size.

In the space below the inscription there will be engraved a record of the messages handled each month. The total number of messages 1BIG handled in these three months was well over 2,500! The messages here at A.R.R.L. Headquarters for checking purposes stack up in a pile over ten and a half inches high! And during the last month

alone, 1BIG handled some 1,200 of them.

THE STATION

To the great surprise of a lot of us, 1BIG is using a lone 210 tube in the transmitter! In fact the station is so very simple we had an awful time getting Best to let us run the dope on it. The transmitter is remotely controlled, being placed in the attic, and started and keyed from the living room three floors down. The set uses a Hartley driver. The inductance is seven turns of old R.C.A. helix spaced with maple "beads" five-eighths inch long, and strung on linen thread. Both the beads and the thread were boiled in paraffin. The helix is mounted on two ten-cent glass towel bars which are supported by two wooden end pieces, also boiled in paraffin. The end pieces keep the field of the coil well

away from all other parts of the transmitter. The tube is a 210, 7½-wattter supplied with raw a.c. The input has never exceeded 15 watts.

The grid and plate condensers are fixed mica receiving condensers; the tuning condenser is a Cardwell 250-μfd. receiving type with half of the plates removed. The plate choke is a 100-turn coil wound on a

feet from the end. Eighteen-inch towel bars are used as insulation in the whole antenna system.

A separate antenna is used for receiving and this with the remotely-controlled transmitter allows excellent break-in which is a very useful addition to any traffic handling station. The receiver is a copy of the one constructed by Reinartz for use on the *Bow-doin* during the last trip to Etah. A three-plate National condenser, cut to approximate straight frequency line form, with a twenty-one turn coil for the forty-meter band, and a fifty-four turn coil for the eighty-meter band, spaces all stations in fine style. Each coil with the small condenser just covers each amateur band, thus making an ideal receiver for traffic work.

1BIG was constructed primarily for traffic work up to a distance of five-hundred miles, on schedule. A regular mid-summer schedule has been maintained with 4XE at Winter Park, Florida, three nights a week over an extended period with 100 per-cent contact. Sigs. of 1BIG have been reported from England, Porto Rico, Brazil and California.

Best got the short-wave amateur bug while a radio operator in the Navy. In Constantinople on the U.S.S. *Hopkins* he first saw *QST*, that particular copy belonging to the radio officer on the ship. In 1923, when he had finished his hitch in the Navy, 1BIG came on the air almost immediately. Best is the A.R.R.L. Section Communications Manager for the Maine Section, a *real* operator and an ardent A.R.R.L. booster. He is a member of the Naval Reserve and is very active in the Communication Division activities of the first Naval District.

Our best congrats, OM, on winning this splendid trophy. Were it not for the fact that 1BIG does not seem to need it, we would say "More Power to You".

Stays 'T

We wish we had the time to personally QSL all of the very nice Christmas cards and greetings which the gang has showered upon the Hdq. bunch. Needless to say these expressions of good cheer and good fellowship are greatly appreciated and are reciprocated many times over, OMs.

One of our friends in New York writes us that the New York Library copy of the August '23 number of *QST* has the Dellenbaugh filter article carefully removed from the mag. These back issues of *QST* are in demand!

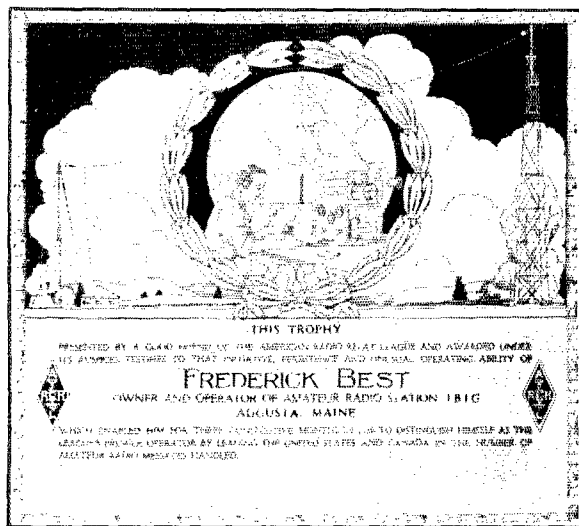

mayonnaise dressing bottle. All of the leads with the exception of the filament lead to the inductance are soldered in place. This latter lead is terminated on a clip by means of which more grid or plate turns can be cut in readily. With the Cardwell condenser the driver can be tuned to a maximum of

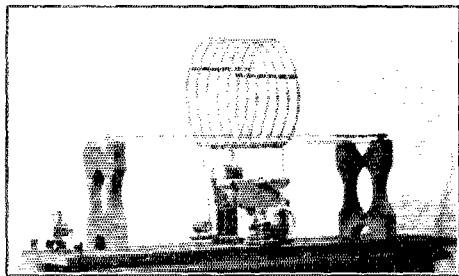

43 meters. The transmitter is mounted on a board 12 x 22 inches. The transmitter also operates on the 80-meter band.

The transmitting antenna is a voltage fed device, the antenna proper being fifty-eight feet long. It is a single number 12 enamel wire. The feeder wire is a piece of number 22 enamel wire forty feet long, and is attached to the antenna at a point about fifteen

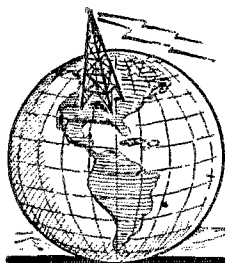

I.A.R.U. NEWS

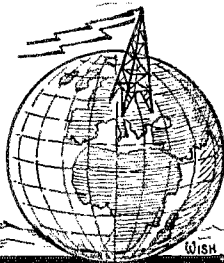

On page 54 of the January 1927 issue, in the I.A.R.U. News Department, the list of newly approved International Amateur Intermediates were run. These became effective at 0000 (GMT) on February 1st, 1927. These intermediates should be used in all amateur work. If you do not have the list which appeared in the above-mentioned QST write us, enclosing four cents in stamps, and we will shoot you one printed on cardboard so it can be hung on the wall of the shack. Henceforth all contacts, all lists of calls heard and all other references to amateur calls in which the intermediate appears will be shown with the new intermediates. And do us a favor, OM. If you establish contact with a new station in a new country and the operator is using the wrong intermediate, drop us a line (a card will do) so that we can not only record the contact in QST but can also drop the new man a set of the new intermediates. Tnx, vy.

NEW ZEALAND

THE following bulletin of news came in via radio through 9XI: "Since October twenty-eighth, great work has been done between oz2AC and ef8JN on fifteen and twenty meters. Contact has been held over a period of eight and one-half hours from 0630 to 1500 GMT, establishing a record. New Zealand 2AC keeps a schedule with both ef8JN and af1B. When the annual banquet of the Radio Society of France was held on October 30th, af1B transmitted a speech of 350 words in French via oz2AC at 1000 GMT on October twenty-eighth. oz2AC then established contact on twenty meters with ef8JN at 11:30 the same night and relayed the speech which was read at the banquet. This traffic was copied single by oz2AC from af1B with a repeat of only four words. On November eleventh oz2AC connected ef8JN and af1B for thirty minutes' communication, the distance being approximately 15,000 miles.

Both stations were QRK at oz2AC. af1B was also QRK at ef8JN on fifteen and also twelve meters. oz2AC and af1B have both worked ef8JN on fifteen meters. We believe we can hold contact between ef8JN and oz2AC for twelve hours on 20 meters as the signals were still good at 1500 GMT. Tests are to be carried out on shorter waves in the near future."—oz2AC.

MADAGASCAR

Early in December nu8KS of Rochester, N. Y., raised a new station, and one we believe coming from a new country, radioly speaking. He hooked a station signing

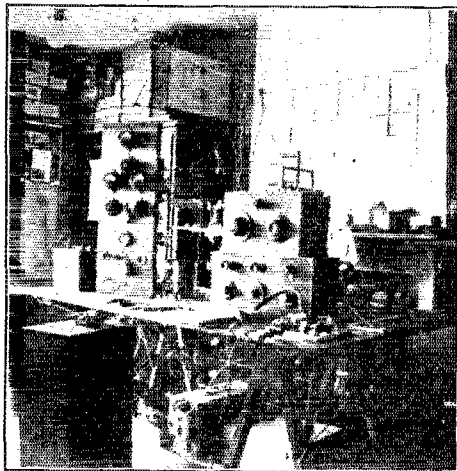

ef1B OF ANTWERP, BELGIUM

what at first appeared to be 6FR but later on turned out to be FR6, using an intermediate cf of (which would now be fb). The QRA given was La Junta, Madagascar. Further particulars are lacking. If you know the op's name and street address, QRH, etc., by all means let's have it.

AUSTRIA

nu2CRB reports having worked a new Austrian station—5TH (new intermediate is ea) located at Polytechnicum, Vienna, Austria. Any further dope?

BELGIUM

We are showing herewith a photo of the well-known station ebB1 owned and operated by Louis Era of Antwerp. The transmitter, at the left of the illustration, uses a single Telefunken 50-watt tube. Plate supply comes from a 240-watt 500- to 900-cycle Telefunken generator driven by a 6,000 r.p.m. motor operating from the 110-volt a.c. lighting mains. The filament of the tube is heated from a 100-amp. hour storage battery. A plate transformer with taps giving voltages from 400 to 6,000 is used with the generator. The transmitter operates in a loosely-coupled Hartley circuit. Two receivers (at the right of the photo) are used. The lower one is built along the plan of a Grebe CR-18 and covers a wavelength range of from 15 to 700 meters. The upper receiver is also a plug-in affair with one stage of radio frequency amplification ahead of the detector. Its range is 200 to 20,000 meters.

CHILE

sc2LD has been in operation over four years. The present layout appears in the photo. The transmitter uses three UX-210 tubes operating in a shunt-feed Hartley circuit. Plate supply comes direct from the three-wire 440-volt d.c. mains. The tube

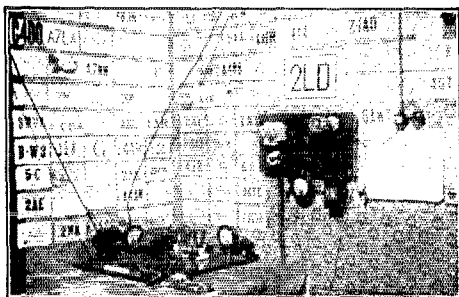

THE WELL-KNOWN sc2LD-2AG AT SANTIAGO

filaments are heated from a 120-ampere hour storage battery which is connected to the 440-volt line (through a resistance) every time the key is operated. The receiver is a modified "Perry O. Briggs" type, the modifications being in line with suggestions by Major Raven-Hart of ex9TC. It employs a 201-A detector and one stage of 201-A audio frequency amplification. The antenna system consists of a two-wire V-shaped antenna 24 feet long and 30 feet above the metal roof of the house. The single-wire lead-in is 39 feet long. Although the antenna lead-in is situated in a particularly poor position, passing within a few inches of the metal gutter pipe and for a distance of 24 feet within one foot of the

metal roof, 2LD has been reaching out in splendid fashion, his signals having covered almost every part of the globe.

WEST INDIES

nu4JS of Charlotte, N. C., recently worked station sm1P (intermediate now is nl) who is P. J. Frigerio of St. Martin Island, West Indies. St. Martin is one of the

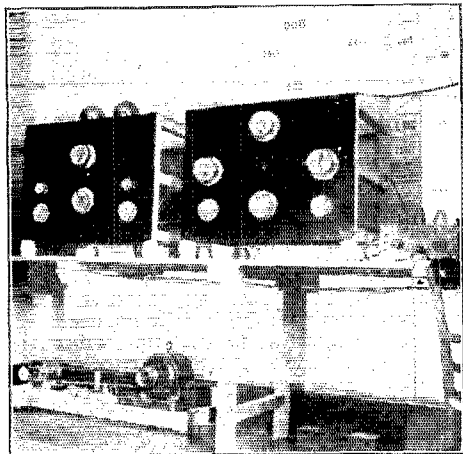

cf8CL NEAR PARIS

Leeward Isles of the larger Lesser Antilles group directly east of Cuba and north of South America.

ECUADOR

A great number of fellows have been working gh1FG (new intermediate se) whose complete and correct address (from nu3PY) is Fava Giovanni, Maggiore di Artigliera, Missione Militare Italiana, Quito, Ecuador.

BRITISH ISLES

bi2ZZ, giving his QRA as South Orkney Islands and nu9DUD were recently QSO. The intermediate bi in this case should be eg as the Orkney Islands are so very little north of the mainland of the British Isles its hard to tell which is which. We would appreciate any further information on eg2ZZ.

"ANK"

Many months ago in QST we recorded the work between a number of U. S. amateurs and a station signing ANK and giving his QRA as British Savoy Geographic Expedition in the Sahara Desert, 1,500 miles South of Tunis. All of the QSOs with ANK were on a single night and he was never heard from or of until very recently two other American hams report working ANK, with the same QRA as

previously noted. We have reason to doubt the authenticity of the call, the existence of such an expedition and the QRA. We would appreciate it, fellows, if you keep a watch for ANK and advise us promptly if you work him.

FRANCE

The photo reproduced in this column is one of station ef8CL located at the Pavillon de Moignon, about 50 miles northwest of Paris. The transmitter (the right hand panel in the photo) uses two 250 S.I.F. tubes operating in a symmetrical Mesny circuit. The other panel houses the rectifier which consists of two tubes working in a full-wave circuit, and supplied with 5,000 volts from the 110-volt lighting mains. An auxiliary generator giving 1500 volts and driven by a half horse motor is seen beneath the operating table. This m.g. set is used with a small 100-watt transmitter which does not appear in the photo. ef8CL has had two-way communication with 56 U.S. amateurs, 3 Canadians, 1 Australian, and quite recently was QSO foA6N. The owner of the station is M. Lebandy and the operator A. M. de Vanelot. QSL cards should be sent to the latter care 19 rue de Marignan, Paris, France.

U. S. RADIO DISTRICTS

At the suggestion of several of our foreign friends, we are reproducing herewith a map of the United States with the various U. S. Radio Inspection districts outlined in heavy lines. The large figure refers to the number of each district. This map is reproduced with the hope that the fellows in other countries may get some idea of the approximate location of the nu-station they are working. It must be noted that the 2nd, 3rd and 8th districts are so divided that they do not have their boundaries confined to the boundary lines of the states they cover. The same applies to the ninth district in which case the upper portion of the state of Michigan is in the 9th district and the lower part in the 8th.

SOUTH AFRICA

From Raymond Coombs, Hon. Organizing Secretary of the South African Radio Relay League comes the following which is repeated verbatim: "During the coming season it is expected and hoped that quite a large number of American visitors will be traveling to South Africa. Among these visitors there will sure be some who are interested in ham work. I should like to extend to them a very hearty invitation to meet as many members of the S. A. R. R. L. as possible during their journey through the Union and Rhodesia. Will all readers of QST who contemplate visiting South Africa kindly communicate with J. S. Streeter, foA4Z, "Wood Green", Liesbeek Road Rosebank,

Cape Town, or H. W. Heywood, foA3E, Berea Road, Durban. A visit to South Africa will not be complete unless you come up to Johannesburg where we produce the gold. The League Headquarters will be pleased to hear from visiting OMs and YLs and will see that they meet all the gang in this city who you have heard and worked during the past twelve months. Information regarding the League or other matters will be gladly given if you drop a line to Hon. Org. Secretary, Box 7007, Johannesburg, South Africa."

From R. Oxenham of Cape Town we have received the dope which follows: "Conditions have improved a good deal and many

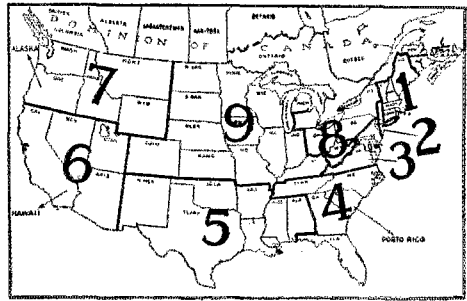

THE U. S. RADIO DISTRICTS

QSO's have been made between nu's and fo's. The 6th and 7th districts get a lot of attention in the afternoons here, the signals apparently coming from the East—the longest way around. foA5Z and foA3C are to be commended highly for having established communication with the nu's as they use very small power. foA5Z uses an input between 20 and 30 watts and has a pure d.c. note which is due to storage battery plate supply. South American stations are now booming in again and many QSO's are being made. Some of the best sb stations are 1B1, 2AB, 1AO and 1AW. These four can be heard nearly every night and in addition a great number of the low-power Brazilian stations are being heard and worked here now. sc2AR is also coming through very well. Australian and New Zealand stations are entirely absent. Of the Argentinians, CB8, BA1, AF1, DH5 and a lot of others are received in fine shape here. If the New Zealanders listen for us at 0600 to 0700 GMT Sunday morning (South African day) they will no doubt make contacts with us. Many sb's are heard calling oa and oz at that time. The Philippines are often heard although QSO with these stations is spotty. French stations with their a.c. notes are often audible; likewise a few eg's but conditions North are none too good at present. The

U. S. stations are coming through nightly at about 2130 GMT onward. Many more QSO's will be made during the nu winter".

MADEIRA ISLANDS

On December 5th and again on the 8th, nu8WT connected with a station we believe to be located in the Madeira Islands. The call was BBT, the QRH 35 meters and the QRA given as Vincenti Camba, De Maria de Haro, 54 Santos Madieros, Venecio. We may have the telephone number included in the QRA, but don't believe so. BBT does not speak English and not enough of his language was given in the contact with 8WT to positively fix him as a Madeira Islander. Any further dope will be appreciated. If he is in the Madeira Islands the intermediate should be op.

ATTENTION, DXERS

In order to get the idea of the new intermediates over to all of the gang, we would appreciate it if you would tell every new man you work, who is using an intermediate differing from the one now officially approved by the I.A.R.U. for his country, that he is using the wrong one, and tell him what he should be using. Then drop us a card or letter and we'll see that he gets a list of all of the new intermediates. You'll find a complete list of the new intermediates on page 54 of the January 1927 issue of QST.

ICELAND

nu1AXA and RQP were QSO on November 24th. RQP gave his QRA as L. Kohler, Reykevjk, Iceland. The QRH was about 32.2 meters. Further dope needed.

LEEWARD ISLANDS

Another new one, BIG1 and nu1ABZ were QSO early in December. BIG1 gave his QRA as in the Leeward Islands, in the straits just north of South America, on the east coast. The intermediate should be nl as this is one of the group of islands in the Lesser Antilles.

AN AIRPLANE TRANSMITTER

(Continued from Page 42)

the power amplifier tubes. Press the key and swing condenser C₁ from maximum to minimum noting any variation in plate current. Adjust the neutralizing condenser until a minimum variation of plate current is noticed.

This airplane transmitter has been in operation for a number of months, using an 84-meter wavelength, at the National Company laboratory in Cambridge, Mass. The

call is 1AXL. Successful daylight phone transmission has been done up to 22 miles. A range of 200 miles is easily had in daylight with c.w. transmission. The frequency is very steady, so that the signal can easily

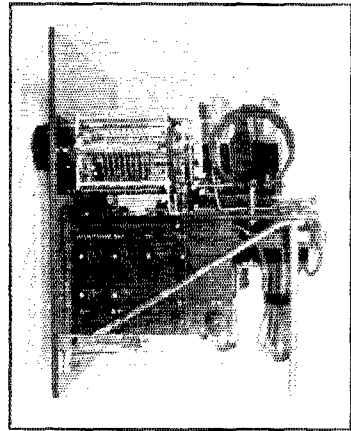

LEFT SIDE OF SET WHEN REMOVED FROM CABINET

be tuned in. This type of transmitter should be very useful and effective where a portable set is wanted, with no power mains available.

EXPERIMENTERS' SECTION

(Continued from Page 44)

HIGH-POWER 5-METER TRANSMISSION

Elsewhere in this issue there is an announcement of the continuation of the 1-kilowatt 5-meter tests from 2EB at Jamaica, Long Island. Please continue to observe on these tests, even though nothing has been heard by you to date. Experience indicates that weather is of great importance at this wavelength.

This is the same series of tests which began January 15th of this year. The wavelength will according to present plans be kept between 5 and 5.2 meters.

Strays

5RG was recently QSO an sb station from 5AQ. At the end of an enjoyable conversation via the "Q" signals, 5RG attempted to be Spanish and told the sb fellow "Buenas Stadis," which is very bum Spanish for "GN." Imagine his surprise when the bz fellow came back in English and said, "Sorry, OM, I don't speak Spanish!"

Calls Heard



Effective with this issue of QST, all Calls Heard will appear with the new international intermediates before the calls. The fellows have been getting increasingly sloppy in the manner in which they have been preparing Calls Heard of late. The sample list of Calls appearing below MUST be followed in the future if you want us to use yours. Note that the intermediates are not used before the "nu" calls, in the list proper.

nu-7ZAB, H. J. Smith,
33 South Street,
South Falls, Oregon.

1aao 2abc 3ab 4by 5zai 6hm 7it 8gz 9zt
cb-4za na-7yi np-2jm se-2ld sr-1al sv-
aa7 fn-g6a fo-a4z oh-6buc oz-4ac.

The letters can be either capitals or small ones; the dash must appear between the intermediate and the call; no punctuation should be placed between the calls; the calls MUST be printed legibly and if typewritten MUST be double-spaced. If the intermediate is printed in small letters, the call must be likewise and vice-versa.

1A0Q, 51 Washington Street, Concord, N. H.

3alq 2bny 3cdk 3hq 3rb 3wf 3zo 4ai 4ao 4dd 4er 4ei
4fa 4ft 4eg 4go 4gr 4xy 4hx 4iz 4it 4iq 4iv 4jr 4iy 4jx
4jk 4kp 4kb 4my 4pp 4pu 4pr 4qi 4ua 4ux 4vy 5ahp
5in 5iw 5ev 5kc 5il 5nb 5uk 5ux 5za 5zq 5ql 6afs 6av
6akm 6ats 6agr 6ahm 6ahs 6aij 6aww 6bsz 6bt 6bro
6eua 6euw 6ewg 6ru 6xi 6zac 7em 7hd 7if 7iw 7pu
7py 7wc 7wu 7xi 7yi 7ya 7yz 9aw 9eo 9ex 9ek 9bt
9egn 9de 9dem 9el 9ey 9dkr 9dhr 9dku 9dol 9dpp
9qr 9sj 9fw 9wt ne-1an ne-1aq ne-1ae ne-1ar ne-1dd
ne-1ab ne-2by ne-3ax ne-3es ne-3zb ne-3at ne-5go
oa-3oa be-4rs se-2ld ef-8eq ef-8bi ef-3go ef-8yor ef-8jn
eg-2nm eg-2lz eg-2kf eg-2kt eg-2go eg-2qb ek-y5
en-owc en-pb3 nkf awuz bwf ni2 gn2 kegk nidk pkx
wnp voq ntt nm-5c nm-9a nm-1k.

1MR, E. P. Drozck, 31 Dyer Avenue, Milton, Mass.

6agt 6abm 6ars 6ach 6adk 6bjl 6biv 6cub 6euw 6eto
6ct 6dgr 6eck 6ea 6fz 6ih 6ju 6kb 6pv 6ta 6hd 6zat 7ek
7uc 7go ne-1an ne-1rm nm-1h se-fr5 sb-1aa sb-1ad
ne-4dt ne-9an am-1n nm-1j se-fr5 sb-1aa sb-1ad
sb-1ap sb-1ax sb-1aw sb-2ab sb-2ad sb-2af sb-5ad
oa-1cw oa-5kn oa-4xg ex-2xa ex-3ai ex-1ao su-1eg
opm eg-6lj eg-2xv nang aol dx8 sgl av7 j5 geda.

2AMG, Bernard Fein, 900 Riverside Dr.,
New York City, N. Y.

1aal 1adl 1ahb 1ahu 1anz 1ans -aoq 1aox 1aqt 1aaj
1aaj 1ana late 1atz 1asp 1aom 1bqd 1cau 1ckk 1cmp
1evz 1di 1dq 1lm 1rf 1iu 3afa 3afw 3ahp 3bn 3cin 3ep
3ki 3qw 3ru 3rs 3rm 4ry 4xe 5aqy 5ol 6awa 6bqv
6hhz 6bh 6bz 6bx 6cmw 6ayj 6cvx 6hm 6ia 6pw

6sb 6ud 6vr 7aix 7st 7vq 8ado 8adc 8alr 8avo 8box
8buy 8ccq 8cil 8cnr 8cuv 8cu 8cpl 8cyn 8dbb 8dgp 8dri
8dsh 8sv 8ve 8vg 9ama 9ack 9esh 9dol 9ejr All Amer-
ican except 6 and 7 in daylight. nclaq ne-2bn
ne-3il ne-3zb ne-4dw ne-8azs ne-9am nm-1j nm-1z
nm-sda sb-1ac sb-1ad sb-1ap sb-2ab nq-8kp np-nau
nj-2pz en-ppt ef-fvw gbl pjc eb3 nkf aa7.

2CMX, S. J. Meyer, 240 Washington Ave.,
Rutherford, N. J.

6el 6fr 6nw 6yb 6at 6afp 6ayj 6bam 6bge 6bhi 6bjg
6clk 6cuc 6cys 6cz 7de 7iz 7jc 7ng 7ny 7pu 7uo
eh-4ax sb-1wr ef-8hf ef-8gl ef-8pm ef-8yor eg-2cc
eg-2jb eg-2am eg-2d eg-5ad eg-5by eg-5sz eg-6iv
eo-2it ep-1aj nq-7cx.

2AKJ, Vincent Suhoski, P. O. Box 705,
Freehold, N. J.

(Heard during November)

6to 6zat 6caw 6bws 6eb 6cuc 6azy 6chy 6clt 6mm
6agr 6hea 6dn 6ay 6biv 6ks 6mu 6hm 6abm 6am
6oua 6dcf 6amg 6ecu 6kb 6adt 6bhz 6clt 6xg 6ld
6bcj 6bil 6dan 6aej 6kw 6adn 6cm 6boy 6adp 6bil
6by 6dp 6dvj 6ct 6coo 6ro 6ou 6qbj 6eck 6cgc 6auf
6fg 6bvw 6bgb 6cel 6bhr 6bb 6daq 6aat 6dqc 6bot
6yz 6vd 6lv 7ay 7vh 7or 7wu 7us 7bu 77g 7gj 7ec 7eq
7oy 7jc ne-1ar ne-1dm ne-1da ne-2ax ne-3mf ne-4dw
ne-4ea ne-4aq ne-4hs ne-9ac eg-2lz eg-5dh eg-5nz
eg-6td eg-6og ef-8yor ef-8ct ef-8hu ef-8ya ef-8kp
ef-8ep ef-8bs ef-8jf ef-8ik ef-8ca ef-8jc ef-8jj ef-8ix
ef-8gi ef-8fl ef-8ssw ef-8jua ef-8tis fm-8st oz-lax
oz-2xa oz-6dn oa-2yi oa-2dw oa-2hp oa-2ds oa-3ba
sb-1am sb-1ib sb-1aw sb-1aa sb-1ak sb-1ao sb-1aq
sb-1ax sb-1al sb-1ad sb-1an sb-1ik sb-1ic sb-2af sb-2ab
sb-2ag sb-2q sb-5aa sb-5af sb-5nt sa-af1 sa-bal sa-1pl
sa-pa2 sa-dw4 sa-1p8 sa-de8 su-2ak su-2as su-2af
su-2ah su-1am su-1cd su-1bu su-1fb nm-1j nm-5c nm-5n
nm-9a ei-1ay ei-1ma nj-2pz np-4sa np-4jq nq-8kp
eb-3ab se-2ld fo-a3x se-1fg ek-4abf aj-1kk abi aab
oa3ba o2as 1pz gbk aaz 98x pts aab1 ei-acd ocdj.

J. Gray McAllister, Jr., Box 243, Hamden-
Sidney, Va.

oa-2bh oa-2cm oa-2cs oa-2ds oa-2tm oa-4bd oa-5bo
oa-5wh eb-3aa sb-2ab sb-2af sb-2ag sb-6qo sb-8q4
nc-1cx ne-2an ne-2ax ne-2bv ne-2fo ne-2go ne-3fc
nc-3jl nc-3xi nc-3zb nc-4aq nc-4dw nc-4dy nc-4ja
se-2ah se-2as se-2ld ef-8ca ef-8cl ef-8ct ef-8dl ef-8gl
ef-8ix ef-8jf ef-8yor fm-8ma eg-2kf se-1fg oh-6axw
ei-acd ei-1eo ei-1gw ni-8nl nj-2pz ek-4abf nm-1e
nm-1j nm-9a nm-5h nm-xc2 fo-a3b fo-a50 nm-4na
nq-8kp sa-af1 su-1cd su-2ak oz-1ao oz-1ax oz-2xa
oz-3ai oz-3aj oz-3ar oz-4az ank octn rxy shv.

Willard F. Hunton, Falls Church, Va.

oa-2mh oa-5ma eb-3aa eb-3ab eb-3w sb-1aa sb-1ab
sb-1ac sb-1ad sb-1aj sb-1ak sb-1al sb-1am
sb-1ao sb-1aq sb-1ar sb-1au sb-1aw sb-1ax sb-1bd
sb-1bi sb-1a sb-1ib sb-2ab sb-2af sb-2ag sb-2ak sb-2bi
sb-5aa sb-5ad sb-6q sb-6qt sb-9qa sb-sq2 sb-sq4 se-2ab
se-2ac se-2ah se-2ar se-2as se-2ld se-4ac se-4ad se-4ar
ef-8ba ef-8bp ef-8bx ef-8cd ef-8cf ef-8cl ef-8en ef-8es
ef-8ct ef-8eo ef-8dl ef-8ee ef-8fl ef-8ij ef-8jk ef-8kz
ef-8gi ef-8gt ef-8gm ef-8gra ef-8ix ef-8jf ef-8jn
ef-8kf ef-8kt ef-8nn ef-8pd ef-8rb ef-8rf ef-8ssw
ef-8st ef-8tis ef-8tuv ef-8udi ef-8xy ef-8yor ef-18gr
ef-ha3 eg-lak eg-2b eg-2cc eg-2kf eg-2nm eg-2od
eg-2wj eg-5dh eg-5is eg-5ma eg-5nj eg-5pm eg-5pz
eg-6nf eg-6og eg-6td se-1fg ei-1as ei-1au ei-1ay ei-1co
ei-1er ei-2vq ei-acd ek-4abf nm-1e nm-1j nm-5c nm-9a
nm-1h nm-cyy nm-oro fo-a3b fo-a4l fo-a4z fo-a50
fo-a5z fo-1ar sa-af1 sa-cb8 sa-dm2 sa-die8 sa-dh5 sa-dx8
sg-dz9 sa-ce2 sa-f6 sa-fh4 eb-1ch su-1am su-1hr
su-1cd su-1cg su-2ak su-1waa oz-1ax oz-2ae oz-4ac.

ef-8yor jhp eg-2bi eg-2jb eg-2nh eg-2nm eg-5hs eg-5vk eg-6yd eo-2it eo-6mu ei-aced ei-lau ei-lay ei-ico ei-lgw nj-2pz ek-4ahg ek-4yab nm-1j nm-9a nm-jh fo-83b fo-85o fo-1sr nq-8kp sa-a1l sa-dz9 su-2ak oz-4aa oikp sqiq.

sc-2aa sc-2ld sc-4aq aaj aa7 amx 9ze at sea jm-2pz oedj nkf nauv nau ef-5ef wvdo naw bam abi 5ib dx8.

8AMU, C. V. Frisinger, 120 Hilson Ave., Mt. Oliver P. O., Pittsburg, Pa. (Heard during November)

lad 2acy 3dkk 4dd 5dt 5qs 5tt 6adp 6awq 6bif 6cww 6cuw 6daq 7al 7dk 7ek 7ob 7or 7wu 9akm 9bye oa-a7 ne-8kt ne-ldm sb-1aa sb-1bi sb-1ip sb-2af sb-6qa ef-8ip ef-8yor eo-2it brs36 kjoe nq-2ic.

8CDB, Robert Wood, 860 Maryland Ave., Syracuse, N. Y. (Heard between Nov. 1 and Nov. 18)

ei-aced ei-ico ef-8gi ef-8ss ef-8ya ef-8fk of-8dk of-8tok eg-2od eg-6kk eg-6ox eg-2nb eg-2ec sb-5aa sb-2ag sb-5ab sb-1ac sb-5ar fo-a6n fo-a3e fo-a5z ep-3or am-2se op-1dl op-1hp eb-4rs ee-car4l oz-3af oz-4aa oz-4ag oz-3ac oz-3ad oz-4ak oz-4mm oa-2gi oa-3ad 6aih 6awt.

8DCW, Saranac, Michigan (During November)

6aan 6abc 6abm 6ach 6acz 6adp 6afp 6agd 6ahp 6amm 6are 6ary 6aut 6awq 6bbq 6bch 6bcb 6bge 6bhi 6bhr 6bil 6bih 6bjf 6brm 6btm 6bux 6bve 6bvw 6byy 6bxj 6bxv 6bye 6byh 6byz 6bzf 6bzn 6cad 6cen 6cdz 6chn 6chq 6cht 6cmt 6cnm 6cnn 6cos 6cpn 6csd 6scx 6ctx 6cuu 6cuw 6cvw 6cxl 6cyu 6czb 6dam 6dan 6daq 6ddo 6am 6bq 6dn 6fa 6ga 6hj 6kd 6ll 6mu 6or 6ty 6ua 6yd 7abi 7adg 7aib 7bb 7bd 7dk 7ej 7fe 7gb 7jk 7kq 7ld 7np 7or 7og 7ts 7tx 7xt 7ya oa-2bb oa-2ca oa-2hc oa-2jy oa-2ry oa-2sh oa-2yi oa-3de oa-3ef oa-3em oa-4hd oa-5bg oa-5hg oa-7ew oa-7es na-4ni na-7kn na-wvdo eb-h5 eb-n3 eb-w5 eb-8aa sb-1ak sb-1al sb-1am sb-1ao sb-1aw sb-1ib sb-2ab sb-2af sb-2ag sb-2ia sb-5aa sb-6b sb-suij oa-lan ne-1dd ne-1dm ne-2fo ne-3adm ne-3et ne-3do ne-3jl ne-3ni ne-xj ne-4al ne-4ck ne-4hs ne-5ar ne-5et ne-8aw se-2ab se-2ah se-2as se-2ld se-nad ee-earl ef-8bbk ef-8cl ef-8ct ef-8fi ef-8fk ef-8gi ef-8gm ef-8ha ef-8ia ef-8ix ef-8jc ef-8jn ef-8kl ef-8kb ef-8pd ef-8sw ef-8tis ef-8udi ef-8yor ef-8yv eg-2cc eg-2if eg-2nm eg-2td eg-2oq eg-2qb eg-2hp eg-2zc eg-5by eg-5dh eg-5hy eg-5ku eg-5mq eg-5ul eg-5vl eg-5wq eg-6vp eg-6yd se-1fg eo-2it eo-1lb eg-6nh oh-6axw oh-6def oh-6dea ei-lau ei-lay ei-ico ei-lgw ei-lma ei-aced nj-2pz ei-4abf nm-1j nm-1n nm-5b nm-9a nm-cvy nm-jh nm-xc2 fo-a3b fo-a3c fo-a5o fo-a5t np-4iq np-9c nq-8kp sa-a1l sa-bal sa-de8 sa-dh5 su-1bu su-led su-2ak oz-2ac oz-2ae oz-2gc oz-2xa oz-3aj oz-3ar oz-4ac ank aqe ardi fut giup hik ne2a oerb octn rrp siv sue2.

8DED, William and Russell Sackers, 53 East 7th Street, Holland, Michigan.

6aah 6aas 6abg 6abm 6ab 6adp 6agd 6age 6agr 6ahs 6ain 6aix 6ajm 6akm 6alg 6am 6anp 6aw 6ao 6are 6aut 6ave 6avz 6bam 6bbq 6bch 6ben 6bhi 6bjb 6bjl 6bpn 6bs 6bx 6bzf 6bvh 6bvo 6bvq 6bvx 6bws 6byy 6bs 6bxj 6bxz 6bhw 6bvy 6bzv 6bzq 6bz 6ccm 6czm 6cwg 6ckh 6che 6chn 6cky 6ciz 6en 6enn 6co 6ca 6cam 6cay 6ect 6ctx 6cuu 6cuc 6ou 6cuw 6emz 6eub 6evh 6eyn 6eyu 6eww 6dn 6er 6gw 6ew 6ku 6mi 6mu 6ap 6oi 6ub 6ud 6uo 6vr 6ht 6li 6ur 6ug 6zat 6zbi 6bbx 7aao 7afg 7al 7av 7bb 7dd 7fl 7zi 7hp 7or 7ok 7oo 7jt 7uw 7uh 7vv oa-3ef oa-3an oa-3td oa-2yi oa-2bb oa-2m oa-4ac oa-4yn oa-5wh oa-5hg oa-7cw nb-4eb sb-1am sb-1aa sb-1af sb-1ax sb-1ib sb-1ap sb-1ac sb-1ba sb-2af sb-2ag sb-2ab sb-5aa sb-5ab sb-6qa sb-1aw ne-1bf ne-1dd ne-2bg ne-3in ne-3adm ne-3jl ne-3nj ne-3wz ne-3xi ne-3zb ne-4bb ne-4dq ne-4dw ne-5ef ne-4hs ne-4gw oh-6asr oh-6dea nm-laf nm-laa nm-1e nm-1j nm-5b nm-9a nm-cvy (sm-1p) fo-a3b fo-a4z fo-a5o sa-8bs sa-de8 sa-dh5 sa-1p ef-ctm ef-xeu ef-8ix ef-8if ef-8gm ef-8jn ef-8et ef-8xy ef-8yor ef-8kl ef-octn so-lbu su-lam su-led su-lcg su-2ak op-wve oz-lax oz-2ae oz-2ak oz-2xa oz-4ac nq-5ry nq-8kp np-4sa ei-ico se-2ac

9DSQ, Paul D. Records, Glenwood, Ia.

1aao 1adm 1adw laei laga lamd laox lasu lave lavl law lawe lawr laex lbem lbez lbhx lbms lbsc lea leaw lchw lef lel lemf lid lidl lduq idx ldx lfg lga lie lij lif lly lml lory lor lrv luy luv lxm lzd lzw 2adz 2agt 2ah 2ahq 2ak 2al 2am 2aqk 2ar 2as 2avr 2axy 2az 2bbz 2bc 2bu 2buo 2cc 2cco 2cuq 2evj 2exl 2doz 2dzo 2fe 2jm 2ly 2mu 2od 2rk 2xi 2xaf 3acw 3boa 3bsp 3bua 3bw 3cd 3gj 3gp 3jl 3ly 3my 3qs 3wf 4ag 4ay 4co 4dd 4ft 4pf 4sb 4sc 4tn 6aaf 6adi 6ahm 6am 6arc 6axw 6bbq 6bhi 6bib 6bpl 6bpn 6brm 6bvv 6bvy 6bxl 6cqm 6erc 6scx 6ewq 6dar 6or 6pr 6qu 6sg 6uq 6za 7df 7ht 7or 7ug 7vh ee-earl ee-earp ee-eary oa-2ak oa-2bb oa-2ca oa-2no oa-3yo oa-4an oa-7cw sb-2ab eg-2cc eg-2bz eg-2ob nm-1c nm-1e nm-1k nm-1g nm-1x nm-5b nm-9a oz-2ac oz-2ma oz-2ae oz-2ga oz-4aa oz-4am oz-4as se-2ld ef-8ka oh-fxl rau.

9AGG, W. J. Romanouski, 621 East 7th Street, Peru, Ill.

oa-2bb oa-2bk oa-2cg oa-2sh oa-2yi oa-3en oa-3em oa-3kb oa-3my oa-3xo oa-4bd oa-5kn oa-5nb oa-5nd sb-l2 sb-2ab ef-8gi ef-8yor ei-lai nm-jh nm-5c nm-9a fo-2me oz-lax oz-2ab oz-2bg oz-2br oa-2xc oa-2xa oz-6ai oz-3ar oz-3xb oz-4aa oz-4ac oz-4am oz-4ar aaz abl gjk hik qea xam xda.

9KM, Clarence Falstrom, 1866 Delavan Avenue, Kansas City, Kansas. (Heard during October and November)

oa-2bb oa-2bk oa-2yi oa-3em oa-3ls oa-4an oa-4am oa-5bg oa-5rm oa-5vh oa-7ca oa-7la oa-7w sb-law sb-lba sb-1ib ne-2bg ne-3fc ne-4ek ne-5ac ne-5ef ne-9ac ne-9ed se-2ah se-2ar se-2ld ef-2ef ef-8ic ef-8jn eg-2nm eg-2od eg-5lf nm-1j nm-1n nm-5b nm-9a nm-xc5l fo-a3b fo-a3e fo-a3z fo-a4z fo-a5o nq-8kp xam su-2ak oz-lax oz-2ac oz-4aa oz-4am aa7 w3fw wvdo 8ma am-2se.

op-1BD, Camp Nichols, Ritzel, P. I. (Heard during October)

oa-2ag oa-2bb oa-2cg oa-2dy oa-2so oa-2yh oa-2yi oa-3bd oa-3ls oa-4an oa-4rb oa-5bw oa-5hr oa-5kn oa-5wa oa-7gh oa-7ca oa-7cw oa-8ac oa-2bk od-8k3 od-8k3 sb-lab sb-lac sb-lad sb-lak sb-lan sb-lam sb-laq sb-law sb-lbi sb-2ab sb-2ac sb-2ag sb-2an sb-2am sb-6qb sb-sni se-2as od-andir ef-8jc ef-8jn ef-8kl ef-8ml ef-8rt ef-8tv ef-8u ef-8w ac-8xx eg-2bz eg-2z eg-2nm eg-2od eg-5nj eg-5by oh-6asr oh-6buc oh-6def oh-6nl oh-6sh ho-fil oh-fxl ho-dm2 ei-lau ei-lgw aj-laa aj-lgs aj-lkk aj-lm aj-llt aj-lmk aj-lmt aj-lqq aj-lsh aj-lsk aj-lsm aj-lso aj-lts aj-lzb aj-2xy aj-3qq aj-3aa aj-3yz aj-3xz en-rdm fo-1sr fo-a3e fo-a3k fo-a4e fo-a4z fo-a4v fo-a5h fo-a5o fo-a5s fo-a5x fo-a5z fo-a6n fo-a6r fo-a6y fo-a7b fo-a7h fo-whn ep-9aa rxy ed-2eo em-3xx em-sud em-smtn sa-lba su-1bu su-1cd su-2ak su-2ax oz-2ac oz-2xa oz-2br oz-3xb oz-4aa oz-4ac aga agb agc anc and anf asd arex h82 bxy fw gbk gbm giup gkz glky hva hvn ial jbi jyz kel ket klc kut oedj pke plh rrr van vrs wuce wvy 20 meters. af-1b oa-2ae oa-2ya oz-2ac am-2se eg-2nm 6kbb agc aga agb wll 2xs 2xi oh-bam 5adc 5ad 5agw 5aio 5ahl 5amy 5am 5aur 5gx 5he 5jk 5lf 5ma 5pk 5uk 6zat 6rw 6rn 6bx 6ary 6arh 6ell 6am 6bv 6vni 6ma 6bxj 6bg 6bz 6bmw 6ct 6bzv 6bvy 6kb 6ac 6bvz 6aw 6to 6bay 6ag 6ajm 6rj 6atm 6agc 6bpg 6in 6cs 6xb 6bv 6bxz 6dcq 6akp 6cax 6bx 6ans 6bba 6ddo 6adp 6kv 6bpa 6ea 6bhr 6fa 6kb 6aks 6zac 7tu 7it 7bb 9dpw 9evy 9bez 9dkm 9aek 9edw.

E. S. Yorston, Hawthorne Road, Caulfield, Melbourne, Victoria, Australia

1hr 1aao 1au lump 1dj 1akz 1rm 1rx 1bbq 1bjx 1fi 1uzd 1zs 1uw 1axa 2kd 2bw 2bg 2ry 2ns 2eme 2me 2amj 2xaf 2kb 2lma 2bv 2mn 2kg 2cx 2czr 3gn 3ra 3lw 3agu 3afq 3at 3uy 3zo 4aa 4b 4cl 4f1 4go 4ar 4mv 4si 4rn 4vi 4aa 4ft 4dd 4kj 5il 5hd 5uk 5agu 5ft 5aab 5ls 5yb 5eh 5aj 5nw 5akl 5auz 5akt 5lo 5ua 5vu 5ke 5agw 5pi 5ame 5adt 5ado 5amt 5mw 5nn 5aec 5hu 5agn 5fc 5aq 5asu 5atf 5ql 5ap 5bx

5aua 5de 5dz 6ae 6aun 6avj 6adm 6dcu 6aiw 6bhz
6awt 6ais 6cjp 6oi 6bil 6dmt 6tm 6eub 6gzm 6ho 6eto
6gk 6hm 6aff 6bu 6emg 6xi 6emu 6rw 6fp 6ahp 6nx
6gk 6axp 6da oh-6hdl 6jin 6bbb 6rf 6hdp 6akm 6tz
6eb 6bgo 6mj 6egw 6ct 6eel 6nck 6edq 6abg 6bwi
6huc 6pr 6ij 6bty 6dcy arx 6mb 6bhr 6ajm 6ih
6eww 6alt 6bge 6bju 6cua 6hjt 6bxc 6bvm 6vy 6chl
6mu 6akx 6bhr 6bum 6alg 6alt 6btw 6bgo 6baf 6akp
6axw 6bxd 6chl 6bxi 6kd 6cz 6chy 6aiz 6emq 6dw
6bhm 6bht 6abg 6jn 6hj 6adv 6adp 6ae 6rp 6act
6ewm 6amm 7io 7it 7sm 7df 7eh 7gz 7nt 7mn 7mf
7mu 7ww 7ud 7cs 8hlp 8yy 8gz 8hf 8bq 8adg 8bau
8se 8bee 8dbz 8bpl 8clr 8pi 8ke 8nhn 8iz 8ajn 8tk
8oq 8bbl 8dgp 8aj 8ajm 9bsz 9eez 9bsq 9ud 9hp 9or
9xi 9mr 9edp 9bjm 9rff 9fjr 9che 9ahj 9ua 9rx 9doq
9dng 9axb 9agw 9ara 9cu 9cor 9enc 9zt 9bdd 9cua
9ew 9drd 9ek 9end 9aek 9udud 9diz 9ded 9abr 9dbb
9evy 9day 9adv 9evn 9che 9ead 9etg 9dbf 9dr 9bht
9cpq 9hp 9ppq oa-2bl oa-2ky oa-2gb oa-2fc oa-2uc
oa-2rc oa-2ze oa-2yi oa-2yh oa-2lo oa-2mh oa-2es
oa-2dc oa-2lm oa-ki oa-2yn oa-2nm oa-2cm oa-2sw
oa-2tm oa-2as oa-2ob oa-2eg oa-2lk oa-2bw oa-2ga
oa-2bh oa-2eo oa-2bb oa-2gw oa-2rd oa-2ij oa-2dj
oa-2wh oa-2bv oa-2ui oa-2dy oa-2jt oa-2ok oa-2jp
oa-2jr oa-2ja oa-2my oa-2ds oa-2sh oa-2cy oa-2xi oa-2oq
oa-2ad oa-2ap oa-2ks oa-2mr oa-2yx oa-2fp oa-2sr
oa-2se oa-2bd oa-2lo oa-2ar oa-2uz oa-2me oa-2ux
oa-2du oa-2bp oa-2ks oa-2cr oa-2dp oa-2im oa-2ef
oa-2bh oa-2ep oa-2jp oa-2by oa-2bu oa-2sw oa-2dg
oa-2hr oa-2bk oa-2yn oa-2bl oa-2jr oa-2fr oa-2ot
oa-2wm oa-2lm oa-2ya oa-2wa oa-2cq oa-2am oa-2dc
oa-2ne oa-2aj oa-2rm oa-2sn oa-2xo oa-2xz oa-2gh
oa-2kb oa-2ls oa-2el oa-2my oa-2ak oa-2ev oa-2ui
oa-2hm oa-2gn oa-2ig oa-2ra oa-2sz oa-2jij oa-2rk
oa-2wc oa-2dd oa-2io oa-2gl oa-2px oa-2en oa-2an
oa-2as oa-2ak oa-2rb oa-2wi oa-2cm oa-2wb oa-2sn
oa-2ib oa-2ck oa-2am oa-2kr oa-2ad oa-2do oa-2go
oa-2ge oa-2hw oa-2ug oa-2cg oa-2ay oa-2if oa-2di
oa-2da oa-2vg oa-2nn oa-2rm oa-2dn oa-2el oa-2bw
oa-2bg oa-2ub oa-2wh oa-2ma oa-2ng oa-2ag oa-2wf
oa-2rw oa-2gm oa-2am oa-2kx oa-2sa oa-2mu oa-2wp
oa-2kk oa-2ks oa-2xl oa-2hx oa-2ms oa-2bq oa-2cs
oa-2la oa-2ew oa-2dx oa-2hl oa-2om gdvb npv nba
nkf vs nxf npm naj ndj nie npg vin vim nkv ngo
nog nef nnp nk npu kie kdka yis bam eca kfuh
dip suc eem cf-fl ef-fw ef-ceng ef-ocdj ef-8jn ef-8if
ef-8gz ef-8es ef-8kf ef-8gi ef-8gm ef-8no ef-8hf
ef-8iz ef-8ee ef-fnk ef-8di ef-8ag ef-8ix ef-8tuf
ef-fbio ef-8he ef-8woz ef-8hu ef-8fb ef-ocdb ef-ffq
ef-8fj ef-8ku fe-8fio fm-8ma af-hva af-ffz af-hvn
af-8fio af-glq af-bxy fh-8bri ek-yp ek-y5 ek-vs ek-iz
ek-k5 ek-k7 ap-ghb ap-khp ap-6zk eb-5k eb-4zz eb-ali
eb-2r em-ak em-enc em-pda em-ppr em-suc em-smtn
em-smwf em-ssc ex-4aa ex-earl ex-ar22 ex-ar9
eg-2my eg-2kf eg-2xy eg-2iz eg-2dc eg-2av eg-2xa
eg-2bz eg-2ew eg-2sz eg-2nm eg-2mz eg-5ra eg-5az
eg-5rr eg-5dh eg-5ab eg-5by eg-6td eg-6vd eg-6pr
eg-6og eg-6hs ni-2ae su-jep su-1cd su-lga ai-hhk
ai-2ak au-rlo au-tuk fo-a3e fo-a3f fo-a6s fo-a6a fo-a6n
am-2se ei-ler ei-ldo ei-lgw ei-lco ei-lau ei-lap
ei-lmm ei-lrm ei-lwm ei-lat ei-nec ei-lgw ne-3nc
nc-3ac nc-9ai aj-rjs aj-lzq aj-lsm aj-3aa aj-lts aj-3az
aj-3kk sa-1eo sa-cb8 ep-3or ep-cd8 op-lhr op-lau
op-lbd op-3aa op-lat op-las op-ldl nm-1j nm-xbe
nm-xam ei-7xx oz-laj oz-lrw oz-wap oz-lbk oz-lax
oz-lao oz-lra oz-2aq oz-2gc oz-2ak oz-2bx oz-2xa
oz-2bs oz-2al oz-3ag oz-3af oz-3ad oz-3xb oz-4aa
oz-4am oz-4ax oz-4ak oz-4ad oz-4ac oz-4av sb-laq
sb-laz sb-ld es-2co.

8jm 8ve 8vv 8zac 9akf 9axh 9bde 9bjw 9bjz 9bvp
9eca 9ecs 9eej 9evn 9exa 9dke 9dng 9eag 9ell 9ez
9fu 9mc ne-lac ne-lar ne-2fo ne-3fo ne-9al.

ef-8YNB

1ajz lads lcra lbjz lnx lle lau lzt 3bwt 4ev 2tp
9bzs.

eg-2AJL, R. W. Arnott, The Garth, Monmouth, England

(80-meter band between Nov. 1st and Dec. 12th)

1adw 1dq 1bjk 1sl 1aci 1mp 1rd 1ch 1xj 1vc 1lc 1mk
1bdq 2asd 2anx 2bc 2ctf 2evj 2ajq 2ob 2ait 2zc 2aev
2zv 2tp 2bvh 2cah 2av 2of 2gp 2rc 2rn 2sv 2ry
2aad 2eco 2ue 2akj 2ayd 2rh 2bf 2bth 2bvr 2avo
2arg 2afq 2cev 2enc 2bht 2adk sb-lwr sb-lai sb-5ab
2nni.

W. H. Talbott-Smith, 16 Farman Rd., Coventry, England

(Heard between Oct. 31st and Nov. 7th)

1uzk lak laao layl lakz laay laxa lbez lejh lenz
1ch 1cmf lpe lqz lzs lzv lzw 2aoo 2afz 2ay 2ay
2ba 2ca 2ctn 2cc 2erb 2cmf 2ld 2nz 2oq 2vz 2xaf
2xg 2auv 2hg 2jo 2iw 2zo 2dd 2ak 2uz 2jo 2ecq 2bet
2buv sb-lau sb-lad sb-lbi sb-ld sb-2am sb-2ag
sb-2af sb-2ia sb-2as sb-2bf sb-plak sb-2ak sb-2am
sb-lar sb-1vl sb-law sb-lbe sb-lbi sb-lia sb-1lb sb-lbn
su-lam sa-2db.

ei-1CO, G. L. Colonnetti, Via Maria Vittoria N.24, Torino, Italy

1aac laao laei lads laf laff lahx lakz lahr lamd
lapy laxa lben lbhm lbke lch lckp lcmp lomp
lka lmy lrd luu lzw 2aan 2ao 2agq 2am 2amj
2abp 2bbd 2bqh 2bvg 2bum 2erb 2eyz 2pt 2px 2tp
2acf 2evd 2iv 2mv 2zo 4bx 4ft 4hx 4it 4ux 4yv
4wj 5abk 5adg 5ahc 5aly 5ae 5bbe 5bf 5bth 5cdv
5dx 5jz 5ze 5zae 5bmx 5epq 5drs 5eji 5hp oa-2bb
oa-2cm oa-2cs oa-3xo oa-4-7es oa-7hl sb-laf sb-lak
sb-laj sb-lam sb-lap sb-lao sb-law sb-lax sb-lbd
sb-lbg sb-lbh sb-lbi sb-lca sb-lhb sb-2ab sb-2af
sb-2as sb-2ao sb-2fo sb-5ad sb-9na ne-led ne-2be
se-2ab se-2ah se-2ld af-8cq nm-lj nm-lm ni-3iw
fo-a3b fo-a5x fo-a6n np-4je np-4sa sa-aas sa-d2
sa-f66 sa-ga2 su-led su-2ak oz-2ac oz-2ae oz-2xa
oz-2bg oz-2br oz-2bs oz-3at oz-4am nad nxf niss tuk
20 meter band. lcmp lrd 2cty 2axa 9dbw af-lb
ei-lx oz-2ac.

nr-015, J. L. Thissen, Herungerweg 110, Venlo, Holland

laao lamd lack laei ldjk leh lcmp lekp ldm
1kl 1kmx 1nq 1rd 1sl 1sw 1yb 2ait 2ah 2agq 2evj
2exb 2czr 2nz 2pp 2sz 2uo 2xad 2zv 2y 2yd 3nr
3ql 4ch 8ecq 9zt oa-2ac oa-2em sb-lac sb-lad sb-laf
sb-lag sb-lak sb-lam sb-lan sb-lao sb-lap sb-lax
sb-2ab sb-2af sb-2ag sb-2as sb-5aa sb-5ab sb-5ac sb-6qa
sb-6qb sb-poa sb-sql sb-ptr sb-pts ne-lak se-2ab
se-3ij se-9te fe-f2 af-lb nm-xc55 fo-a3b fo-a3e fo-a41
fo-a6n fr-3fl fr-3gb op-lhr op-3aa op-ajd op-nuq
np-4ja np-4je np-4rl np-4rx np-4sa sa-aas sa-bal
sa-bl8 sa-cb3 sa-cb8 sa-d5 sa-d6 sa-dd7 sa-de2
sa-xt su-lar su-led su-lfb su-2ak su-2ar oz-3ar and
anf hva kel nab naw nkf pjc suc spj wqo will ardi.

se-1EG, Edmundo Guevara R., Vileun, Chile, S. A. 20-meter band

agg bwff pex pil lxs.

RO91, C. Conte, wr Allee du Rocher, Clighy-s/-Bois (S.-&O), France.

1aac laei ladd ladm lads laer laic laic lamd laox
laor lavi laxa lazd lazk lazz layl lbam lbbl lbb
lbd lbez lbyk lbms lbfl lbgb lcaw lckp lcki lcyo lemf
leue lej ley lga lie lkl lmy lor lpy lqb lrd lrf lsm lrv
lsw luu lvy lzx lxm lzy lxm lzs lxy lbux 2abp
2abw 2ags 2aby 2aym 2anx 2arm 2ayz 2bum 2buy
2bo 2bv 2bvh 2caw 2eel 2erb 2ctn 2evy 2dm 2fy 2kx
2nz 2om 2pv 2px 2rs 2tp 2uo 2xaf 2ad 2ael 2afa
2agp 2aha 2awg 2ay 2bm 2bms 2bqj 2buw 2bwt 2eky
2eki 2dw 2ep 2gw 2jn 2jo 2ld 2lv 2mp 2of 2ow 2tr
2wf 2ak 2bl 2dd 2fl 2go 2hb 2rm 2sl 2svz 2amw
2ax 2ap 2ash 2aul 2ev 2jd 2oa 2yf 2ek 2adx 2afq
2akk 2ali 2ana 2avs 2bbs 2bbw 2bda 2hrd 2hrc 2hsu
2bt 2bth 2cal 2ecq 2esc 2sd 2shu 2sdf 2dmz 2sdy



You have noted in the new Amateur Call Books (Government) that the station calls have been indexed by town and state, a great help to the relay man who wants to find a list of the stations in the town he has msgs for. FB and thanks, Mr. Hoover.

Correspondence

The Publishers of QST assume no responsibility for statements made herein by correspondents



Greetings From South Africa

Headquarters,
The S.A.R.R.L.
Johannesburg,
South Africa.

Dear Mr. Maxim:

By the time this letter reaches you our thoughts will be with you and the boys across there, and we shall be thinking of you spending a real old Christmas with snow and cold winds which are so necessary to make our idea of Christmas complete. Here of course we are at midsummer, which state does not assist in the complete destruction of unlimited portions of roast turkey and Christmas pudding.

On behalf of the hams in South Africa and particularly the members of the S.A.R.R.L., I wish to express to you our sincere good wishes for the festive season. We thank you for the assistance you have given us and we hope that our splendid relationship will continue from year to year. Will you kindly convey the greetings of my Executive Committee to the Staff at Hq. on your side? We like to feel that we are trying to run our League on lines similar to the A.R.R.L. We fail badly at times but are never disheartened. Our members are small in number but the boys are big in their desire to help along the good work of International Amateur Radio, which will lead to international peace surely.

Be sure to ask any hams who contemplate visiting South Africa during the coming months to get in touch with me so that I can arrange with our lads at the coast to meet them and extend to them that feeling of brotherhood which exists now across the air, and which we know we shall receive if and when we visit your country.

With kindest wishes and 73, OM.

Yours very sincerely,
—Raymond Coombs, Honorary
Org. Secretary.

High Voltage Voltmeters

1640-50 Walnut St.,
Chicago, Ill.

Editor, QST:

The writer's attention has been called to a number of articles in the radio press along the lines given below and which we feel are misleading to the general public. We give below a brief description of what has been

said, the reaction of the radio builder and the reasons for our questioning the wisdom of these statements.

A number of articles has appeared in the radio press in which it is stated that a high resistance voltmeter may be made by connecting in series a low reading milliammeter and a high resistance of the proper value. For instance, a milliammeter reading one milliamper full scale used in conjunction with a 0.2-megohm resistance, will make a legitimate voltmeter, reading 200 volts full scale. It is, however, very difficult to obtain on the open market a high resistance of the proper accuracy and made of the proper material for such a purpose. The average man will go to a radio store and purchase a grid leak or other high resistance which is entirely unsuitable for the work on hand.

That is, a 0.2-megohm grid leak rarely has a resistance of 0.2 megohm. Grid leaks are usually adjusted by the large manufacturers to come within 10 percent, and many on the market are far from being this accurate. The voltage readings will be no better than the accuracy of the grid leak.

Further, every grid leak has a material temperature coefficient; those of carbon or inked paper having a negative coefficient and some other types positive. They will vary as much as $\frac{1}{2}$ percent per degree Fahrenheit. Even though compensated for room temperature, the current through the leak will usually heat it so that its temperature is considerably above that of the room and more errors result.

It should be understood of course, that for their purpose grid leaks are entirely satisfactory since a variation of 10 percent in the value of the grid leak or high resistance in a receiving set or resistance coupled amplifier makes a very small difference. Such an error in the reading of a voltmeter is, however, a different matter.

High resistance voltmeters are expensive because their resistance is made of wire properly insulated and of the proper alloy to have a zero change of resistance with temperature. Being made of such material, they will read accurately under all ordinary conditions. Such wire-wound resistances for several hundred volts usually contain several thousand feet of wire, and are consequently expensive to make.

In view of these facts a voltmeter made with a commercial resistance can rarely be relied upon to be accurate to better than 10

percent. In many cases the error will be greater. If such a combination is used it should at least be done with the knowledge of the possible errors and not with the expectation of securing a high grade and accurate high resistance voltmeter.

—John H. Miller, *Electrical Engineer,*
Jewell Electrical Inst. Co.

Keying Battery-Operated Transmitters

Batavia,
New York.

Editor, *QST*:

It has taken one and one half years to write this letter. That long ago 8AX installed a 1,000-volt Willard B battery for plate supply and since then key clicks have been a continual source of worry. Every method suggested in *QST* has been tried.

All plain inductance and condenser combinations show a condenser connected between positive and negative high voltage in all *QST* articles written so far. Everyone has been tried here and found to leave a click which can be heard on Radiola Superhet two floors below the transmitter. Turnbull's tube gridleak stops the click but prevents break-in work and is also too fickle to fool with. Huffman's keying circuit will break 500 volts o.k. but no combinations of resistances could be found here to break 1,000 volts without click.

By simply keying in the negative lead with a 4- μ f. condenser across the relay contacts and a 3-henry choke in the line, no click can be heard on a receiver tuned 3 meters off the working wave (with the receiver non-oscillating, of course) and with

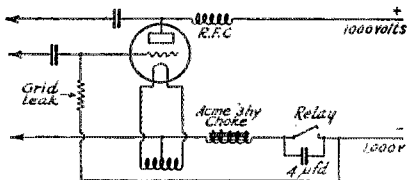

the transmitter and receiver not over four feet apart. There is no QRX for B.C. receivers here now. It is impossible to hear the set work when listening on a superheterodyne receiver 10 feet away when this same receiver will pick up a click everytime a lamp key socket is turned on anywhere in the house.

—E. C. Walker, *8AX*

It Is Real Work

2227 Lake Shore Avenue,
Los Angeles,
Cal.
December 29, 1926.

Editor, *QST*:

To some of us who are not quite so interested in traffic handling as some other phases of amateur radio it seems as if "Pse QSL" is the cry of the day. Being no longer directly engaged in operating either of the two A.R.R.L. Standard Frequency Stations (1XM and 9XL) I feel able to talk more freely than formerly.

Has it ever occurred to you (the gang, not the Editor) that a large amount of work is necessary to put out these schedules? Doesn't an OWLS—SF deserve a QSL even more than the average station, whether the DX be large or small? Many letters received when I was looking for a station for the Central States showed that amateurs think that once given a good wavemeter it's easy to run an S.F. station. Actually, *days* and *days* of preliminary work are necessary and every schedule must be operated by three or four men. Each station frequently checks from the other, from harmonics of WWV's schedules, and particularly from piezo crystals calibrated at both the Massachusetts Institute of Technology and the Bureau of Standards; occasional checkings are made by the OWLS Committee also. On my way west I spent *five days* working with the gang at 9XL, and when I left the work was not more than half done; that gives an idea of the preliminary work necessary to insure such a high degree of accuracy.

And why is all this work done? So that you and you, Messrs. Average Amateur (and other high frequency users) may have an accurate wavemeter. You don't even have to go outside the house, let alone paying good money for a calibration. Isn't a card or letter *every time you use these signals* a pretty cheap price to ask for all this work?

Sincerely,

—Killian V. R. Lansigh.

In charge, A.R.R.L. Standard Frequency Stations, Secretary, Alpha Sigma Delt Fraternity (radio).

No-Loss and Low-Loss

Headquarters Sixth Corps Area,
Office of Signal Officer,
1819 West Pershing Road,
Chicago, Ill.

Editor, *QST*:

I note in your December issue an article on "The Relative Importance of Losses in Radio Receiving Systems," by William W. Harper. It is, indeed, a pleasure to meet

through your columns men in this comparatively youthful industry who are not afraid to express opinions contrary to popular belief.

Unhappily, most of us are prone to write more or less for the glorification of our ideals and the display of our knowledge rather than for the education of our readers. The great Steinmetz said in his first volume, "All things pertaining to these works are simple if we analyze them as we go along", meaning that apparent knotty problems may be untangled if only one knot at a time is untied. Mr. Harper in his work is, apparently, undoing his knots one at a time.

It was very amusing during some of the recent radio shows to see people advertising "low-loss" and "no-loss" coils and condensers, while their competitors at the other end of the hall displayed signs which read "Low-Loss and No-Loss is Bunk". Obviously both were wrong but the public could not discriminate. Mr. Harper's article tends to clear up in the minds of the multitude misunderstandings which such signs and advertisements have created.

—C. B. Robinson, *Radio Engineer.*

Re: Handy's Handy Handbook for Hams

Omaha,
Nebraska.

Editor, *QST*:

The Hams' Handbook came today. It sure is FB, much more than was expected. Congratulations, OM. Any amateur who does not get one is outa luck. By the way please tell Mr. Hoover that I will be off the air for a while because I am going to read, read, read. The biggest buck's worth I ever got in radio.

—Herb Jones, 9DUH

Is It Fading?

Tippecanoe City,
Ohio.

Editor, *QST*:

All of us have noticed the peculiar characteristics of the short waves, and there has been much discussion in *QST* and elsewhere about the skip distance, reflection theories, effects of the sun, etc. These acute changes were more surprising to some of us old amateurs who had been so familiar with the long waves that the way the signals behaved on 40 meters was almost unbelievable.

Among these changes there is one which I have never heard mentioned. When listening a little below 40 meters in the evening we hear foreign amateurs sometimes loud and steady, sometimes fading very much like any other signals yet often seeming to

sound "hollow" as if the signals were reverberating from a cavity, sounding deep and muffled; in other words sounding as though they were coming from the other end of a large, hollow pipe.

Tuning up to the U. S. band I have noticed some very close stations have the same hollow sound, and upon investigation these stations have been found to be within a few hundred miles and operated with a lot of power, the low-power near-by stations being inaudible.

I am wondering if any of the other fellows have noticed this phenomena and if it has been accounted for?

—Kenneth Trost, 8BAD

Filing QSL Cards

Frankfort,
Michigan.

Editor, *QST*:

An invoice book, such as those kept by storekeepers, makes a good QSL card file. The cards can be pasted into the book the same as the invoices are. When so mounted they are always kept in neat order and are readily available for reference. These books sell for fifty cents and are a boon to the man who cannot paper the walls with his cards.

—George Collier, 8CYM

Please Note

106 Rushdale Road,
Meersbrook,
Sheffield,
England.

Editor, *QST*:

A well-known firm in this country recently published a letter headed "A Report From the A. R. R. L." and as this letter was from a member I wrote them. They replied that they were not aware that the report was not from Headquarters but only the opinion of a member of the League. As this mistake has been made before according to *QST*, I think members ought to put a note at the bottom of such letters making it clear that such letter is not from League Headquarters. This would stop a lot of misunderstanding on the part of both members and firms receiving such letters.

—Adolphus S. Williamson

Further Reports on the Aurora

269 Princess St.,
Kingston,
Ontario, Canada.

Dear Editor:

Starting on Oct. 19th I decided to make some notes on the aurora. That evening at 7 p.m. I noted the first rays of the aurora.

I immediately donned the phones. The 40-meter sigs were coming in fine and loud. However, as the rays increased in length and brilliancy, I noted that the sigs faded accordingly. Being near a window I was able to see the lights and to notice that when any extra strong bursts of lights occurred, the sigs faded away immediately. When the rays died down the 40-meter sigs came back again. WIZ, who is always readable here, was R1 and fading badly. No 40-meter sigs could be heard at all after the aurora got well started. Oct. 20 was even worse—no sigs at all, not even WIZ. The only station who broke thru was LP1 who was QRZ. Oct. 21st was nearly as bad as only three stations were logged here. On Oct. 22 signals started to come in again but still very QRZ. After 7 p.m. these all died a painful death until all was peaceful and quiet. On Oct. 23rd sigs again nearly normal but subject to lots of fading. The above observations were all taken on an oscillating detector and one step audio, the usual 3 circuit tuner and (I stress the following) old type Signal condensers of 5 and 11 plates.

Conclusion—The aurora has no effect here until after approximately 7 p. m. After that one might as well go to bed and forget the set. It's no use trying to listen for the sigs here when the aurora starts.

Daytime is all right. Sigs from both coasts roll in.

—V. Sharp, Canadian SVS.

Pipe Antennas

Lakeside Club,
Roosevelt,
Arizona.

Editor, QST:

More about the vertical pipe antenna—a very good one, and one that looks fairly well, can be built from steam condenser tubes,

either brass or copper. The tubes can be obtained at a very small cost from the local power company or anywhere else where steam is used. The tubes for steam work must be renewed regularly and the old ones junked. They can be jointed by sweating in a piece of brass or copper rod which just fits in the ends of the pipe and then filling the groove where the two ends come together with solder. This idea, as far as I know, comes from Mayfield of 6AZM. The antennas made from this tubing are quite rigid and present a neat appearance.

—F. F. Taylor, 6BJI

About Esperanto

c/o U. S. Postoffice,
Madison, Kansas,

Sro. Kenneth B. Warner,
Secretario de la American Radio
Relay League,
Hartford, Conn.

Tre estimata Sinjoro:

Preskau dekok monatoj pasighas de post kiam vi sciigis min ke la Ligo kune kun la samcelanaj ligoj de Europo, jam decidis alpreni Esperanton kiel dua au internacia lingvo por paralado trans la limoj internaciaj.*

De post tiu tempo, la amikoj de Esperanto estas kuraghigitaj de amikajhoj de kaj la Ligo de Nacioj kaj la poshtaj kaj telegrafaj asocioj de Europo.

Chio chi estas bonaj—sur papero—sed chu ia konstatebla progreso estas faranta de Esperanto kiel chiotage, praktika afero? Chu iuj radiaj amatoroj en Ameriko au Europo estas uzantaj la lingvon au lernantaj ghin?

Mi dankas vin.

Via por Radio kaj Esperanto.

—Elmer E. Haynes.

*The League has recommended Esperanto to its members who are interested in an international auxiliary language. See p. 40, September, 1924 QST.
—Editor.

Hey,
Am—
Have u ordered ur copy of
Andy's
Andy
Handbook?

THE BEST \$1 YOU EVER SPENT!

PUBLISHED BY
AMERICAN RADIO RELAY LEAGUE
1711 PARK ST. HARTFORD, CONN.



ALUMINUM is a NECESSITY in RADIO

TODAY the crowding of the air makes shielding essential. Radio has turned to Aluminum for shielding because its properties permit the effective elimination of many of the hazards to perfect reproduction. ¶By using Aluminum for top, base, sides and center interstage shield, the designer of the R. B. Lab. 2-tube Receiver has created an effective combination. The 3/32" sheet Aluminum Panel is a photographic reproduction of a rare piece of walnut. Hammariund-Roberts, Silver-Marshall, L. C. 27 and Varion A. C. specify Aluminum for shielding. ¶Alcoa Wing type Aluminum shields prevent interstage interference effectively and economically. Can-type Shields made of Aluminum are fully effective—individually protecting the various stages. ¶Alcoa Aluminum is effective due to its high durability and low electrical resistance. ¶Used for cabinets and panels Alcoa Aluminum is light, easily worked and is available in the most beautiful wood effects.

Here are some of the Applications:—

Alcoa Shields, Box Shields, Cabinets, Panels, Variable Condensers, High-purity Rods, Foil for Fixed Condensers, Die-Castings, Screw Machine Products.

ALUMINUM COMPANY of AMERICA, Pittsburgh, Pa.



ALUMINUM COMPANY OF AMERICA
Room 2324, Oliver Building, Pittsburgh, Pa.

Gentlemen:

Please send me a complimentary copy of the booklet checked on this coupon.

Name

Street

City State.....

Circuit I now use

Circuit I will build next

Check the square for one, or both, of the booklets you wish

Booklet
"Aluminum Radio
Shields"
A treatise by Cockaday and Free
on Radio Shielding

Booklet
"Aluminum for
Radio"
Describes the general application of
Aluminum to radio



YAXLEY

APPROVED RADIO PRODUCTS

Air-Cooled Rheostats

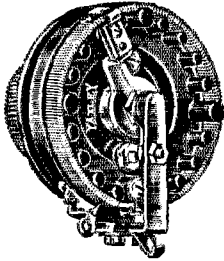

Designed and constructed to meet the requirements of modern radio. Very accurate and with an extremely fine adjustment that does away with the

necessity for vernier attachments. The many turns of wire provide long contact surface. The coil is air-cooled on all four sides which permits radiation. No steel is used in construction. Mounts in single 7/16" panel hole. Bakelite base. Made in 2, 3, 6, 10, 15, 20, 25, 30, 40, 60 and 100 Ohm capacity, each complete with Bakelite knob \$1.35

Special Switches

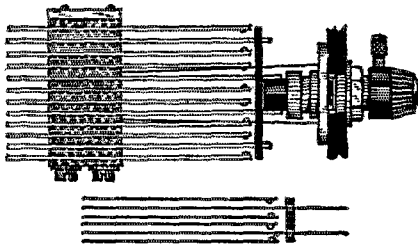

The Bracket Type Switch shown above is one of the many designed to meet practically every radio need. Can be had from a single pole, single throw switch with two springs to a four pole, double throw switch with twelve springs and all combinations in between. Either as a two position or three position switch, locking or non-locking. In writing give as much information as possible, together with sketch of spring arrangement wanted and thickness of panel.

At your dealer's. If he cannot supply you send his name with your order to

YAXLEY MFG. COMPANY
Dept. S, 9 So. Clinton Street
CHICAGO, ILL.

HALCO

DALLIN-HALCO SUPER

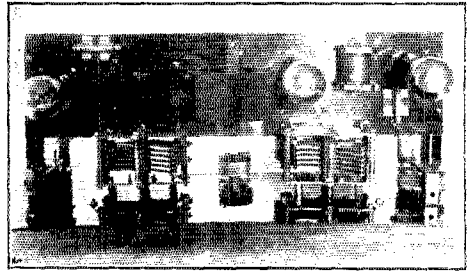

This is the extremely sensitive, easily operated short-wave receiving set designed by Edwin B. Dallin of Cruft Laboratory and described by him in January Q S T.

We have just received, from far away Baghdad, an order for a Dallin-Halco Super on which we know KDKA will be regularly heard on short-waves. We call this the Arabian Nights come true.

Price of complete kit, Dallin-Halco Super
(nothing else to buy).....\$47.00

Halco Mail Order Service
132 Hanover Street Boston, Mass.

LYNCH

METALLIZED

WARRANTED FIXED RESISTORS

THE vital importance of a silent, accurate resistor cannot be over-estimated. Comprising a concentrated metallized deposit one-thousandth of an inch thick, upon a glass core and sealed forever within the tube, each Lynch Resistor is warranted absolutely noiseless, permanently accurate, dependable! Guaranteed accuracy—10%; in production they average 5%. .25; .5; 1; 2; 3; 4; 5; 6; 7; 8; 9; 10 Meg., 50c. .025; .09; .1 Meg., 75c. Single mounting 35c; Double, 50c. If your dealer cannot supply you, send stamps, check or money order. We ship postpaid same day order is received.

Dealers—Get on our mailing list; we keep you posted on new developments. Write us today!

ARTHUR H. LYNCH, INC. **RMA** 426 Q
250 W. 57th St. New York, N.Y.

Why is the Karas Equamatic the most efficient receiver ever designed? Write us for full information.
KARAS ELECTRIC CO.,
1031 Association Bldg., CHICAGO

Faradon

There's a Faradon for Every Filtering Need

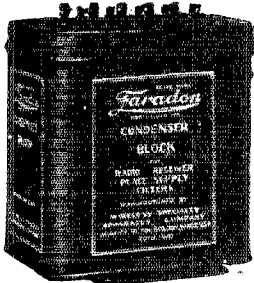

Model WS-3750 Filter Capacitor Block; conveniently tapped at 1, 4, 4 and 2 Mfds. Outside dimensions of casing are 3 1/4" x 4 1/2" x 5" (high). Price each \$10.50.

Here's the filter condenser that will iron out that 60 cycle A. C. power line hum to perfection. It's the Faradon Filter Capacitor Block of 14.2 Mfds., the block that meets the requirements of the usual receiving set "B" eliminator circuit. It's constructed to operate under higher voltages than are usually required. You'll find the Faradon Block unsurpassed for convenience, safety and dependability.

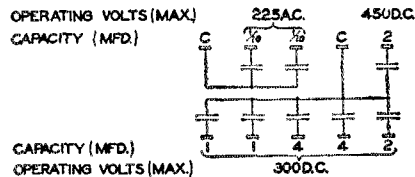

And for that D. C. "B" Eliminator

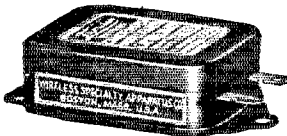

Model WS By-Pass Unit Made in 1/2, 1 and 2 MFD Capacitor

You'll find that Faradon By-Pass and Filter Units fulfill every requirement for uniform performance, high factors of safety and lasting dependability. It pays to insist upon Faradon.



Model WS Filter Unit

Wireless Specialty Apparatus Company

Jamaica Plain, Boston, Mass., U. S. A.

630

HAMS!! DON'T PASS THIS UP

"THE BUY OF A LIFE-TIME"

WE HAVE JUST PURCHASED FROM THE U. S. NAVY
THESE TRANSMITTING TUBES—ALL IN NAVY SEALED BOXES

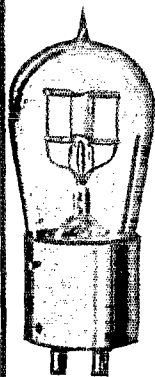

NAVY TYPE CG-1162 5 WATTS PLIOTRONS

(MFD BY GENERAL ELECTRIC CO.)
NEW, IN ORIGINAL CARTONS

Filament Voltage $7\frac{1}{2}$ Volts.
Filament Current $1\frac{1}{4}$ Amps.
Safe Plate Voltage 550 Volts.
Plate Current 40 Milli-amps.

Also Used as Power Amplifying Tube

STANDARD BASE

PRICE ONLY \$1.⁰⁰
EACH

NAVY 250-WATT 1000-2000 Volt-Plate 32 Volt-Filament



ALL BRAND NEW—GUARANTEED TO OSCILLATE
MFGD. BY DE FOREST

PRICE ONLY \$10.⁹⁵

5000 VOLT DUBILIER-002-BY- \$1.⁰⁰
PASS CONDENSERS

MADE FOR U. S. SIGNAL CORPS

No C.O.D.—No Parcel Post Shipments. Send in your name for our Ham List.
References—Dun or Bradstreet, Federal Trust Co, Newark, N. J.

THE NEW JERSEY RADIO SUPPLY COMPANY
76 SPRINGFIELD AVE. NEWARK, N. J.



ENAMELED ANTENNA



Best outdoor antenna you can buy.
7 strands of enameled copper wire;
maximum surface for reception.
Prevents corrosion and consequent
weak signals.

The Original Celatsite

—a tinned, copper bus bar wire with non-
inflammable "spaghetti" covering, for
hook-ups. 5 colors; 30 inch lengths.

We also offer the highest grade of "spa-
ghetti" tubing for Nos. 10 to 18 wires.
5 colors; 30-inch lengths.

Send for Complete Folder
of Acme Wire Products

ACME WIRE CO., DEPT. S, NEW HAVEN, CONN.



ACME WIRE

MAKES BETTER RADIO

It helped to win WORLD'S FOREIGN RECEPTION RECORD

Robert Davies writes:

"I used Model N, X-L Vario Denser on my
4 tube, home made set when I received my
six foreign stations besides QUE, Sidney,
Australia, 9000 miles away, and IRC,
Rome, Italy. I have used several condensers
but an X-L tops
them all."

This Is It

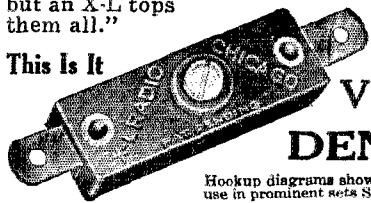

X-L
VARIO
DENSER

Hookup diagrams showing methods of
use in prominent sets SENT FREE.

X-L RADIO LABORATORIES
2428 N. Lincoln Avenue Chicago, Ill.

THE RUBEN DIRECT RADIO CONTROLLED RELAY

NOW AVAILABLE TO AMATEURS

For CALL SIGNAL and REMOTE CONTROL Work

A SIMPLE VACUUM TUBE RELAY WHICH OFFERS AN UNUSUAL OPPORTUNITY FOR DEVELOPMENT IN THE FIELD OF RADIO DYNAMICS. DIRECTLY CONTROLS A LOCAL CIRCUIT, NO OTHER OR AUXILIARY RELAY BEING REQUIRED. OPERABLE BY ALTERNATING OR DIRECT CURRENT OR BATTERIES. TUNABLE TO ANY FREQUENCY RADIO OR AUDIO. USABLE IN STANDARD APPLIANCES OR CIRCUITS INDEPENDENTLY, OR AS CALL SIGNAL RELAY AND DETECTOR, RADIO OR AUDIO AMPLIFIER.

PRICE \$8.50 MAILED C. O. D. OR SEND
REMITTANCE TO

ELECTRON RELAY COMPANY
(Licensees under Patents and Patents Pending to Samuel Ruben)
83 Fourth Avenue New York, N. Y.

Write for Complete Description

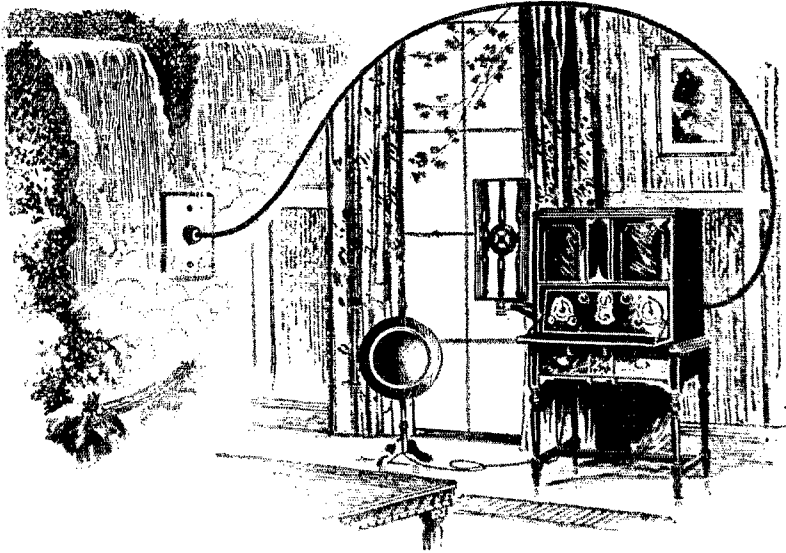

Unvarying *Beauty of tone,* through **Socket-Power Operation**

All the glorious melody and harmony awaiting release in every Stromberg-Carlson, is continually yours with Stromberg-Carlson electric supply equipment.

It is like having brand new batteries every time you turn on your Receiver. For Stromberg-Carlson socket-power units deliver a current supply which is at all times up to full efficiency and give more convenient, more economical and more uniform operation than any other form of power supply.

To insure these results Stromberg-Carlson electric supply equipment was designed solely to get the best operation and reproduction from Stromberg-Carlsons. No compromise was attempted to meet the requirements of other receivers.

Every Stromberg-Carlson model is designed to operate from house lighting equipment. Console models and the tables for "Treasure Chest" Receivers are proportionated to contain and conceal every device necessary to operate either type of set.

Stromberg-Carlson Telephone Mfg. Co
Rochester, N. Y.

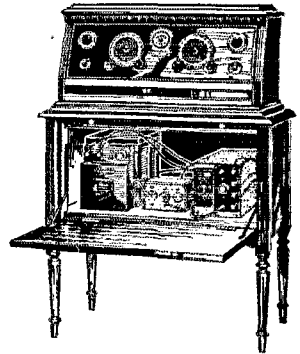

No. 501 Receiver, Treasure Chest, 5-tube; coils shielded; operates off either house current or batteries.
Price less accessories.....\$120.00
51 Radio Cabinet Table..... 54.50
Complete power supply equipment as shown in cabinet table above. Left to right:
"A" Socket-Power Unit (Gould Unpower).....\$38.00
No. 301 Power-Switching Relay.....11.00
No. 401 "B" Socket-Power Unit with rectron tube.....\$64.00

Stromberg-Carlson

Makers of voice transmission and voice reception apparatus for more than 30 years

SEND COUPON BELOW
FOR FREE BOOKLET

SAVE \$45⁰⁰



R. L. Duncan,
Director, R. I. A.

I AM cutting
the price of
our radio
course to the
bone because
I need 800
more students
this month to
fill the big demands for
trained radio men.

As fast as we can supply graduates the shipping companies are snapping them up as radio operators to travel to the far corners of the earth. Other branches of radio are insistently clamoring for more trained men to fill responsible, well-paying positions on shore. So I am making this drastic reduction in the cost of our Home Study Course to radio amateurs only to induce more young men to make radio their life career.

Pass U. S. Government Radio
License Examination

This course eliminates the elementary phases of radio with which most amateurs are familiar. It carries you right through the more advanced radio operating technique and teaches Commercial procedure thoroughly. It qualifies you to pass your U. S. Government First Class Commercial License Examination.

Study at Home—Send Coupon

Moreover you can study at home—without giving up your present occupation. Radio Institute of America is the world's oldest radio school. The instruction is the finest obtainable anywhere. To be sure of getting the benefit of this special course send for booklet A-3. Just fill in the coupon below. It costs you nothing to receive this 40-page booklet chock-full of information.

RADIO INSTITUTE OF AMERICA

Formerly Marconi Institute Established in 1909
326-A Broadway New York City

CUT HERE

RADIO INSTITUTE OF AMERICA B
326-A Broadway, New York City

Please send me your special booklet A-3 with full information about the reduced price of your radio course for amateurs.

Name

Address

World's Finest Radio **BUG**
Improved Martin

Reg. Trade Marks
Vibroplex
Bug
Lightning Bug

VIBROPLEX
Trade Mark Reg. U. S. Pat. Off.

For Continental,
Morse or
Navy
Codes

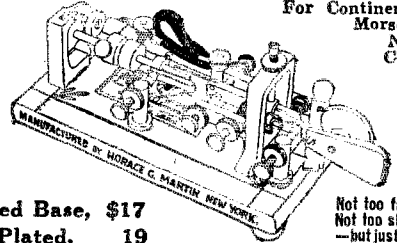

Japanned Base, \$17
Nickel-Plated, 19

Not too fast—
Not too slow—
—but just right

Get This **BUG** Now!

Now is the time to get your **BUG**. Be up-to-date—enjoy the many advantages of sending with this Improved **BUG**. You'll be amazed to find how easy it is to learn and to operate. Nothing can compare with this **BUG** in **EASE** and **PERFECTION** of sending. Over 100,000 users. Saves the arm, prevents cramp and enables the "ham" to send with the skill of an expert.

Special Radio Model

Equipped with extra large specially constructed contact points to break high current without use of relay. Not too fast—not too slow—but just right. Sent anywhere on receipt of price. **\$25**
Money order or registered mail.

THE VIBROPLEX CO., Inc.
825 BROADWAY NEW YORK

FOR EVERY BEGINNER

THE SIGNAL
PRACTICE SET

Complete in every detail with high grade key, true tone adjustable high pitch buzzer and brass code plate. R68 \$3.40



SIGNAL WIRELESS KEYS

Strongly made with coin silver contacts. Brass parts polished and lacquered. Very reliable units.
R48 1/4 in. K.W. \$2.80 R62-3/4 in. contact \$2.50
R55-3/4 in. \$3.70
R64-1/2 in. \$3.90



Signal Buzzer



Small neat high frequency type. Has standard resistance of 2 ohms. Black crystallized lacquer finish. Special resistances on quality orders. R80 \$1.25

We manufacture a complete line of telegraph instruments.
SIGNAL ELECTRIC MFG. CO., Menominee, Mich.

QST Oscillating Crystals

NEW LOW PRICES Effective January 1st, 1927

We will grind a crystal for power use for use in the 80 meter band for \$25.00. With this crystal we give its frequency accurate to better than a tenth of 1%.
For use in the 150-170 Meter band \$15.00. Frequency stated accurate to better than a tenth of 1%.

Attention Owners of Broadcasting Stations

We will grind you a crystal, ground to your assigned frequency accurate to better than a tenth of 1% for \$50.00. This crystal is so ground so as to be capable for use in POWER circuits, besides being excellent for use as a frequency standard. Crystals ground to any frequency between 50 and 10,000 Kcs. Let us quote on your requirements.

SCIENTIFIC RADIO SERVICE

The Crystal Specialists

Box 86, Dept. G Mount Rainier, Md.



Transmitting Tube Sockets



REL has answered the call of all Hams. We now have those transmitting tube sockets that you thought were never to be found. **HIGHEST QUALITY**

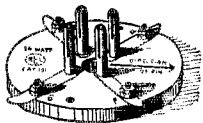

To be used with RCA 203-203A, WE211D, UV217 and all other standard 50 Watt tubes. Low loss, sure grip, ideal for S.W. operation.

Catalogue...131 Price...\$2.00

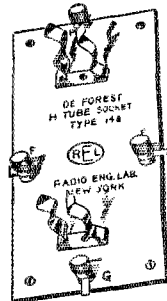

To be used with De Forest H tube or De Forest HR rectifier tube. An ideal socket for the ultra S.W. tube.

Catalogue...148 Price...\$2.00

250 Watt tube End Mountings to be used with either De Forest "P" or RCA UV-204A tubes.

Catalogue...128

Price...\$4.00 per pair

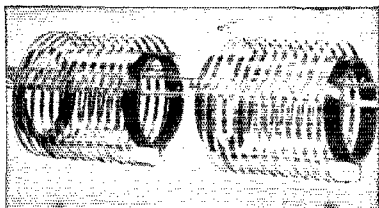

REL Transmitting Inductances are Flatwise Wound on Glass. Designed for Short Wave C. W. Transmission. The inductances you will eventually use.

Type L—(40, 80, 150 meter wave lengths)

Type S—(20 meters and less)

Single Unit, either type with three clips...\$5.50

Double Unit, either type with six clips and two glass coupling rods.....\$11.00

REL Low Wave Plug-in Coils—The Pioneer in their field Unit consists of five coils, plugs and mounting. Wave length range 10-110 meters. Adaptable to all modern circuits. Inexpensively priced at \$4.50.

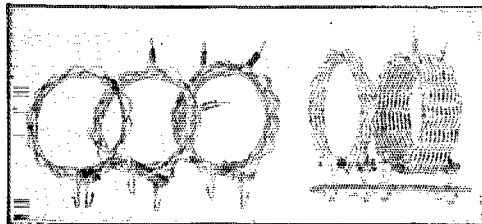

HAVE YOU GOTTEN YOUR CATALOGUE?

If not, get it now. It's chock full of the information that every Ham should have in his kit. Tuned Grid, Master Oscillator, Crystal Control—Just a few of the subjects that are comprehensively covered in this handy handbook of Short Wave Apparatus. Send today. U. S. currency or P. O. money order.



REL Owns and Operates Experimental Station 2XV on 15.1 Meters, 19867 Kilocycles, Crystal Controlled.



Radio Engineering Laboratories

27 Thames Street, N. Y., N. Y.

90 VOLT "B" POWER UNIT \$12.75

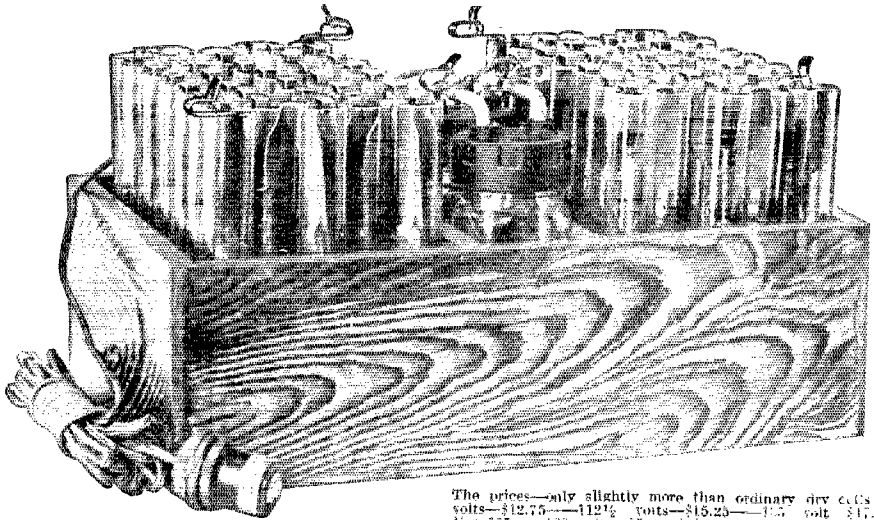

RUMOR has had it this **NEW HAWLEY ADVANCED POWER UNIT** was coming—and here it is. Hawley Storage "B" batteries have been standard for over 5 years and the same quality—the same standard of workmanship comprise this unit with its new ingenious hook-up and built-in-charger giving the utmost in B-Eliminator simplicity. Positively guaranteed not to give the slightest tinct or trace of a hum or line noises. Simply plug it into your electric socket—and forget it. Any inexperienced person can hook it up in 2 minutes, as all voltages including those for any kind of detector are all plainly marked. Operates any 1 to 10 tube set. Does not contain any acid. It's so good—such true smashing value—that my 5 year old 20 day trial offer refund applies. You've got to see it—hear its operation to fully appreciate this statement.

The prices—only slightly more than ordinary dry cells 90 volts—\$12.75—112½ volts—\$15.25—125 volt \$17.50. For 105 to 120 volts, 25 to 150 cycle alternating current only. Special sizes to order of any voltage. Knockdown kits at still greater savings. All complete as above—mounting to purchase extra. Further covered in my regular 2 year guaranteed. Ample stock—all packed—same day shipments and your order is all I need to speed it on its way to you. Simply say—no C.O.D.—day expressman its cost plus small transportation charges—and you'll thank me later—or write for my free literature, testimonials, etc.

B. HAWLEY SMITH,

324 Washington Ave., Danbury, Conn.

U. S. A., Mfr. of—"A" Power Units, "B" Power Units, "A" Storage Batteries, "B" Storage Batteries and A & B Chargers including Trickleers.

FERRANTI AUDIO FREQUENCY TRANSFORMERS FOR ANY CIRCUIT

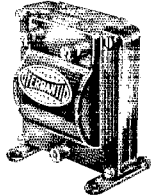

Ferranti Transformers stand supreme in that they pass on to the loud speaker an uncensored message. All the notes... bass notes and treble notes... are there.

FERRANTI, Inc.

130 West 42nd St., New York, N.Y.

FERRANTI, LTD,
Hollinwood, England

FERRANTI ELECT., LTD
26 Noble St., Toronto Canada

Bradleystat PERFECT FILAMENT CONTROL

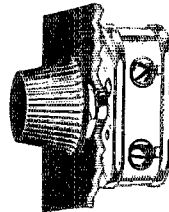

Provides complete noiseless filament control for all radio tubes without change of connections. Metal parts are nickel plated. One hole mounting. Self contained switch opens battery circuit when desired.

Allen-Bradley Co.

Electric Controlling Apparatus
277 Greenfield Avenue
Milwaukee, Wis.

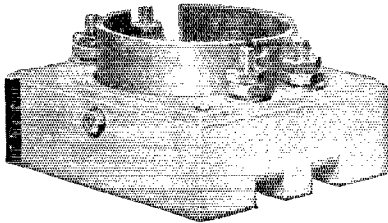

50 Watt Lowloss Socket

Maple-treated base with brass airgap shell and heavy phosphor bronze springs. For UV 203A and similar tubes.

Price \$1.25



UC 1015 Condenser

Advantages:

1. 7500 volts tested.
2. Mica insulated.
3. Eleven capacities, .0002 to .001 mfd.

Price \$1.25

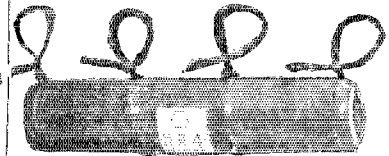

15,000 ohm Gridleak

Tapped at 5000 and 10,000 ohms with 85 watt capacity.

Price \$1.50

5000 ohm size, no taps \$1.00

UTILITY RADIO CO.,

80 LESLIE STREET,

EAST ORANGE, N. J.

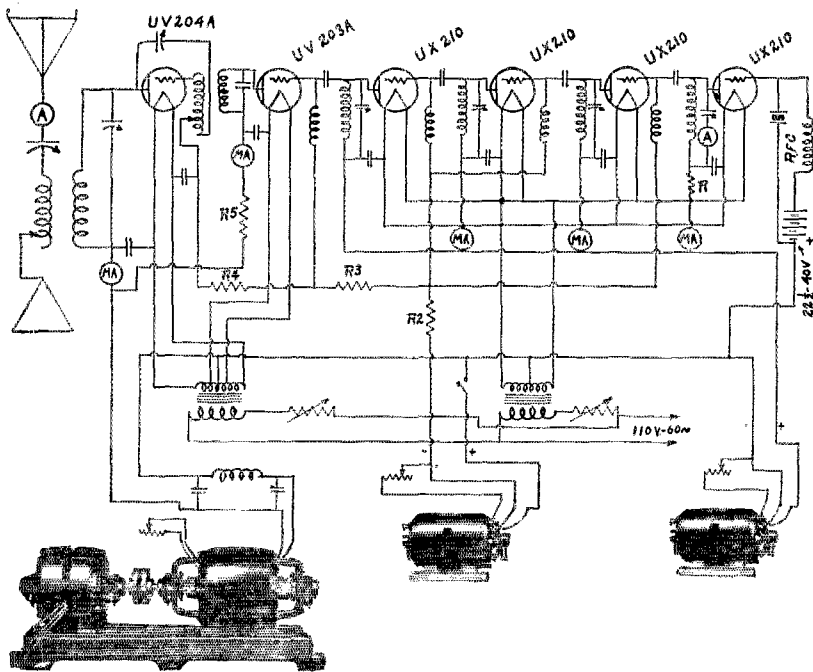

THIS is the fifth of a series of five "hook-ups" for crystal control transmitters using "ESCO" Maximum miles per watt Power Supply

This set requires a UX210 oscillator, three UX210 frequency doublers of the UX210 type, a 203-A power amplifier and a 204-A power amplifier. The crystal is a 320 meter one for 40 meter operation or a 160 for 20 meter work. Filament supply comes from two filament transformers, one for the 210s and another tapped for 11 and 13 volts for the 203-A and 204-A tubes. Plate supply for the 210s is obtained from Item 8, a resistance in the plate circuit of the oscillator tube producing the necessary IR drop to supply the tube with only 300 volts. Plate supply for the 203-A and 204-A tubes is obtained from Item 22, resistance R5 supplying the drop, allowing 1000 volts to be used on the 203-A. Grid bias for the tubes is obtained from Item 4 with IR drop resistances in those circuits requiring less than 400 volts. The grid bias for the oscillator tube comes from a block of B battery.

ELECTRIC SPECIALTY COMPANY

TRADE "ESCO" MARK

225 South Street

Stamford, Conn., U. S. A.

Manufacturers of Motors, Generators, Motor-Generators,
Dynamotors and Rotary Converters for Radio and other purposes

ELECTRAD

Use ELECTRAD Certified Condensers

Without hesitancy we claim the Electrad Certified Six Point Pivoted Condenser to be without equal. Here is why: Uniform pressure insured by rigid binding at six points. Sheet copper, not tin-foil. Soldering iron can't hurt it. Certified electrically and mechanically. Guaranteed to remain within 10% of calibration. Standard capacities. All types. Prices U. S. 30c to 75c, Canada 45c to \$1.50, in sealed dustproof packages at all good radio stores.

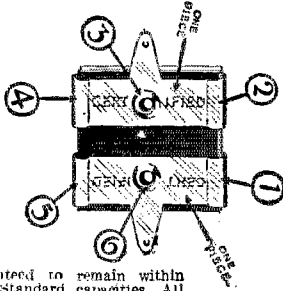

ELECTRAD Certified By-Pass Condensers

Prevents B-voltage fluctuation. Gives undistorted amplification. Each condenser certified electrically and mechanically. Tested at 1000 volts. Maximum working voltage 250 A.C. Has low power factor, low radio-frequency resistance and negligible D.C. leakage. Don't take substitutes. Get the Electrad Certified. If your dealer can't supply you, let us know. Prices U. S. 60c and \$1.75. Canada 85c to \$3.25.

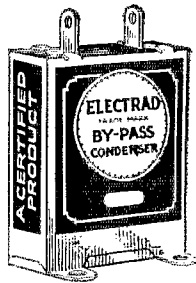

The Choice of Radio Engineers!

ELECTRAD Royalty Variable High Resistances

The remarkable results secured by the use of these perfected resistances are due to the fact that they control the output without any distortion or noise, so that pure music is received through the loud speaker. Note these six important features of design and construction:

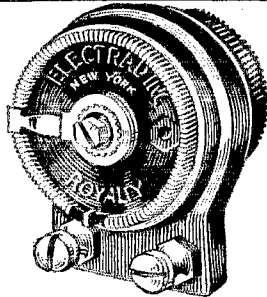

Exclusively licensed by Technivox Corporation July 27, 1926.

- 1—Resistance element is not exposed to any mechanical operation.
- 2—Electrical contact is made positive by a metallic arm on the wire-wound strip.
- 3—The same resistance is always obtained at the same point.
- 4—The resistance value is under control in the process of manufacture and does not change in use.
- 5—The entire range of resistance is covered with less than a single turn of the knob.
- 6—There is no mechanical binding and the shaft is turned over the entire range with a perfectly smooth operation.

Made in various types for various purposes. Prices \$1.50 to \$2.00; in Canada, \$2.10 to \$3.00. Write for circular.

For perfect control of tone and volume use the Electrad 500,000-ohm compensator. For free hookup write 175 Varick Street, New York City.

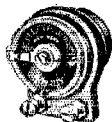

ELECTRAD

How to use Resistance in Radio!

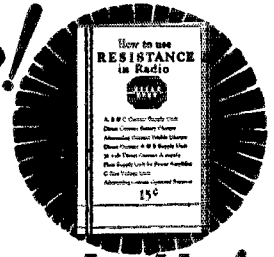

Send for this new booklet!

Ward Leonard Electric Company announces a booklet of interest to radio dealers, experimenters, and engineers.

Resistance assumes major importance in radio as higher voltages and currents are employed in power supply units.

"How to Use Resistance in Radio" tells the proper use of resistance and outlines many of the new A.C. and D.C. power circuits. It will be sent postpaid for 15c.

Ward Leonard Electric Company
MOUNT VERNON, NEW YORK, N. Y.

Resistor specialists for more than 35 years.

7135-3

Special QST Back-Copy Offer

1 set—1925 copies (except Jan.) with index and

1—set 1926 copies (complete) with index and

Two regular \$1.50 QST binders

All for \$4.00

A Saving of \$4.00

Above sets of back-copies without binders for \$3.00
QST, 1711 Park St., Hartford, Conn.

A NEW Amplifier Unit

that Provides for Extremely Faithful Reproduction

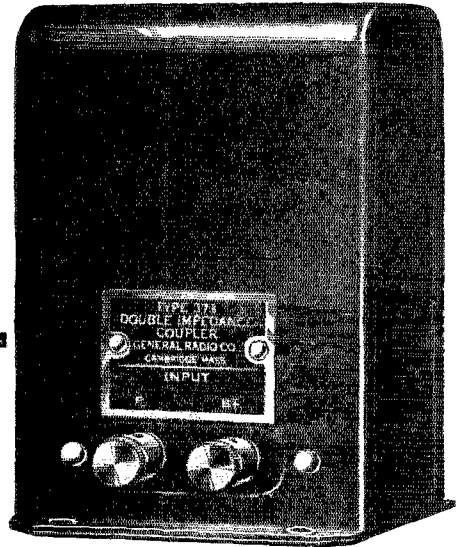
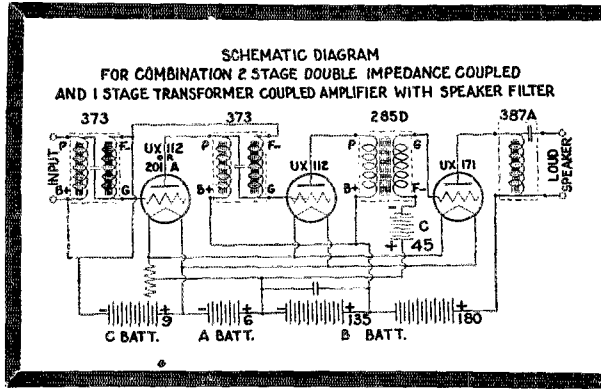

While the use of double impedances is not new in principle the General Radio Type 373 Double Impedance Coupler is unique in design and performance. To facilitate installation the complete unit, consisting of two impedances and a fixed condenser, is contained within a metal shell. It is connected in precisely the same manner in an audio amplifier circuit as a transformer.

The extent of its range of even amplification is from appreciably below 100 cycles to over 10,000 cycles, with a gradual downward deviation of slightly less than 7% between 100 and 400 cycles. This deviation in an otherwise perfect amplification curve is so slight as to be practically negligible, because the ear of the average individual can not detect a variation of intensity of much less than 25%.

The amplification curve, in fact compares favorably with that generally obtained with resistance coupled systems which have the disadvantage of large sacrifices of plate voltages.

The General Radio Double Impedance Couplers have the further advantage that when connected as shown in the above diagram, with one transformer coupled stage, they may be used with a properly designed Plate Supply Unit.

Type 373 Double Impedance Coupler.....\$6.50

The following parts are used in the General Radio Laboratory Amplifier:

- 2—Type 373 Double Impedance Couplers.....\$13.00
- 1—Type 285-D Audio Transformer..... 6.00
- 1—Type 387-A Speaker Filter..... 6.00
- 3—Type 349 UX or CX Sockets..... 1.50
- 1—Type 410 or 301 Rheostat, 6 ohms..... 1.50

Complete cost of amplifier parts.....\$27.75

If your dealer is unable to supply you with any of the above items we shall be glad to send them to you prepaid upon receipt of list price.

GENERAL RADIO CO.,

CAMBRIDGE, MASS.

GENERAL RADIO

ARRL MEMBERS ATTENTION! You are not all located within shopping distance of a dealer stocking G. R. parts. Remember that we will deliver, postpaid, anywhere in United States any of our radio parts on receipt of current catalog price. Also we welcome your correspondence. Have you Bulletin 926 in your files? If not a postcard will bring it.

HAMMARLUND Precision PRODUCTS

Are Officially Specified for These Fourteen Popular New Circuits

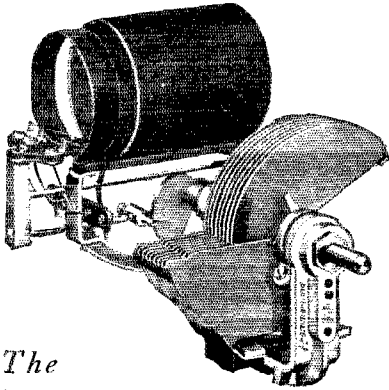

The "AUTO-COUPLE"

A scientific assembly of Space-Wound Coil, "Midline" Condenser and Aluminum Shield, giving automatic, graduated primary coupling at every condenser setting and insuring maximum transfer of energy at each wavelength. Officially specified for use in the new Hammarlund-Roberts "Hi-Q" Receiver, but equally efficient in any other receiver of similar characteristics.

COCKADAY "LC27"
LOFTIN & WHITE
ST. JAMES SUPER
LACAULT "LR4"
MORRISON "VARION"
SARGENT "INFRADYNE"
POPULAR SCIENCE
MONTHLY "POWERFUL"

BROWNING-DRAKE
VICTOREEN SUPER
PACENT "ULTIMAX"
NEW HARKNESS
HENRY-LYFORD
CARBORUNDUM SUPER
HAMMARLUND-ROBERTS
"HI-Q"

Most good radio stores sell Hammarlund-Precision Products—if yours doesn't, write us direct.

HAMMARLUND MANUFACTURING CO.

424-438 W. 33rd Street, New York

For Better Radio
Hammarlund
PRECISION
PRODUCTS



anniversary sale!

TRANSMITTING APPARATUS

INDUCTANCES	
ARSCO NO-LOSS Pancake—20—40 meters	34.49
ARSCO NO-LOSS Pancake—40—200 meters	4.89
R.E.L. Single Inductance	4.89
R.E.L. Double with coup. vods.	9.89

CONDENSERS	
CARDWELL .00022 mfd. 3000 volt transmitting condenser	3.29
CARDWELL .00044 mfd. 3000 volt	5.89
HAMMARLUND .00044 mfd. 3000 volt	8.79
NATIONAL .00015 mfd. 6000 volt	10.89
NATIONAL .00025 mfd. 3000 volt	8.98

FILTER CONDENSERS	
SANGAMO—1 mfd. 1000 volt	1.49
SANGAMO—2 mfd. 1000 volt	2.19
SANGAMO—4 mfd. 1000 volt	3.69
ACME—2 mfd. 750 volt	2.19
ACME—2 mfd. 2000 volt	6.19
PARADON—1 mfd. 1750 volt	2.29

TRANSFORMERS	
THORNDARSON COMBINATION TRANSFORMER 7 1/2 WATT SET	6.29
THORNDARSON 80 Watt P.L. for 50s	6.19
THORNDARSON 150 Watt P.L. for 50s	8.89
THORNDARSON 300 Watt P.L. for 250s	13.59
THORNDARSON 300 Watt Plate for 5s	11.59
THORNDARSON 450 Watt Plate for 50s	16.29
THORNDARSON 900 Watt Plate for 250s	27.29
ACME 75 Watt Power	13.59
ACME 200 Watt Power	18.29
ACME 500 Watt Power	23.29
ACME 500 Watt Power	30.89

GRID LEAKS	
Ward Leonard New—Centertapped—for 250 Watt Sets	2.49
Ward Leonard for 5 and 50 Watt Sets Centertapped	1.89
General Electric for 5 and 50 Watt Sets	1.59
Crescent Lavite—non inductive	2.19

METERS	
JEWELL—3" flush mounting type A.C. or D.C. 0-7 10-15 etc	6.39
JEWELL—3" flush milliameters 0-10 10-25 50-100 100-300 500-1000	6.39
JEWELL—3" flush thermo couple antenna ammeter 0-15 1-15 2-25 3-45	9.89
ROLLER SMITH—H. W. A. 0-1	4.49
ROLLER SMITH—H. W. A. 0-2.5	3.89
Weston Meters at Reduced Prices.	

FOR THAT NEW S. W. RECEIVER Short Wave Receiving Specials	
AERO Short Wave Kit	9.80
R.E.L. Short Wave Kit	4.19
General Radio .000125	2.49
General Radio .00025	3.50
HAMMARLUND .00015	3.79
HAMMARLUND .00025	3.59
NATIONAL with dials .00015	4.49
NATIONAL with dials .00025	5.49
R. P. Choke	7.90
Grid Leaks—all sizes	2.90
Marco Verrier Dials	1.49
Pilot Verrier Dials	.89c
Federal Single Ckt Jack	2.90
Benjamin Sockets	.60c
Precise Audio Trans	2.59
1 Hole Mount Rheostat	.60c
Fixed Sangamo Condensers	1.10

24 HOUR MAIL ORDER SERVICE

send for our list of other bargains!!!
amateur radio specialty co.
77 cortlandt street new york ny

GOODS SOLD ON MONEY BACK GUARANTEE

DUDLO

MAGNET WIRE AND WINDINGS

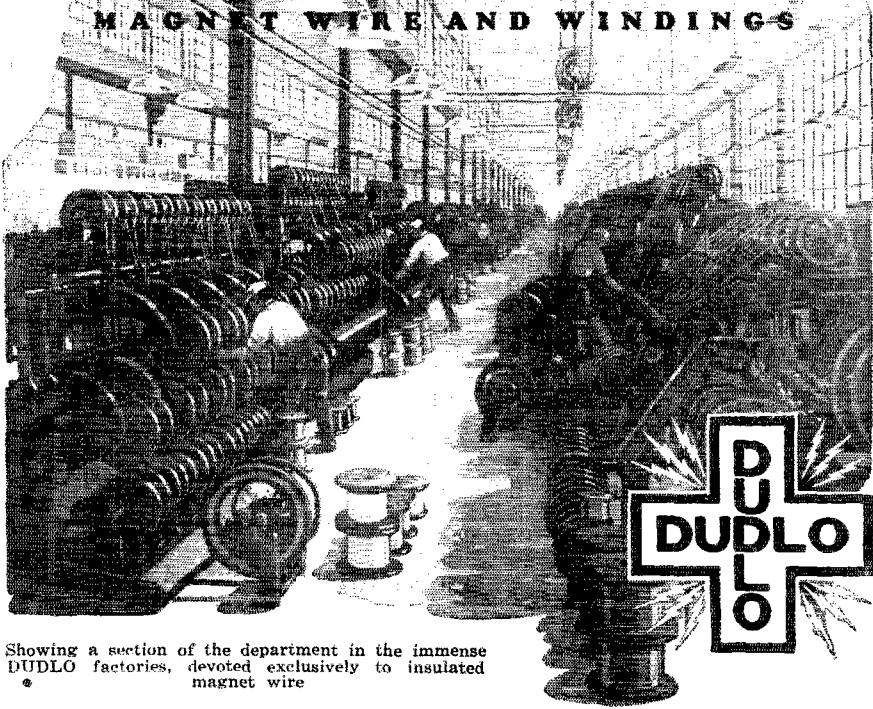

Showing a section of the department in the immense DUDLO factories, devoted exclusively to insulated magnet wire

UNIFORM and DEPENDABLE INSULATION

Creates a Preference for Dudlo Magnet Wire

Copper wire accurately drawn to gauge from pure copper rod of maximum conductivity is scientifically annealed before being insulated.

A smooth even coating of the finest grade enamel gives the greatest di-electric strength to the smallest possible diameter.

A wrapping of cotton or silk of the highest quality, is wound tightly and closely to insure the most perfect insulation.

Strict adherence to diameter is important. Where Dudlo Magnet Wire is used your winding will agree with your calculations.

Specify Dudlo Wire and be certain of the best quality of copper rod, and the finest grades of insulating material, uniformly and compactly wound.

DUDLO MANUFACTURING CORPORATION, FORT WAYNE, INDIANA.

412 Chamber of Commerce Bldg., 160 North La Salle Street 4153 Bingham Ave.
NEWARK, N. J. CHICAGO, ILL. ST. LOUIS, MO.

274 Brannan St.
SAN FRANCISCO, CALIFORNIA

SAY YOU SAW IT IN Q S T—IT IDENTIFIES YOU AND HELPS Q S T

SANGAMO

Mica Condensers in intermediate sizes



IMPROVE
TONE
RANGE
AND
VOLUME

IT is accuracy, not luck, that makes one receiver sweeter and more powerful than another that is almost its twin. Especially condenser accuracy, for the closer you come to absolute accuracy at these critical parts, the more wonderful your receiver will be. The cost of accurate condensers is small—the effect is immense.

Now you can get Sangamo Mica Condensers in capacities in between the usual stock sizes so you can build with greater accuracy than ever before. They are guaranteed to be accurate, and they always stay accurate, being solidly molded in bakelite. Neither heat, cold, moisture, pressure nor acid fumes will affect their capacity, because bakelite seals the delicate parts against all outside influences.

Capacities in microfarads and prices

0.00004	} 40c.	0.001	} 50c.	
0.00005		0.0012		
0.00006		0.0015		
0.00007		0.00175		
0.00008		0.002		
0.0001		0.0025		
0.00012		0.003		} 60c.
0.00015		0.0035		
0.000175		0.004		} 70c.
0.0002		0.005		
0.00025	0.006			
0.0003	0.007			
0.00035	0.0075			
0.0004	0.008			
0.0005	0.01			
0.0006	0.012			
0.0007	0.015			
0.0008	0.015	1.25		

With Resistor clips, 10c. extra

Also Sangamo By-Pass Condensers

1/10 mfd.	80c.	1/2 mfd.	90c.
1/4 mfd.	80c.	1 mfd.	\$1.25

Sangamo Electric Company
Springfield, Illinois

RADIO DIVISION, 50 Church Street, New York

SALES OFFICES—PRINCIPAL CITIES

For Canada—Sangamo Electric Co. of Canada, Ltd., Toronto.
For Europe—British Sangamo Co., Ponders End, Middlesex, Eng.
For Far East—Ashida Engineering Co., Osaka, Japan

Have You Tried the New
TYPE "G"

The Tube
of
Longer
Life

When used in all audio sockets, except last or output, of such receivers will surprise and delight the user with their clear reproduction and increased volume. "ECCO" Type "G" tube will carry more power without overloading than any other available High Mu. Average voltage amplification 20—Average Output Impedance 25,000.

PRICE
\$2.50

A Type
for Every
Radio Need

Makes a Good Receiver Better
Write for Complete Data Sheet
C. E. MFG. CO. Inc. . . . PROVIDENCE . R. I.

QUALITY PRODUCTS FOR CRITICAL AMATEURS

TECO SHORT-WAVE TRANSMITTER

By a change in the construction, this transmitter no longer uses two sockets in parallel, but instead a special filament rheostat gives the operator complete control of the output. Built with quality parts throughout and eminently adapted to the needs of the amateur.

SPECIAL \$39.50

IN HANDSOME MAHOGANY CABINET WITH DOORS, \$45

TECO CRYSTAL-CONTROLLED TRANSMITTER

A precision transmitter, complete with quartz crystal. A pilot lamp on the front of the panel acts as a wave-meter. Also equipped with radiation meter and vernier dials. Filter condensers and chokes designed to stand 2000 volts. Complete specifications on request.

SPECIAL PRICE, \$37.50.

Write for Information on Teco S. W. Receiver and Plug-in Coils

TRANSMITTING EQUIPMENT CO.
19 STUART ST., BOSTON, MASS.

The MERSHON Condensers

smooth out tone through B eliminators as a plane smooths the rough surface of a board

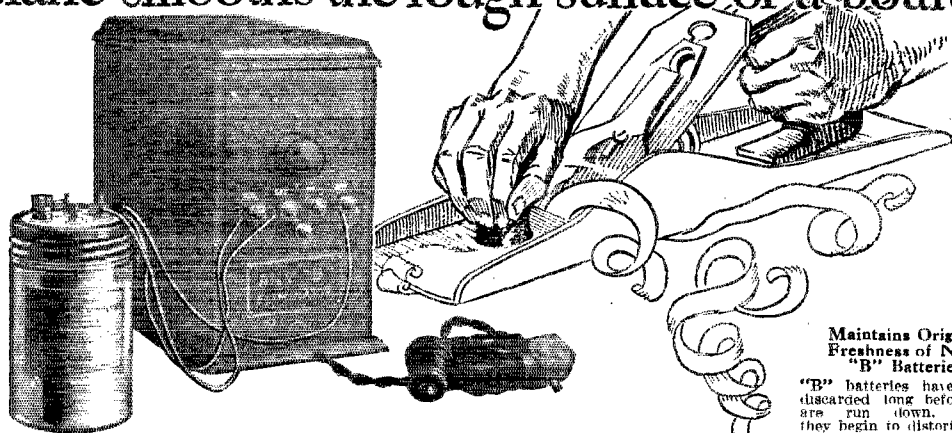

Maintains Original Freshness of New "B" Batteries

"B" batteries have to be discarded long before they are run down, because they begin to distort broadcasts and get noisy. This is because the internal resistance of the batteries increases as they age. Connecting a Mershon across your "B" batteries (with a disconnecting switch) overcomes this high internal resistance and so greatly prolongs the useful life of dry cell batteries. The Mershon itself does not wear out or run down. It may be used continuously with endless sets of "B" batteries.

Makes old "B" eliminators ever fresh like brand new "B" batteries!

Connecting a Mershon condenser to your "B" eliminator vastly improves the tone quality from your receiving set. The famous Mershon's action is two-fold. First, it assists in more perfect filtering (straining) of the uneven current supplied by the Lamp Socket. Second, it acts as a reservoir to store a large amount of energy which is fed to the Receiver in a continuous smooth flow as called for by incoming broadcasts. This action may be considered the same as the result of using a plane for a rough board. Most "B" eliminators use a good filter which can be noted by the lack of any AC hum. But for perfect results and tone quality comparable to that which is obtained from the use of new "B" batteries, it is essential that a sufficient amount of energy be stored directly back of the receiving set. This energy must be on tap to instantaneously supply current for loud or long sustained musical notes. The famous Mershon enables this storage of energy to be accomplished electrically rather than chemically. The result is a great improvement in tone quality. It is particularly noticeable on low notes which require a large amount of current for proper reproduction.

To connect a Mershon is as simple as connecting a battery to your Receiver. Three lead wires are provided attached to the Mershon, the positives being colored red and the negative black.

Caution: Of course it must be realized that a Mershon added to a "B" eliminator will not improve tone quality; or the use of any other tone improvement device; if the design of a receiving set or loud speaker is such that the tubes or loud speaker are overloaded.

There are many other uses for Mershon condensers. Write Dept. 4B7 for descriptive folder.

AMRAD CORPORATION
Medford Hillside, Mass.
Harold J. Power, Pres.

\$ 8.

AMRAD

Transmission Assurance

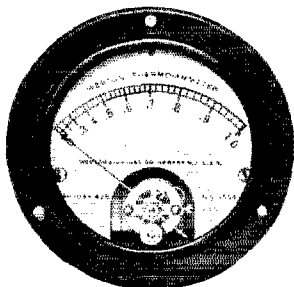

Weston Model 425. Now more attractively priced. (Milliammeters, all ranges—\$15. Ammeters from 1 Ampere to 5 Amperes—\$13.50, 6 Amperes to 20 Amperes—\$14.50.)

NO greater assurance of transmission success can be given than by the use of a Weston Model 425 Thermo-Couple Type Ammeter. Its precision for the measurement of antennae current, high frequency, alternating current of low frequency, and direct current has made it popular with enthusiasts everywhere. It makes a noteworthy contribution to Radio transmission by eliminating the numerous difficulties of the use of the "hot-wire expansion type". For accurate, dependable radio results Weston Quality Radio Instruments are essential. Write us for complete information.

WESTON ELECTRICAL INSTRUMENT CORPORATION
158 WESTON AVENUE, NEWARK, N. J.

STANDARD THE WORLD OVER

WESTON

Pioneers since 1888

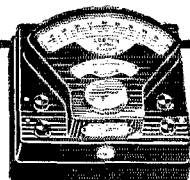

RADIO OPERATORS WANTED

THE EASTERN RADIO INSTITUTE can train you quickly and thoroughly because:

MODERN AND EFFICIENT METHODS
THOROUGH INSTRUCTION under staff of
LICENSED COMMERCIAL OPERATORS
MODERN APPARATUS including SHORT WAVE
TRANSMITTER

FOURTEEN years a RADIO SCHOOL
THE OLDEST, LARGEST and MOST SUCCESSFUL
school in New England. RECOMMENDED BY THE
A. R. R. L.

Day or Evening Classes Start Every Monday.

SPECIAL CODE CLASSES

Write for Illustrated Prospectus

EASTERN RADIO INSTITUTE

899 BOYLSTON STREET BOSTON, MASS.

Bound Volume X of QST

We have now a limited number of copies of Bound Volume X of QST. Vol. X comprises the entire 1926 series of QST. This volume is made up of two books or sections, each containing six issues of QST. This volume is handsomely bound in red cloth and with gold imprint. The complete volume is priced at \$5.00, postpaid.

Better act quickly—only a few copies available.

QST, 1711 Park St., Hartford, Ct.

Never Before At This Sacrifice Price

HIGH VOLTAGE

KENOTRON RECTIFYING TUBES

MODEL U. V. 217

A. C. Plate Voltage 1500 volts. Filament Voltage 10 volts.

Used with U. P. 1016 Power Transformer or similar Transformer.

These Genuine R.C.A. U. V. 217 Tubes are very efficient Rectifiers and they will pass plenty of current and voltage for 50 watters and H Tubes and also can be used for 250 watters. Every tube is brand new and packed in original carton.

List Price \$26.50 ea.

EXTRA SPECIAL, \$12.50 EA.

AMERICAN SALES COMPANY

21 WARREN STREET, NEW YORK CITY



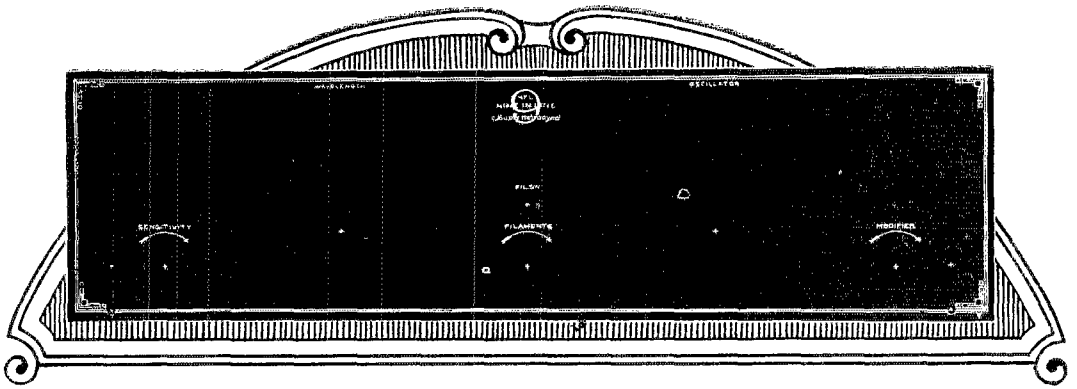

Formica Kit Panels

FROM one end of the country to the other, home set builders are producing handsome radio sets by the use of Veri Chromed Formica panels for the leading kits.

These panels include the Karas Equamatic, Bremer Tully Power Six, H. F. L. Nine-In-Line Superheterodyne with sub panel, Victoreen single dial and two dial. There is also an Infradyne 7 x 28" and 7 x 30" Aerodyne, St. James 8 Tube, Bremer Tully Counterphase, Brown-ing Drake National, Madison Moore Superheterodyne, Camfield Duoformer and two sizes of Best's Superheterodyne. They are sold by the leading jobbers and dealers.

Special Panels cut to size and Formica Tubing
are also available for Amateurs

THE FORMICA INSULATION COMPANY

4616 Spring Grove Avenue

Cincinnati, Ohio

Hear the
FORMICA
Orchestra Tues-
day 9 to 10
over WLW

FORMICA
Made from Anhydrous Bakelite Resins
SHEETS TUBES RODS

Formica has a
Complete Service
on Insulating
Material
for Radio
Manufacturers

The **ULTIMATE** SEMI AUTOMATIC **TRANSMITTER** will improve your sending

For accuracy, carrying capacity, ease of operation and appearances this is the transmitter you will ultimately use. It is fast replacing the old key and other semi-automatic transmitters in all stations.

\$17
Delivered

Officially approved by Western Union Telegraph Co. for use on their wires.

The only transmitter with mechanism under lock and key, giving protection against tampering with adjustments, dirt, or weather.

Send for free descriptive literature or order from

The Ultimate Transmitter Co.

Jewelers Exchange Bldg., Los Angeles, Cal.

Canadian Agent

W. H. MENERAY, 381 Balmoral St., Winnipeg, Man.

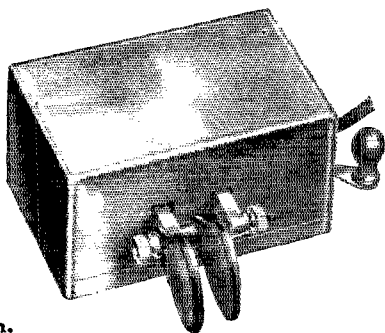

Hoyt Radio Rotary Meter

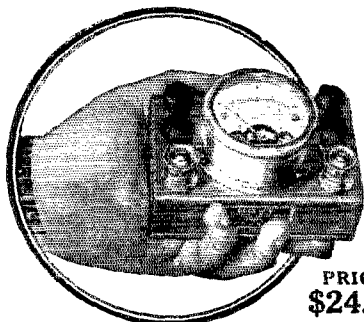

PRICE
\$24.00

This is a unique 5-range precision moving coil voltmeter, made especially for the Radio Service Man, Dealer and Owner. It will make all tests necessary on Radio Receiving Sets, tubes, batteries and battery eliminators. It is rugged and will last a lifetime, yet will retain its extreme accuracy. Operation is simple and accident-proof.

BURTON-ROGERS CO.

857 Boylston Street Boston, Mass.

Sales Dept. for Hoyt Electrical Instrument Co.

HOYT makes a complete line of Radio Meters. Send for booklet, "HOYT Meters for Radio."

Modernize Your Set for **\$2.50**

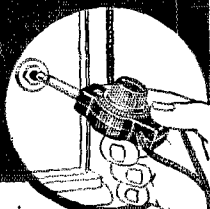

TONE improvement is this year's only real radio advance. Just one change will modernize your present set. Replace your loud speaker plug with the Centralab Modu-Plug and your set will equal the tone performance of the latest high-priced receivers. Gives any degree of tone volume. No other control but the small knob on the plug. Interfering noises are reduced.

\$2.50 at your dealer's or mailed direct on receipt of price.

Central Radio Laboratories

20 Keefe Ave., Milwaukee, Wis.

Centralab Variable Resistances are used by 69 makers of leading standard sets.

Centralab

Power from the Light Circuit

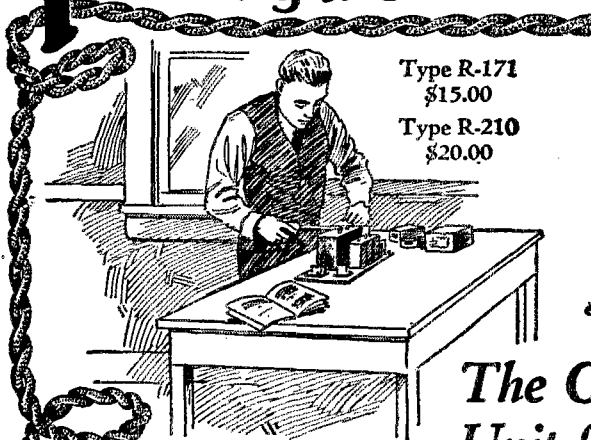

Type R-171
\$15.00
Type R-210
\$20.00

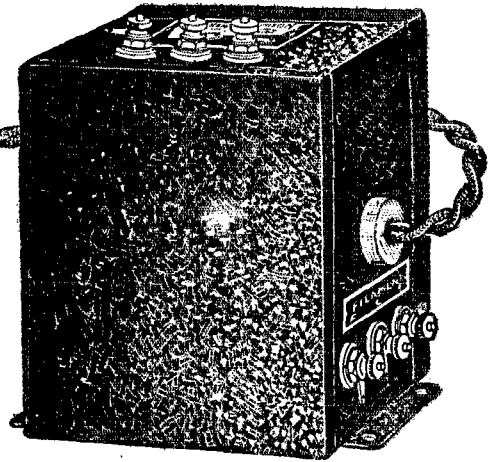

The Complete Foundation Unit for Home Constructed Power Amplifiers

HERE is what you have been waiting for—a silent and efficient power amplifier and B eliminator that will equal anything on the market—one that you can build yourself in less than an hour.

The Thordarson Power Compact is the complete foundation unit for power amplification. It contains: (1) a power supply transformer, (2) two filter choke coils of 30 henries, and (3) a power tube filament supply, tapped at the exact electrical center (an exclusive Thordarson feature), all in one compound filled case.

Two types of Power Compact are available: R-171 is designed for use with power tube UX-171 and Raytheon BH rectifier. Type R-210 is designed for use with power tube UX-210 and UX 216-B rectifier. Each type of compact supplies the proper values of current for maximum efficiency operation of its corresponding power tube.

Packed with each compact is a complete set of instructions which can easily be followed, even by the man with no radio experience.

Remember that when you buy a Thordarson product it is guaranteed and backed by over thirty years' manufacturing of reliable transformers.

For Sale at Good Dealers Everywhere
or Direct from Factory

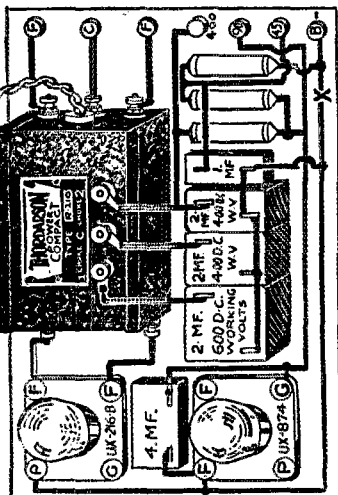

B-ELIMINATOR AND SUPPLY FOR UX-210 POWER AMPLIFIER—

This Booklet is Yours for the Asking

POWER FROM THE LIGHT CIRCUIT*

THORDARSON ELECTRIC MFG. CO.
500 W. Huron St., Chicago, Ill.

Gentlemen:

I would greatly appreciate receiving a copy of your new booklet "Power from the Light Circuit."

Name.....

Address.....

City..... State.....

THORDARSON POWER COMPACT

THORDARSON ELECTRIC MANUFACTURING CO.
WORLD'S OLDEST AND LARGEST EXCLUSIVE TRANSFORMER MAKERS
Chicago, U.S.A.



A-B RELAY

The Jewell A-B Relay is an automatic switch for connecting and disconnecting the B-eliminator and trickle charger of a radio set. When the filament switch is turned on the A-B Relay connects the B-eliminator and disconnects the trickle charger. A reverse action occurs when the filament switch is turned off.

It is very convenient and practical.

A very efficient, low resistance, magnet actuating special silver-carbon contacts and connected in series with the A-Battery and the tube filaments comprise the essential part of the A-B Relay.

Write for descriptive form No. 1023

Jewell Electrical Instrument Co.

1650 WALNUT ST. - - CHICAGO

27 YEARS MAKING GOOD INSTRUMENTS



A-B RELAY

- Smooth-
- Positive-
- Reliable-



CARTER

"Midget" Rheostat
With
Filament Switch

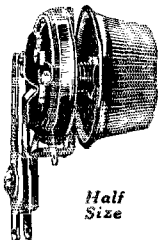

\$1

All Resistances

- 2 ohm*
- 3 ohm*
- 6 ohm*
- 10 ohm*
- 15 ohm*
- 20 ohm*

Half Size

- 25 ohm
- 30 ohm*
- 40 ohm
- 50 ohm*
- 75 ohm*

*R. M. A. Standard

Carter parts are used in Hammarlund-Roberts HI-Q, B-T Counterphase Power 6 Kit; LC-27 (Popular Radio), Improved Krowning Drake with Lynch Amplifier; Victoreen; Carborundum; Batteryless Receiver; Infradyne; Kuras Equamatic; New Daven Bass Note Receiver, Silver Marshall Shielded Six, and a host of other kits.

Any Dealer Can Supply

In Canada—Carter Radio Co., Limited, Toronto

CARTER RADIO CO.
CHICAGO

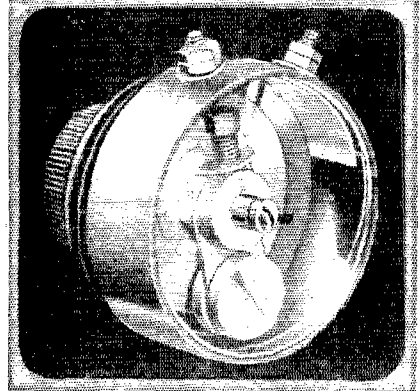

Note the difference!

INSTALL FROST-RADIO Super Variable Resistance Units in your new set and note the difference! Nearly all of the new radio circuits call for one or more of these new non-inductive high resistance units. They are smooth and noiseless in operation and give any degree of resistance from zero to maximum without steps or jumps. Type 880 (2 terminals) is supplied in resistances of 50,000, 100,000, 200,000 and 500,000 ohms; type 890 (3 terminals) in 400, 2,000, 50,000, 100,000, 200,000 and 500,000 ohms. Both types, list \$1.25 each. Your dealer has them.

HERBERT H. FROST, Inc.

160 N. LaSalle Street

New York

CHICAGO

Los Angeles



ALMOST MAGIC

If it were not a scientific discovery of first magnitude it could easily be called Magic —

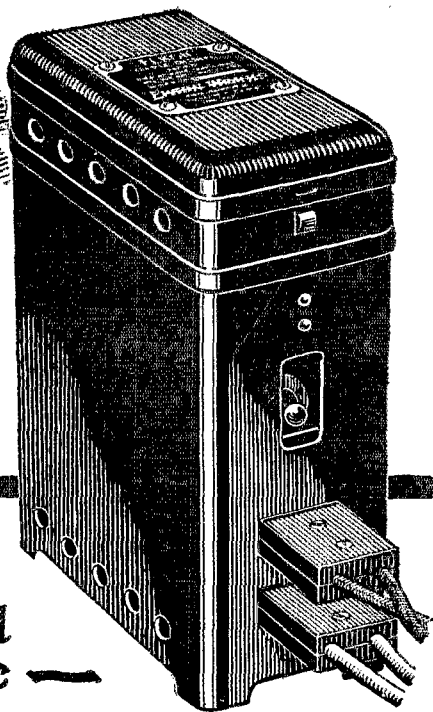

IF the electric lights in your home turned themselves on when it got dark, and off when you went to bed—then you would have something as AUTOMATIC and as EASY TO OPERATE as the efficient

Elkon Trickle Charger

You do NOTHING to an ELKON except attach it to an electric light socket, to your "A" battery, and turn it "on".

It will then replenish your "A" battery. But it won't overcharge because it *automatically tapers off as the battery becomes charged.*

The battery will not run down . . . because *the charger automatically starts charging when the battery begins to run down.*

There is nothing to fuss with or worry about; no extra switch or equipment is needed. There are no moving parts to cause interference; no tubes to break or burn out, no liquids to spill, dangerous acids or alkalis to cause trouble, and NO NOISE WHATSOEVER.

Short circuiting cannot harm it. It does not heat up. There is nothing to watch, replenish or adjust.

This remarkable invention, which has revolutionized every former conception of battery charging,

has been developed and tested for several years. It is exclusively ELKON and is offered to you with a proven record of accomplishment under service conditions in every part of the country. It assures you a freedom from battery charging troubles you have never believed possible . . . an unparalleled service at a very low cost. It is for sale at radio stores everywhere.

Operates from alternating current (direct from light socket) 105-120 volts, 50-60 cycles. A model for 105-120 volts 25-40 cycles also furnished at a slightly higher cost.

ELKON WORKS
Subsidiary of P. R. Mallory & Co., Inc.
Weehawken, N. J. Inc.

Sole licensees under patents pending to Samuel Ruben

ALSO MANUFACTURERS OF

**Elkon 3 Ampere
Charger**

Elkon "A" Power

For Automobile and Radio "A" batteries. Combines the Elkon Rectifier with a new and superior type charger.

A remarkable achievement, for which radio has been waiting. A positive functioning "A" Power, based upon the proved, exclusive Elkon rectification principle.

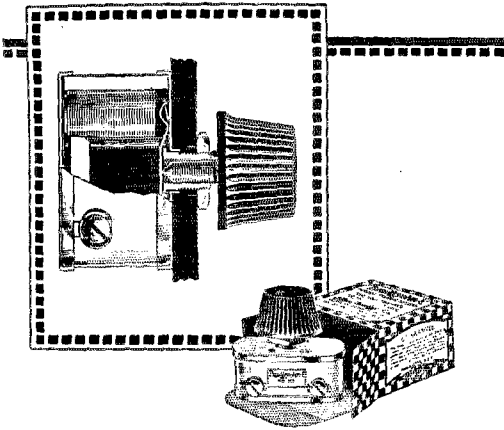

Use Allen-Bradley Resistors for B-Eliminator Hook-Ups

THE success of a B-Eliminator hookup depends as much on the operation of the variable and fixed resistors as it does on the type of circuit used. Allen-Bradley variable and fixed resistors lead the field for this service. Use them in your B-Eliminator hookup.

Bradleyohm-E

PERFECT VARIABLE RESISTOR

This new oversize resistor is used as standard equipment by leading B-Eliminator manufacturers such as Acme, All-American, Majestic, Philadelphia Storage Battery, and Willard. It is the ideal variable resistor for controlling plate voltage output. The scientifically treated discs in Bradleyohm-E provide stepless, noiseless, plate voltage control, and the setting will be maintained indefinitely. Do not experiment with makeshift variable resistors, when Bradleyohm-E has been pronounced the ideal unit by the largest manufacturers of B-Eliminators in the world.

Bradleyunit-A

PERFECT FIXED RESISTOR

Another triumph of the Allen-Bradley Research Laboratory is Bradleyunit-A, a perfect fixed resistor that contains no glass, requires no hermetic sealing, and can be soldered into place without the use of clip mountings. Bradleyunit-A is not affected by temperature or moisture and it maintains its calibration indefinitely.



MAIL THE COUPON

ALLEN-BRADLEY COMPANY
211 Greenfield Avenue
Milwaukee, Wisconsin

Please send me your literature on Allen-Bradley radio devices and B-Eliminator hookups.

Name _____

Address _____

Operate your radio set from the light socket with Balkite "B" and a Balkite Charger

Ask your radio dealer

FANSTEEL PRODUCTS CO., INC.
North Chicago, Ill.

ADVANCE

"Sync" RECTIFIER

the favorite with amateurs

Although lower in price, the ADVANCE Sync Rectifier is far superior in quality—as proven by its prevailing use in international transmitting. It actually does what other rectifiers claim to do. Meets all requirements for heaviest duty. Can be easily and quickly filtered. Speedy starting because of Advance Bakelite wheel. Requires no attention—always ready.

Revolving disk is moulded bakelite six inches in diameter. Nickel plated brush holders with adjustable gauze copper brushes.

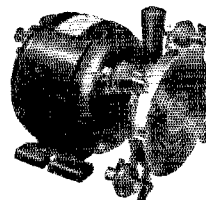

Convenient control handle. Disk, aluminum brush arm support and brush holders perfectly insulated.

Price complete with Westinghouse $\frac{1}{2}$ H. P. Synchronous Motor ... \$40
Rectifying wheel with complete brush assembly and mounting ring to fit your own motor ... \$15

We Pay All Transportation Charges in U. S. A.
ADVANCE ELECTRIC COMPANY
1260-1262 West Second St., Los Angeles, Calif.

Insist on hearing  *this receiver*

42 Stations in 30 Minutes

**Miami Beach at 5.30 in the afternoon from within
one half mile of Station WBBR, New York City—**

Chicago on the same afternoon without an antenna—

These are just a few recent feats performed by an assembled R. G. S. Receiver. The R. G. S. Receiver, built by David Grimes for modern broadcast conditions and employing a new application of the Inverse Duplex System, is a development that will leave an indelible impression upon all receiver design.

The R. G. S. is offered complete in kit form in order to keep the price down to "rock bottom," thus allowing more people to take immediate advantage of this new principle of construction that establishes new standards for selectivity, distance, sensitivity and tone quality. Price \$69.70, without accessories or cabinet.

Authorities in the radio field, such as Arthur H. Lynch, Robert S. Kruse, R. W. Cotton, Volney Hurd, Willis Kingsley Wing and Zeh Bouck, have greeted the R. G. S. Receiver with unprecedented enthusiasm. They are as amazed by its performance as you will be.

Write today giving us your name and address and the name and address of your dealer. We will then arrange for a demonstration of an assembled R. G. S. Receiver in your territory and you can determine for yourself just what is behind our claims. No obligation.

Write

**R. G. S. Sales Division
Grimes Radio Engineering Co., Inc.**

285 Madison Ave., New York City

DEALERS: *Write for complete merchandising information*

BUILT FOR MODERN  **BROADCAST CONDITIONS**

Two Times Two!

"Built Better"—this always has been, and is the policy of AEROVOX.

One year ago the demand for high grade Fixed Mica Condensers, Filter Condensers, Power Supply Condenser Blocks, and Lavite Resistances forced us to double our floor space and equipment.

Today, even though we are now operating on a 24 hour schedule, we are *again* compelled to double our facilities. With our present plant in full swing—without costing our customers one single production day—we are moving to new quarters at 60-72 Washington St., Brooklyn, N.Y.

"Two times two"—this is our growth for the year just passing. Does the "Built Better" policy pay? AEROVOX thinks so. More than 200 radio manufacturers and thousands of you fans evidently think so, too.

Wherefore, we thank you!

AEROVOX

WIRELESS CORP.
60-72 Washington St., Brooklyn, N.Y.





No. 3527
Unit

No. 3516

Increase the Volume of Your Present Set
It is easy now to get much greater undistorted power from your present radio receiver whether it has 2 tubes or 8 tubes. At the same time and at little additional expense you eliminate the need of B-Batteries.

No. 3527 Unit
Full Wave Rectifier for use with one UX 213 tube and power amplifier UX No. 171 tube. This unit includes one No. 2505 transformer and two No. 514 chokes. Full Power and B-Battery Eliminator.
No. 3527—\$15.00 List

No. 3516
Full Wave Rectifier for use with one Raytheon BH tube and one UX No. 171 tube. This unit includes one No. 2593 transformer and two No. 514 chokes built into substantial metal case. Exceptional power for all purposes. Eliminator B-Batteries.
No. 3516—\$13.00 List

FANS—Send check or money order to factory if your dealer cannot supply you. Deliveries are prompt.

MANUFACTURERS—As exclusive parts manufacturers Dongan offers the receiver and battery eliminator manufacturer a reliable source of supply. Our engineering dept will co-operate with you in effecting the proper designs of the latest types for your requirements. Ask for a representative or send your specifications.

Dongan Electric Manufacturing Co.
2999-3001 Franklin St., Detroit, Mich.

TRANSFORMERS OF MERIT FOR FIFTEEN YEARS

CROSLLEY



Single Drum
CONTROL

\$50

27 Stations
brought in
distinctly on
loud speaker
in 30 minutes

"The other night I tuned in 27 stations, loud and clear, just like the Cincinnati stations, three of which were going full blast. I identified each program, didn't hear any others in the background,—all with one finger.

The air was certainly full. It was between 7:00 and 7:30 P.M., Central Standard Time. Some stations were less than a dial marking apart. It is amazing how the jiggers they call "Acuminators" helped on such fine separation. I'd like to see some two hundred dollar sets do as well!"

Name on request.

Write Dept. 18, for Catalog

THE CROSLLEY RADIO CORPORATION
Cincinnati, O. - Powel Crosley, Jr., Pres.
Prices slightly higher west of the Rockies



Reliable

LONG DISTANCE COMMUNICATION

on

1 meter to 200 meters

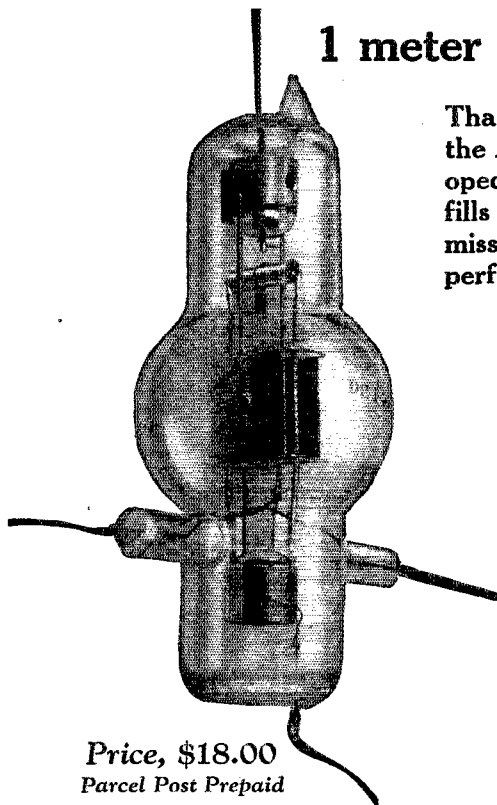

Price, \$18.00
Parcel Post Prepaid

Thanks to the co-operation of members of the A-R-R-L, De Forest has further developed the Type-H tube to a point where it fills *all* the requirements of amateur transmission. The result is still more uniform performance with extended filament life.

Technical Data

INPUT RATING 150 WATTS

Plate Voltage 500—3000
Plate Current 40-50 MA.
Fil. Voltage 10
Fil. Current 2.35A



HR Thermionic Rectifiers

Will operate 4 H Tube.

Fil. Voltage	10
Fil. Amperes	2.35
Plate Voltage A. C.	2000
Plate Mill Amps.	250 Max
Voltage Drop	400 at 250 MA
PRICE	\$16.00

Sold and Shipped Direct
Upon Receipt of Money Order

DE FOREST

TYPE-H

TRANSMITTING TUBE

139 Franklin St.

DE FOREST RADIO CO.

Jersey City, N. J.

SAY YOU SAW IT IN Q S T—IT IDENTIFIES YOU AND HELPS Q S T

YOU NEED THESE PLUG-IN COILS

Note the many advantages of these better and different coils listed below and try to do without them

1. Positive contact is secured through snug fitting plugs and jacks of special design.

2. With 3 Coils, continuous, gapless range is secured from 140 to 16 meters. One of the 20-40-80 meters amateur bands is located in the middle of the tuning range of each of the 3 coils. (For this a SFL Condenser, 140 mmfd. max. cap. is essential.)

3. Operation of regeneration condenser has no effect on the tuning; the 2 controls are completely independent.

4. Antenna coupling is adjustable; by a primary coil

and not through a condenser. Secondary coils are specially constructed so that setting of primary coil does not need to be changed when secondaries are exchanged.

5. Coils are space-wound solenoids on skeleton frames.

6. Both tickler and antenna coil are at filament end of the secondary.

7. These coils cover the 3 U. S. Amateur Bands, all European Amateur Bands, Short - Wave Broadcast, U. S. Naval and Commercial Short-Wave Stations, etc.

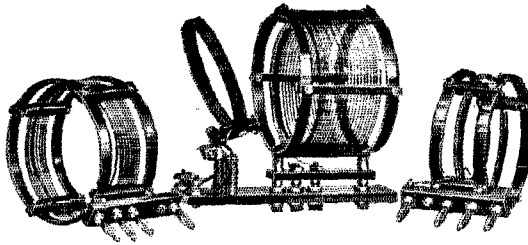

The Kit Illustrated Covering 15 to 133 Meters Complete \$12.50

Coil No. 4, 125-250 M

Price \$4.00

Coil No. 5, 235-550 M

Price \$4.00

Get these coils from your nearest dealer, or order direct from the factory

AERO PRODUCTS INCORPORATED, Dept. 16, 1768-1772 Wilson Ave., Chicago, Ill.

SM

635 Short Wave Kit

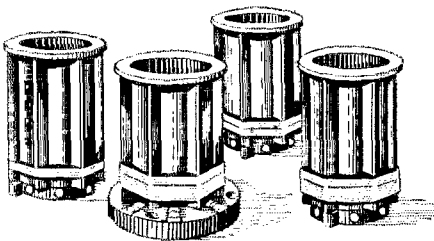

Specified by the most prominent engineers in the country today. Carried by Commander Dyott in his expedition of exploration to the River of Doubt, his receiver being supplied and recommended by RADIO BROADCAST—need more be said about the "sure fire" dependability of the S-M short wave assembly?

The 635 Short Wave Kit consists of four coils, a coil socket, two short wave condensers and an antenna condenser. The price is \$23.00. Type 117 Short Wave Coil set consists of 4 plug-in coils covering 18 to 150 meters, using any standard .00014 condensers, and can be bought for \$11.00, if you will simply ask your dealer for the S-M Short Wave Kit.

Silver-Marshall, Inc.

358 West Jackson Blvd.

Chicago, U. S. A.

Bradley Leak

THE PERFECT GRID LEAK



Provides a noiseless range of grid leak resistance from 1/2 to 10 megohms. Assures most effective grid leak resistance value for all tubes. Small grid condenser (0.00025) is separate. Metal parts nickel plated. One hole mounting.

Allen-Bradley Co.

Electric Controlling Apparatus

277 Greenfield Ave., Milwaukee, Wis

A Laboratory Product



CRESCENT LAVITE RESISTANCES

for Distortionless Amplification

Final resistances for DeForest "H" tube or one or two 6H5 watters, \$3.50. Special Grid leaks for any tube to order. Let us solve your voltage drop problems. Use all tubes in a crystal controlled transmitter on main generator. Our resistances will take care of the different voltage requirements.

CRESCENT RADIO SUPPLY CO. 1 Liberty St., Jamaica, N. Y.

NEW LEARNERS BUZZER PRACTICE SET

on base board, consists of key and buzzer, \$1.00; U. S. Signal Corps. Field Telephone sets, \$3.00; Marconi hand driven U. W. Magnet generators, 2500 rpm, 1500 volts, D. C. 12 mil. \$12.50; Send and receive, nine Terminal Cam Switches in case (British) type SPS 42, \$1.75; Edison Storage Batteries, 10 volts, 8 twin cells in case, type L-4, \$5.00; Just a sample of our bargains. Get our new and latest reduced price list for 2c stamp. We bought \$10,000 worth of United States Government Radio Transmitting and Receiving Sets and Parts. Mail orders sent all over the world.

WEIL'S CURIOSITY SHOP

20 South 2nd St.,

Philadelphia, Pa.

the Illuminated Dial

NATIONAL Velvet Vernier Type C

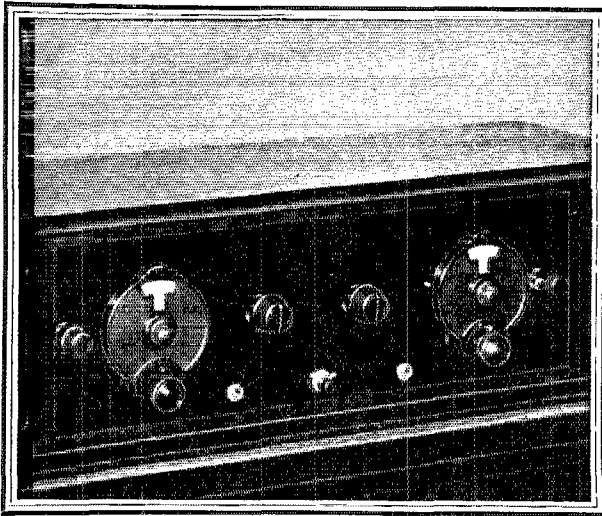

By Day,—

the National Velvet-Vernier *Illuminated* Dial Type C is indistinguishable from its sister—Type B, with beautiful, durable, heavy Bakelite Case—*variable* ratio of 6 to 1 to 20 to 1, clear figures, unexcelled smooth velvety action.

By Night,—

the clear, glareless light of the National Illuminated Velvet-Vernier Dials *invites* you to your Radio in a quiet corner,—for a tour of the Continent or a stay at home with your favorite local. With all the famous Velvet-Vernier qualities and very easy to attach. . . National Velvet-Vernier Dial Type C. Price \$3.00 each.

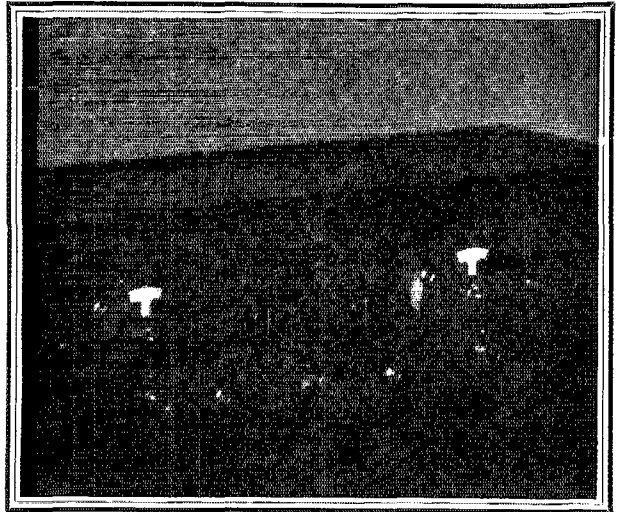

National Company, Inc., Engineers and Manufacturers,—W. A. Ready, Pres., Cambridge, Mass. Makers of NATIONAL BROWNING-DRAKE Coils and R. F. Transformers, Impedaformers, Condensers, Power Transformers, etc., for Radio. Send for Bulletin 116-QST-2.

BE SURE YOU BUY THE GENUINE

NATIONAL
RADIO PRODUCTS

Automatic silent "A" Battery Charging— always on the job!

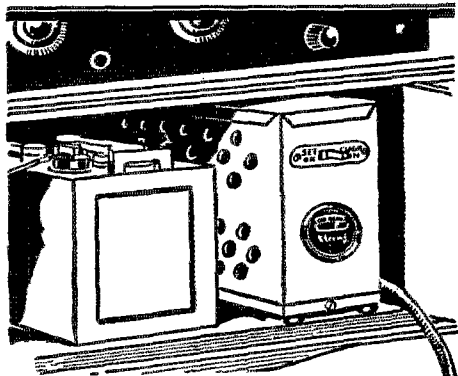

THE Storage Battery that is charged now and then, gradually loses power and reception begins to suffer. If, however, you put this noiseless trickle charger to work, your "A" Battery will be maintained at full efficiency all the time without your giving it a thought.

Equipped with combination switch controlling the "A" charging and radio reception, and indicator to prove that the battery is actually charging.

Charges 6 volt "A" Battery at $\frac{2}{3}$ amp. and 4 volt Battery at $\frac{1}{2}$ amp.

Made in 2 Models:

- | | |
|--|---------|
| R-101, with combination switch | \$14.00 |
| R-102, with Automatic Control | \$17.50 |

Sterling TRICKLE CHARGER

Send for the Sterling booklet *S* showing complete line of radio equipment and useful data on radio care.
THE STERLING MFG. CO.
2831 Prospect Ave., Cleveland, O.



Lowest Wholesale/ Prices

LR-4 KITS NOW READY FOR DELIVERY

Madison Multi-Chokes, Cockaday J.C.-57, Hammarlund-Roberts, Alden Triphonic, AmerTrau Power Pack, UHimax, Infradyne, Benjamin Coutrolladyne Kits in stock.

JOBBER-DEALERS PROFESSIONAL SET BUILDERS

Before buying, get our quotations on our GUARANTEED KITS. 3-Hour Shipping Service.

1927 BUYING GUIDE

A few copies left for Dealers and Professional Set Builders. Send for yours today. 11's free! Address Dept. Q

We are the exclusive direct representatives of the Committee of 21 Manufacturers.

Allen-Rogers

Incorporated
Kit Headquarters
118 East 28th St., New York, N.Y.

Third Edition—Revised

Just Off the Press

"RADIO THEORY AND OPERATING"

By MARY TEXANNA LOOMIS

885 Pages—700 Illustrations—Price \$3.50. Used by the Department of Commerce, All U. S. Naval Training (Radio) Schools, U. S. Coast Guard Academics, U. S. Signal Corps, also all Radio Institutions in U. S. and Canada and many Universities, Technical Colleges, and High Schools. Buy of your dealer, or send us check, express, or money order.

LOOMIS PUBLISHING COMPANY

Dept. T-405 Ninth St., Washington, D. C.

Selected by engineers for use in leading circuits because they're

metallized!



DURHAM
RESISTORS

BUILD THE NEW, SHIELDED

Hammarlund
ROBERTS
Hi-O

Send 25c for Construction Book
HAMMARLUND-ROBERTS, Inc., 1182-H Broadway, NEW YORK

BROWNING-DRAKE RADIO

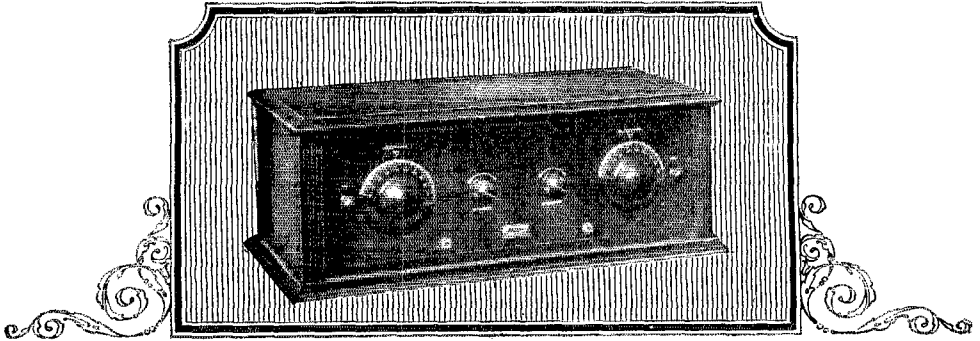

TESTED . . . *Then* *Highly* ENDORSED

SINCE its introduction several years ago, Browning-Drake Radio has been TESTED by thousands of radio amateurs throughout the world . . . then whole-heartedly ENDORSED for dependable radio reception. This unusual endorsement has put Browning-Drake into a hundred thousand homes where Browning-Drake performance is giving permanent satisfaction to its owners.

By using the one stage of scientifically designed radio frequency incorporating the famous Browning-Drake slot wound transformer, together with the flexibility of dual-control tuning, a combination is to be had that has never been surpassed for all around radio reception.

Browning-Drake produces only one model . . . the Browning-Drake Five which is completely assembled at its Brighton laboratories. Every set is unconditionally guaranteed. You will find the price of only \$95. as amazing as its performance. Ask the nearest Browning-Drake dealer to demonstrate it for you TODAY.

Inquiries from radio amateurs are always gladly received and promptly answered.

[*DEALERS: Don't overlook the Browning-Drake opportunity. Every Browning-Drake dealer has made money and every customer has been permanently pleased. Write or wire TODAY for proposition.*]

BROWNING-DRAKE CORPORATION, BRIGHTON, MASSACHUSETTS

THE SUPER SYNC RECTIFIER

The Synchronous Rectifier That Can Be Filtered

When installing a Super Sync you can rest assured that you will have a steady and unflinching plate supply. The voltage delivered by it is constant thus assuring a steady wave.

The Super will rectify any voltage up to 4000 volts making it adaptable to both high and low powered transmitters. When purchasing a Super for a low powered trans-

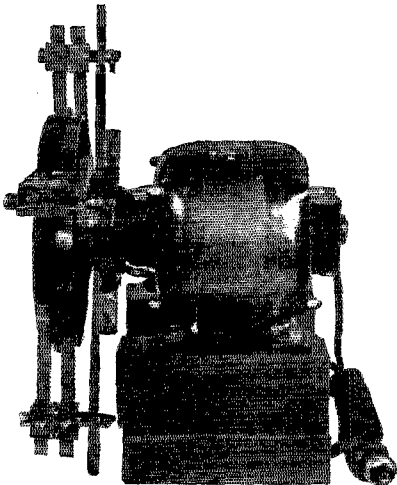

mitter your plate supply troubles are over. Should you intend to build a larger transmitter at some future time the Super will handle the load just as easily as the small load.

The commutator is turned at a synchronous speed by a 1/4 H.P. 1800 R.P.M. synchronous motor. The motor can be supplied for different name plate ratings if desired.

PAT. PENDING

PRICE \$75.00 F. O. B. ST. LOUIS, MO.

MARLO ELECTRIC CO., 5241 Botanical Ave., St. Louis, Mo., U.S.A.

RECEIVERS TRANSMITTERS - EQUIPMENT

Ensell Radio Laboratory Equipment is built to a Quality Standard. All Apparatus is fully Guaranteed. The Highest Quality Parts are employed in our Wavemeters, Receivers, Transmitters, Master Oscillators, etc. Special Equipment built to order. Quotations furnished upon receipt of data on the Equipment you desire. We build any Equipment you desire from your parts or we can furnish same. All Equipment fully Tested and sold with a Dual Guarantee.

Ensell Radio Laboratory

1208 Grandview Ave., Warren, Ohio
"Pioneer Builders of Short Wave Apparatus"

Become a Radio Operator

See The World. Earn a Good Income. Avoid Hard Work. Learn in the Second Port U. S. A.

Radio Inspector located here. Positions plentiful. Splendid Climate. Other advantages to the student unequalled in any other American port. Nearly 100 per cent of operators graduating on Gulf during past four years trained by MR. CLEMMONS, Supervisor of Instruction. Every graduate secures position. Day and Night Classes; enroll anytime. Write for Circular.

Gulf Radio School 844 Howard Avenue, New Orleans, La.

FAMOUS "BH" TRANSFORMERS

BH VIVAPHONIC

For quality of amplification, use the only Low-Loss, Shield Structure Audio transformer made. (Patented) Write for Catalogue Illustrating Audio and Transmitting Transformers.

BENJAMIN HUGHES ELECTRIC CO.
298 LaGauchetiere St., W. Montreal, Canada
Transformer Builders Since 1910

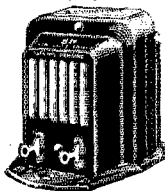

FREE RADIO GUIDE

Short Wave Equipment SPECIAL AMATEUR DEPARTMENT

The Barawik line features this season the Special Amateur Dept. in charge of F. J. Marco, 9ZA. It presents the latest in short wave equipment, transmitting and receiving supplies and everything necessary for the amateur and experimenter. Special attention has been given to short wave kits. It will pay you to get our catalog.

The new 1927 edition of the Barawik Catalog and Guide also gives a comprehensive listing of the radio sets, parts, kits, supplies and accessories necessary in all work. It contains 164 pages of radio's newest developments. Standards equipment of the best-known manufacturers at tremendous savings.

Write today for your free copy of the 164-page guide. Also please include name of other fans you know would be interested.

BARAWIK CO., 540-571 Monroe St., CHICAGO, U.S.A.



SAY YOU SAW IT IN Q S T—IT IDENTIFIES YOU AND HELPS Q S T

When others failed— ACME remained on the job

"BUILDERS AND OPERATORS OF AMERICA'S FIRST RADIO OPERATED AUTOMOBILE"

HOUDINA RADIO CONTROL CO.

RADIO AND ELECTRICAL ENGINEERS

119 DOTY STREET

KAUKAUNA, WISCONSIN

Address reply to:

Nov. 20th 1926

Acme Apparatus Co.,
37 Osborn St.,
Cambridge, Mass.

Gentlemen:-

We take the liberty of advising you that we have used "ACME" apparatus on the "American Wonder", better known as "America's first Radio Operated Automobile", and the controlling transmitter "Station 2XAK" for almost two years.

It is with pleasure that we advise you that your products have given us unusual service, and never failed to function properly in all kinds of weather. Our transmitter is built of "ACME" products exclusively, and where instruments of other make have broken-down or fell to pieces the "ACME" apparatus has remained on the "job".

We write this letter, without request, and with our permission to use same in any advertising matter you may desire.

Respectfully yours,
HOUDINA RADIO CONTROL CO.

EJD/hg



AS usual—Acme again shows its quality and its stamina. And in this there is a vindication of your good judgment—you who were the original users and friends of Acme apparatus. See Acme's

present contributions to quality and elimination at any good dealer's and send 10 cents for new Acme Booklet, "Power Supply for Radio Sets."

ACME APPARATUS COMPANY

Dept. E-21

Cambridge, Mass.

ACME ~for amplification

SAY YOU SAW IT IN Q S T—IT IDENTIFIES YOU AND HELPS Q S T

for
REAL RECEPTION!



KINGSTON

"B" Battery Eliminator

Guaranteed to remove the battery nuisance and deliver clearer tone and increased volume. Provides three different voltages at the same time. Each tap adjustable over a wide range, making possible any desired voltage from 5 to 150, absolutely harmonizing "B" current supply to your set. Raytheon tube used as rectifier. No noise or vibration. Contains no acid or solution and will not get out of order. Operating cost negligible.

At Your Dealer's

Price, complete with Raytheon tube **\$35.00**

KOKOMO ELECTRIC COMPANY
KOKOMO, INDIANA

THE "WINDHAM" Type S.S.O. Condenser

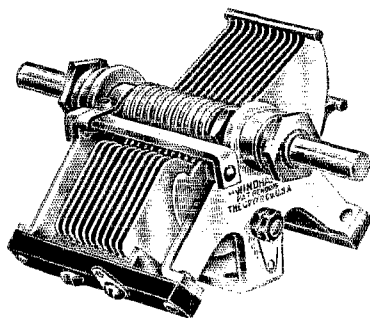

Satisfies Every Condition

Removable $\frac{1}{4}$ " shaft, hollow spindle, uniform station separation, easily mounted on panel or table, the best of materials and workmanship. You have often paid twice as much for a condenser half as good.

Send for Catalog

THE GOYER COMPANY, Willimantic, Conn.

MIDWINTER BARGAINS!

WARREN \$6.00 PHONES

2600-ohm: super-sensitive; ideal for DX. Our special price,

\$1.50

2MFD. CONDENSERS

Capable of standing 500 volts. For B-Eliminators, Filter Circuits or any place where a high quality condenser is needed. Absolutely guaranteed against breakdown within the voltage specified. Packed in lacquered metal cans: **85c**

MORE CROSLY SETS!

Just received another lot of Crosley No. 51, 2-tube sets. We sold so many through QST last month that we're offering them again at our bargain price of

\$3.95

ACME LOW-LOSS TUNER

Low loss; single hole mount; space wound. Primary of litz wire; secondary of spaced enameled wire and tacker of silk wire. Entire form made on bakelite. **SPECIAL PRICE**

\$2.75

RATHBUN CONDENSERS

11, 23, and 43 plate. A \$5.00 condenser specially priced at

\$1.00

RADIO SURPLUS CORPORATION
250 Washington St., Boston, Mass.

HAM-ADS

NOTICE

Effective with the July issue of QST the policy of the "Ham Ad" Department was altered to conform more nearly to what it was originally intended that this department should be. It will be conducted strictly as a service to the members of the American Radio Relay League, and advertisements will be accepted under the following conditions.

- (1) "Ham Ad" advertising will be accepted only from members of the American Radio Relay League.
- (2) The signature of the advertisement must be the name of the individual member or his officially assigned call.
- (3) Only one advertisement from an individual can be accepted for any issue of QST, and the advertisement must not exceed 100 words.
- (4) Advertising shall be of a nature of interest to radio amateurs or experimenters in their pursuit of the art.
- (5) No display of any character will be accepted, nor any typographical arrangement, such as all or part capital letters, be used which would tend to make one advertisement stand out from the others.
- (6) The "Ham Ad" rate is 7c per word. Remittance for full amount must accompany copy.
- (7) Closing date: the 25th of second month preceding publication date.

THE life blood of your set—plate power. Powerful, permanent, infinitely superior to dry cells, lead-acid Bs, B eliminators. Trouble-free, rugged, abuse proof, that's an Edison Steel-Alkaline Storage, B-Battery. Upset electrically welded pure nickel connectors insure absolute quiet. Lithium-Potassium solution (that's no lye). Complete, knock-down kits, parts, chargers. Glass tubes, shock-proof jars, peppy elements, pure nickel, anything you need. No. 12 solid copper enameled permanently perfect aerial wire \$1.00; 100 ft. Silicon steel laminations for that transformer 15c lb. Details, full price list. Frank Murphy, Radio 8ML, 6406 Carl Ave., Cleveland, Ohio.

PURE aluminum and lead rectifier elements, holes drilled, brass screws and nuts, pair 1/16", 1" x 4", 13c, 1 x 6 15c, 1 1/2 x 6 17c, 1 1/2 x 6 19c. Sheet aluminum 1/16" \$1.00, 1/8" \$1.90. Lead \$1.00 square foot all prepaid. Silicon transformer steel cut to order .014". 10 lbs. 25 cents, 5 lbs. 30 cents, less than 5 lbs. 35 cents per lb. 4 cubic inches to the lb. Postage extra. 1/2 cash with order—balance C.O.D. Edgewise wound copper ribbon .350" wide; 3 1/2" outside diameter 10c turn, 4 1/2" 13c turn, 5 1/2" 15c turn, 6 1/2" 17c turn, 7 1/2" 20c turn, prepaid. Geo. Schulz, Calumet, Michigan.

WE want every ham to have a copy of our Hamalog, the most complete catalog and handbook of its kind published. It's free for the asking. Be sure to get it. We handle De Forest transmitting tubes. Type "H", \$18.00, type "D", 10 watts, \$9.00, type "P", 250 watts, \$110.00; also special on 20 watters, \$12.00. Some specials: General Radio wavemeters, type 247W only, 25% off, while they last. UC-1831 condensers, \$1.20. Copper strip 1/4" x 1/16", 4c per foot. New fall Amateur call-books, 75c. ARRL Handbooks, \$1.00. Don't forget to write for the Hamalog, O.M. E. F. Johnson, 9ALD, Waseca, Minnesota.

QSL cards \$1 per 100, highest quality, orders filled immediately, COD or cash with order. William Green, 207 Cathedral Parkway, N. Y. C.

25% to 35% discount to amateurs on receiving parts, no sets. Our weekly data sheets give you more dope than all the radio magazines together. 20 weeks trial \$1.00, 52 weeks \$2.50. Over two pounds data, circuits, catalog, prepaid 25c. Fred Luther Kline, Kent, Ohio.

DODGE radio shortcut produces results quickly. Raw beginners master code easily; hams increase speed rapidly. ICJX Stetson says: "Quickly raised speed to 27 per". 6QUN Connor says: "Mastered code your way in 15 min". 4JUN Briggs says: "Shortcut for speed, now do 27 per". Story of surprisingly rapid progress as told by 200 Users all now licensed also quarter coupons—25 cents. Reports each radio disc and information—on request. Shortcut

SAY YOU SAW IT IN Q S T—IT IDENTIFIES YOU AND HELPS Q S T

with Appendix and Better Key Work \$3.50 US and Canada, elsewhere \$4.00—Reg mail—None COD—Money Order only. C. K. Dodge, Mamaroneck, N. Y.

GENERAL Electric 24/1500 volt .233 ampere dynamometers brand new \$35. With shaft for external belt drive \$38.00. Generate an unusually pure DC. Crocker-Wheeler 24/1500 volt 450 watt \$45.00. Some at \$35.00. GE 12/350 volt .143 ampere \$15.00 Navy SE 1012 range 50-1000 meters brand new \$45.00. Worth \$75.00. Navy Precision Wavemeters fine for lab work \$45.00. Navy Blinker Key CQ 1140 \$2.00. Cost \$16.50. 500 cycle generators all kinds. Fotos, Henry Kienzle, 501 East 84th Street, New York.

LOTS of new R.C.A. UV202 Five watters \$2.50. New R.C.A. \$12.00 loops \$2.25. James Marinell, 8BEP, Youngstown, Ohio.

500 CYCLE 75 volt 375 watt generator 110 volt DC motor on same shaft for sale with or without 60 cycle single phase 3 HP induction motor 110 or 220 volts. Make offer FOB Pelham, New York. Lansingh, 2227 Lakeshore Avenue, Los Angeles, Calif.

WHEN we say low prices we mean just that. Pilot SLW condensers .75 is just one of our bargains. Write for our transmitting and short wave receiving list. Kenneth Hanifan, Waterville, Ohio.

OMNIGRAPHS, vibroplexes, transmitters, receivers, chokes, coils, meters, transformers, condensers, "S" tubes, transmitting tubes, rectifiers, wave meters, eliminators, motor generators, relays, super heterodynes, radiolas,—bought, sold, exchanged. Sell, trade E.I.S. 8 tube super \$50. Guns wanted. I. J. Ryan, 9CNS, Hannibal, Missouri.

WANT side motion key, meters, etc., REL inductance. W. Markert, 5562 Shields, Chicago, Illinois.

13 HONEYCOMB coils to cover all wavelengths; De Forest Mounting; S.P. switch; Baldwin Concert Grand unit and other radio junk very cheap. Merrill Fox, 6UJ, Pox 1775, Salt Lake City, Utah.

SELLING out — 100 watt and 10 watt transmitters. Prices right. Write for list. Want 500 volt motor-generator. 9DIN, New Hampton, Iowa.

SPECIAL—100 Govt. QSL cards \$2. As you want them, two colors \$2.50. Your call on 4x6 card FREE with each order. Fred Church, Millington, Mich.

WANT used R.C.A. or Acme 30, 40 or 50 henry 150 milliamp choke coil. C. R. Bloxton, Frankfort, Kentucky.

700 WATT transformers, 1000-1500 volts on each side of center tap \$14.00. 250 watt transformers 550-700 volts each side \$10.00. Room on both for filament winding. F. Greben, 1927 S. Peoria St., Chicago, Illinois.

FELLOW hams here's your opportunity: For sale: Kennedy type 110 Universal Receiver and type 525 two stage amplifier \$65.00. This set tunes from 150 to 30,000 meters. One 7A Western Electric Amplifier \$50.00. Six S Tubes \$6.00 each. Western Electric 50 Watt Tube \$20.00. One Omnigraph with 15 plates \$18.00. One type 354 General Radio Wave Meter \$15.00. One Emerson Electric 1000 volt Motor Generator set \$75.00. Two U.P. 1015 Power transformers \$10.00 each. Frank L. Root, 3545 Lafayette Ave., St. Louis, Mo. 9BEQ.

WANTED: Omnigraphs, 50-wattors, S-tubes. Price Griffith, 1109 Eighth Avenue, Fort Worth, Texas.

\$2.95—Brand new Gould 24 volt rubber enclosed batteries, about 2500 mills. Hunt Spencer, 3558-65 St., Woodside, New York.

9DCD—Selling out. Write for list. M. W. Clark, Clinton, Mo.

SELL 1 brand new Western Electric fifty watter, \$20.00. 5ASU, P. O. Box 205, Montgomery, Alabama.

FOR sale, all kinds of transmitting apparatus. 5ALH es 5ALA selling out. Apply Joe V. Wright, Miranda City, Texas.

FOR sale—1 UP414 Mod. transformer \$4.50, 3 Kenotron tubes, see page 89 July 1925 QST, \$3.25, 2 pair Brandes headfones each \$2.50, 1-6 volt Briggs battery charger \$5.00, 1-10 watt transmitter with R.C.A. Kenotron, radiotrons, filters, meters, all complete, \$95.00, Edwin R. Carlson, Waterman, Illinois.

REAL DC for 5 w to 500 w CW sets, Westinghouse Cooper-Hewitt Mercury Vapor rectifying tubes, new, guaranteed \$11.75, by express only. Larger sizes. Blueprints, details, photos 25c, refunded on purchase. Wilbur Gemmill, 434 N. Beaver St., York, Penna. 3AAO.

CURTIS-GRIFFITH 250-watt power-filament transformers 350-550 each side \$12.50. Thordarson 650-volt power-filament transformers for 5-watters \$6.90. Thordarson power transformers 350-550 each side \$11.00; 1000-1500 each side \$16.00. Thordarson 550 power-filament transformer \$6.50. Edgewood copper strip 6 inch, turn 12c; 4-inch 10. Aluminum square foot 85c; Lead square foot 85c. Jewell 0-15 Voltmeters \$7.50; 0-500 Milliammeters \$7.50. New "Ham-List" 4c. James Radio Curtis, 5-A-Q-C, 1109 Eighth Avenue, Fort Worth, Texas.

FELLOWS list grows: plans 8 tube superheterodyne, all big tubes, little ones shorter life, little ones if you want them, loop, no potentiometer, very selective, \$1.50. Brown-Drake with successful two RFA going good, \$1.00. 18-1900 meter set \$1.00. All standard parts, nothing to wind. L. W. Hatry, care Hartford Times.

SPECIAL! The new series "B" Sangamo filter condensers, guaranteed for continuous operation at 1000 volts D.C., 2 mfd. \$2.50; 4 mfd. \$4.00. Tube 50,000 ohm grid leaks for deForest "H" tubes, \$1.00. Bradley "Radiostats," the real rheostat for the primary of your filament transformer, \$6.50. Bradley 2000-30,000 ohm variable transmitting grid leaks, \$5.00. R.E.L. all-wave R.F. chokes, \$1.10. Postage prepaid three zones. Full line General Radio and Radio Engineering Laboratories equipment carried. Write for prices. G. F. Hall, 133 East Gorgas Lane, Philadelphia, Pa.

POWER transformers 50H chokes, \$2.00. 30H chokes \$1.75. Eliminator parts, etc., all prepaid. Write for new list, reduced prices. M. Leitch, 32 So. Park Drive, West Orange, N. J.

EVERYTHING for the ham: 1/16" sheet lead and aluminum, \$1.00 per sq. ft., No. 12 "Dyrex" solid copper enameled wire, 1c ft., No. 10 "Dyrex" solid copper enameled wire, 1 1/4c ft. A full stock of Acme and Thordarson transformers and choke coils. Jewell meters and all the rest of the stuff to make that short wave transmitter or receiver. Send for catalogue. "Dyrex for DX." E. J. Nicholson, SBIN, 1407 First North St., Syracuse, N. Y.

LIST for the asking, specials on condensers, dials, sockets and keys. Many other bargains. 9EDU, Republican City, Neb.

NAVY standard compass receivers, SE1440A-150-1250 meters equipped with detector, 3 stages audio, ideal for commercial work and broadcasting stations, \$275. 10/350 volt Navy dynamotors \$25.00. Navy 900 cycle alternators self-excited \$25. Western Electric tubes, UV204 \$95. Dubilier Mica Condensers .004-8500V at \$8. Western Electric 2B Superheterodyne receiver, complete, new \$240. U. S. Navy, Western Electric, Submarine chaser CW936 transmitter, receiver, new, original case, \$225. Long wave navy receivers CN240, \$65. Navy precision wavemeter 100-4000 meters \$100. Navy direct reading wavemeters with galvanometer manufactured by General Radio—range 300-1000 meters. Can be calibrated for shorter waves, Special \$13.50. Guaranteed new. Arthur Faske, 1515 Eastern Parkway, Brooklyn, N. Y.

TRANSMITTING parts for sale. Write E. G. Squires, Wheaton, Illinois.

GENERATORS new 275 volt 120 watts will give 400 volts direct-coupled to 3500 speed motor fine for phone \$8. 3500 speed used motor \$9. Used generators 500 cycle self-excited 1/2 Kw. \$15. 200 watt No. 10 Generators to run on 32 volts Dc. output 300 \$8. 6 volt input, output 400 at 200 watts \$20. Uc1831 variable 4000 volt transmitting condensers \$1.60. 1/2 Kw. motor generators Dc. drive, microphones \$1. 1016 transformers \$11.50. Gearing honey-comb mountings \$1.50. Postage extra on all. Send stamp for list. R. Wood, 46-20, 102 St., Corona, New York.

SELL: Entire equipment at crystal controlled 4WJ. GR type 358 wavemeter, new; Jewell pattern 54 0-1500 DC Voltmeter; motor generator; plate and filament transformers, and complete 100 watt crystal controlled transmitter. Write for list. Radio 4WJ.

WANTED one "S" tube or will sell one. R. E. Davis, Concordia, Kansas.

FIVE Western Electric 50 watters \$28 each. Wanted motor-generator about 2000 volts 1000 watts reasonable. Gordon Brown, 192 South Goodman Street, Rochester, New York, 5BKF.

NOW ready. New ham list. Sent free on request. List those items you have been looking for. See as General Radio wavemeter 14 to 224 meters, \$22.00. Glazed porcelain wall or stand-off insulators 25c. 5000-ohm heavy duty grid leaks \$2.00. Acme transformers and chokes, all sizes and for all purposes. Jewell filament voltmeters \$7.50, radiation ammeters \$12.00, plate milliammeters \$7.50. Pure sheet aluminum 90c and sheet lead 75c square foot. Ammonium phosphate lb. carton 50c and plenty more. Write today for list, from Harris, 5RM, 104 East 10th St., Fort Worth, Texas.

EDISON elements and parts for storage "B" battery units for sale. Type "A" welded elements 5c per pair. Type 3-G. 6c. 3/4x6" tubes, 3c. 1x6" 4c. Separators 4c per doz. Sheet separator 5 1/2x8 1/2" 5c. Potash and Lithium for 5 lbs. solution 85c. No. 20 pure nickel wire, 1c per ft. No. 15, 1 1/2c. No. 16 copper stranded rubber covered hook-up wire 1 1/2c per ft. Complete "B" battery charger, \$2.00. Send for complete list. J. Zied, 904 N. 5th St., Philadelphia, Pa.

QSL hams: Neat original call es heard cards. Sample on request. Tell us what you want. 1NQ, 130 Cornell St., Roslindale, Mass.

COMPLETE 7 1/2 watt transmitters or parts. Write for list. I. W. Erhardt, Enderlin, N. Dakota.

HAM Headquarters—Mueller 150-watt input tubes \$15.00. RCA 5-watters \$3.15. Federal Buzzers \$2.75. Potter 2000-volt 1-mfd condensers \$2.50; 2500-volt 1-mfd \$3.25. Aerovox 1500-volt 1-mfd condensers \$1.75. Good used Vibroplexes \$10.00. R. Curtis, 1109 Eighth Ave., Fort Worth, Texas.

FOR sale—"H" tube in set only 30 days perfect condition. \$12.50. Baldwin "C" headset with two new units, \$5.00. 6ARY.

A.R.R.L. sweater emblems should be worn by all league members. They are made of the highest grade black and yellow felt, 5"x8" diamond, \$1 postpaid. No COD's. Eric Robinson, 135 Jefferson Rd., Webster Groves, Mo.

TRANSFORMERS Thordarson, plate, filament, eliminator and receiving at special prices. Headphones and battery chargers also special. For latest low-price list write 2APJ, 643-5 West 171st Street, New York City.

1000 V. 300 W motor-generator, \$85.00, 1500 V 600 W. double commutator motor-generator \$175.00, 2500 V. 2 kilowatt generator double commutator generator coupled to three phase 220 volt 1750 speed motor, 2500 V. 600 W. double commutator generator coupled to 110-220 V. 60 cycle single phase motor 1750 speed, 1 mfd. Western Electric Condenser 50c. Prices F.O.B. Chicago, James Smat, 1734 Grand Avenue, Chicago, Ill.

AUDIO transformers rebuilt with new best quality windings at half new price. Carefully tested and guaranteed. Loud speakers rewound and repaired, two-fifty to four dollars. A. B. Clark, Albia, Iowa.

FEW new W.E. fifty watters \$27.00. Navy dynamotors 32-350 volts D.C. \$15.00. Karryradio portable case with loop and horn, \$5.00. 2BYJ.

INDUCTANCE rheostats are BWJ Rheostats—a laboratory product. The primary of filament transformer control, permitting balanced center-tap. A reliable unit in daily use, with satisfaction guaranteed, \$3.00 postpaid. 15 cents higher west of Rockies, and Canada. Edwin Hare, 9BWJ, Paintsville, Ky.

Q R A SECTION

50c straight, with copy in following address form only:
CALL—NAME—ADDRESS.

1ACE—Horace K. Hentz, West Harwich, Massachusetts, Cape Cod.

1ARC—Horace K. Hentz, West Harwich, Massachusetts, Cape Cod.

IASR—The St. Paul's School Radio Club, Concord, N. H.

1BMG—Charles H. Stevens, 94 Prospect St., Stafford Springs, Conn.

1BUX—D. H. Borden, Sea-View Ave., Touisset, Mass.

1HH—Charles A. Smith, 73 Water St., Danvers, Mass.

2ABY—Theo. Sirois, Jr., 17 Martens Place, Mount Vernon, N. Y.

2AIR—Francis M. Field, Quarters No. 25, Governor's Island, N. Y.

2AOC—Herbert F. Keonig, 211 Florence Avenue, Irvington, N. J.

2BB—F. Finlay, 355 Central Park, West, New York City.

2CWR—F. H. Mardon, 117-11 140th St., S. Ozone Park, Jamaica, L. I., N. Y.

2EO—William Vollkommer, 48 Windsor Place, Brooklyn, N. Y.

2MK—E. F. Reynolds, Central Valley, Orange County, N. Y.

4CV—Beman Beckwith, 721 So. Boulevard, Tampa, Florida.

5AHT—F. E. Fisher, Drawer O, Breckenridge, Texas.

5AVJ—Dee Walker, Daingerfield, Texas.

6AM—Don C. Wallace, 279 Molino Ave., Long Beach, California.

6BJG—T. D. Garcia, Van Nuys, Calif.

6BP—L. R. Babize, 608 West 107th St., Los Angeles, California.

7QA-71Y—Wm. Donald McKeeth, 412 Seventeenth Ave., Nampa, Idaho.

8AEF—W. A. Hoover, 175 S. Jeff. St., Kittanning, Penn.

8BDM—Lawrence J. Wuske, Box 155, Wiseland Ave., North Industry, Ohio.

8DFY—R. R. Bartlett, 667 Madison Ave., Meadville, Pennsylvania.

8RD—C. H. Vincent, 12694 Northlawn Ave., Detroit, Michigan.

9AYP—Don D. Piehn, 518 Maple Street, Fort Morgan, Colorado.

9CEX—Edward Seppla, Dollar Bay, Michigan, Box 65.

9CJT—Charles V. Meth, 147 Drake Courts, Omaha, Nebraska.

9EDU—C. R. Waggoner, Republican City, Nebraska.

enOWC—W. H. and C. de Beaufort, den Treek, Leusden, (U) Holland.

su1CG—W. Figueira, Magallanes 1070, Montevideo, Uruguay, S. America.

The following stations belong to members of the A.R.R.L. Headquarters gang. Mail for them should be addressed care A.R.R.L., Hartford, Conn.

1MK Headquarters	1ES A. A. Hebert
1AL H. P. Westman	1GO L. A. Jones
1BAO R. S. Kruse	1KP F. Cheyney Beekley
1BDI F. F. Handy	1OA R. S. Kruse
1BHW K. B. Warner	1SZ C. C. Rodimon

SA Y YOU SAW IT IN Q S T—IT IDENTIFIES YOU AND HELPS Q S T

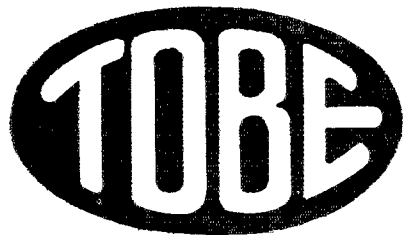

*One object only,
to make and sell
only the best Con-
densers and other
Technical Ap-
paratus.*

Tobe Deutschmann Co.

*Engineers and Manufacturers of
Technical Products
Cambridge, Massachusetts*

PRICES TALK AGAIN

PROMPT RELIABLE SERVICE. All goods sold on money back guarantee. Thordarson combined plate and filament transformer for 7 1/2 watt transmitting set, transformer has 650 volt plate winding and 10 volt filament winding with a center tap, special price \$6.35. Thordarson filament transformer 80 watts, for one to four five watt tubes, \$6.15, 150 watt filament transformer, for one to four 50 watt tubes; Thordarson plate supply transformer, 100 watt \$10.95, 450 watt transformer for up to 200 watt sets \$14.95. Acme power transformers 200 watt \$18.45, 75 watt \$13.75, other Acme transformers reduced. Acme 30 henry 150 mil \$16.20, 30 henry 200 mil \$22.50, Jewell 3 inch flush or panel meters 0 to 8, 10, 15, 20 A. C. or D. C. voltmeters \$6.00, any size of 3 inch milliammeter \$6.00, Antenna current thermo ammeters, any size \$9.85, all sizes of high voltage D. C. meters on hand. Genuine Cardwell condensers double spaced transmitting condenser capacity .00022-3000 volt breakdown voltage \$3.45 Genuine Cardwell .00143 plate condensers \$1.95 R. E. L. Transmitting Inductances double with coupling rods \$8.95 single \$4.65 R. E. L. shortwave coil Kit wave range 10-110 meters reduced to \$3.75. **REAL BUY!** Genuine R. U. A. UC 1803 condensers will withstand 10,000 volts ideal for plate blocking and grid condensers in all modern oscillating circuits such as Hartley tuned grid tuned plate master oscillator crystal control, etc. Price \$.95 Crescent 5000 Ohm transmitting grid leaks \$2.25 Aero short wave coil Kit \$9.50 Sencamo filter condensers 1000 volts working voltage 2 Mfd \$2.25. 4 Mfd \$3.75. We have on hand at all times a complete stock of nationally known parts and kits for Broadcast receivers, and also a complete line of equipment for broadcast transmitters. It will pay you to deal with a brother ham.

NEW ADDRESS

**Radio 2MA 168 Washington Street
New York City**



**This Trademark Symbol is
on All Genuine Patent
Products—the Symbol of
quality of the pioneer radio
parts manufacturer.**

**PACENT ELECTRIC CO., INC.
91 SEVENTH AVE., NEW YORK**

MONEY-SAVERS



MICROPHONE

If you are "on voice" this "mike" is what you need. Spring suspension. Extremely sensitive. Complete with cord.

\$15.00

RCA UV-712 AUDIO TRANSFORMER
9/1 ratio.
List, \$7.00

\$1.60

C. R. L. POWER RHEOSTAT
75c

RCA UL-1008 Oscillation TRANSFORMER
List \$11.00
Special \$7.50

IMPORTANT NOTICE!

OUR STOCK OF King - Cardwell 41-plate Condensers is entirely SOLD OUT. We offer, as substitutes, Rathbun 43-plate Condensers, \$1.00; Federal 43-plate Condensers, 95c; Kellogg 43-plate Condensers, 75c.

RCA UP-1016 POWER TRANSFORMER
List \$38.50
Special \$11.50

MINIATURE LAMPS
15c

RCA UP-1056 Filament TRANSFORMER
75-Watt
List \$15.00
Special \$5.50

Radio Blinker Practice Set

Ideal for learning the code. Equipped with both a high frequency buzzer and a blinker light, either of which may be switched on for practice.
SPECIAL, \$2.95.

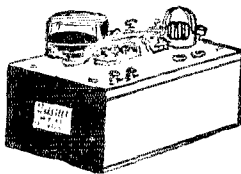

BUZZERS



Desirable for testing crystals and for practicing code. Gives a sound nearly resembling C. W.
SPECIAL 75c

TELEGRAPH KEYS

Solid silver contacts; made to sell for \$1.75.
SPECIAL 49c

NAVY RECEIVING TRANSFORMER

Covers the wave-length band up to 350 meters. List, \$12.20.
SPECIAL \$3.75

CARDWELL CONDENSERS

King-Cardwell Transmuting Condenser. Factory rebuilt for 5000 volts, \$2.95.

King-Cardwell 11-plate Condenser. Special, 95c

King-Cardwell Dual Condenser, 15-16 plate, \$1.95. 11-11-plate, \$1.50.

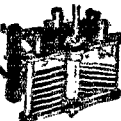

WRITE FOR OUR HAM LIST and B.C.L. BARGAIN BULLETIN

RADIO SURPLUS CORP.

250 WASHINGTON ST.

Boston

Massachusetts

FOR YOUR CONVENIENCE QST'S INDEX OF ADVERTISERS IN THIS ISSUE

Acme Apparatus Company	89
Acme Wire Company	62
Advance Electric Company	80
Aero Products, Inc.	84
Aerovox Wireless Corp.	82
Allen-Bradley Company	66, 80, 84
Aluminum Company of America	59
Allen-Rogers, Inc.	86
Amateur Radio Specialty Company	70
American Sales Company	74
American Transformer Company	82
Amrad Corporation	82
A.R.C.L. Handbook	3rd Cover
Barawk Company	88
Browning-Drake Corporation	87
Burgess Battery Company	4th Cover
Burton-Rogers Company	76
Cardwell Mfg. Co., Allen B.	96
Carter Radio Company	78
C. E. Mfg. Company	72
Central Radio Labs.	76
Crescent Radio Supply Company	84
Coslow Radio Corporation	82
Cummins, Inc., E. T.	2nd Cover
DeForest Radio Company	83
Deussen Co., Tope	93
Donnan Elec. Mfg. Company	82
Dudlo Mfg. Company	71
Eastern Radio Institute	74
Electrad, Inc.	68
Electric Specialty Company	67
Electron Relay Company	62
Elkon Works, Inc.	79
Ensell Radio Lab.	88
Empsteel Products Co.	80
Everatt, Inc.	66
Fortuna Insulation Co.	75
Frost, Inc., Herbert H.	78
General Radio Company	69
Geyer Company	90
Grebe & Company, Inc., A. H.	4
Gulf Radio School	88
Halco Mail Order Service	60
Hammarlund Mfg. Company	70
Hammarlund-Roberts	86
International Resistance Company	86
Jewell Electrical Instrument Co.	78
Kokomo Electric Company	90
Lynch, Arthur H., Inc.	60
Loomis Publishing Company	86
Marlo Electric Company	83
National Carbon Company	95
National Company	85
New Jersey Radio Supply Company	62
Pacnet Electric Company	93
QST Back Copies	74
QST Bound Volumes	68
Radio Corporation of America	1
Radio Engineering Labs.	65
Radio Institute of America	64
Radio Surplus Corporation	90, 94
U.S. Sales Division	81
Sanzano Electric Company	72
Scientific Radio Service	64
Signal Electric Mfg. Company	64
Silver-Marshall, Inc.	84
Smith, B. Hawley	66
Stirling Mfg. Company	86
Stronberg-Carlson Tel. Mfg. Co.	63
Thordarson Elec. Mfg. Company	77
Transmuting Equipment Company	72
Ultimate Transmitter Company	76
Urbilly Radio Company	66
Vibroplex Company	64
Ward Leonard Electric Company	68
Well's Curiosity Shop	84
Weston Electrical Instrument Corp.	74
Wireless Specialty Apparatus Company	61
X-L Radio Labs.	62
Vaxley Mfg. Company	60
ZMA	93

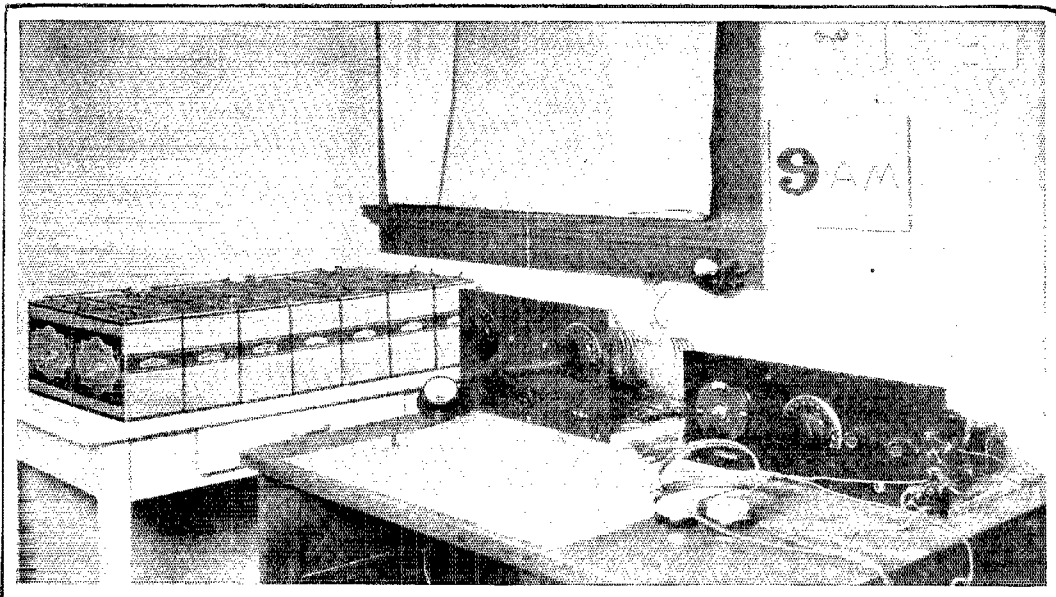

You'll handle more traffic on pure DC

STATION 9AM, owned and operated by J. L. Adams, Glencoe, Illinois, represents simplicity and efficiency from the ground up (HI).

The transmitter is the familiar inductive coupled Hartley. A Pyrex socket holds a UX-210; the plate current supply is from a bank of fourteen Eveready Layerbilt "B" Batteries, delivering 630 volts of pure DC.

Shortly after the transmitter was completed, tests were carried on in the heart of Chicago using a thirty-foot horizontal antenna, strung through an apartment building, using a radiator for ground.

During these tests nearly all reports from the East, as far as New Hampshire, were R7 and R8. Stations on both coasts and North were worked during these tests. Southern stations, however, were nil.

This work was carried on in the middle of summer under all weather conditions. Some of the best contacts and best DX were accomplished during heavy electrical storms. The percentage of contacts ran astonishingly high during these indoor tests. As a result of these experiments and later ones, 9AM has become a confirmed believer in dry cell "B" batteries for low-power

transmitters. Witness the bank of Eveready Layerbilts on the table in the photograph.

The success of these tests was undoubtedly due to two things in the main—the pure DC plate supply and the simplicity of the Hartley Circuit. The transmitting amateur will almost invariably stop on a pure DC note, because of its readability, its ability to penetrate heavy QRM and QRN and its pleasing tone.

Inasmuch as this layout is located in a kitchen, pure DC plate supply is absolutely necessary to keep that frying noise out of the emitted note (HI HI).

Eveready Layerbilt "B" Battery No. 486, 45 volts, is being chosen by a steadily increasing number of BCL's as well as amateurs. We know of no battery that gives longer service.

Manufactured and guaranteed by
NATIONAL CARBON COMPANY, INC.
 New York San Francisco
 Canadian National Carbon Co., Limited, Toronto, Ontario

Tuesday night is Eveready Hour Night—9 P. M., Eastern Standard Time, through the WEAFF network stations

EVEREADY
Radio Batteries
—they last longer

Cardwell

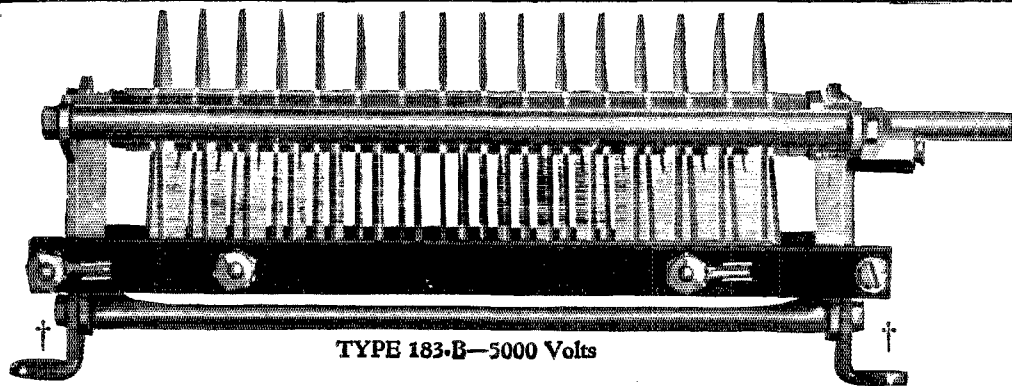

TYPE 183-B—5000 Volts

~ NEW RATINGS! ~

THE Voltage Breakdown ratings previously published on CARDWELL Transmitting Condensers have proven somewhat confusing to many users, so for the convenience of the Amateur Fraternity, we make these recommendations for primary and Antenna Tuning Condensers.

FOR 5, 7½, 15 and 50 WATT TUBES

With plate voltages of 800 or less, C. W., or with plate voltages of 600 or less, I. C. W. or Phone.

141-B	.00025	\$4.25
123-B	.0005	5.00
137 B	.001	7.00
156-B	.0005*	7.00

FOR "H" and 50 WATT TUBES

With plate voltages of 1500 or less C. W., or 1100 or less, I. C. W. or Phone.

164-B	.00022	\$7.00
147-B	.00044	10.00
157-B	.00022*	12.00

*Two sections—capacity of each.

FOR 250 WATT TUBES

With plate voltages of 2000 or less, C. W., or 1500 or less, I. C. W. or Phone.

183-B (Improved)	.00015	\$16.50
For Larger Power		
166-B	.0003	70.00

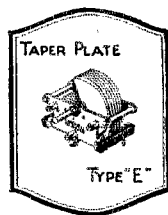

The TAPER PLATE TYPE "E"

Type	Capacity Mmfd.	Price
191-E	75	\$3.75
167-E	150	4.00
168-E	250	4.25
169-E	350	4.75
192-E	500	5.00

† Mounting Feet, 25c per pair. Sold Separately.

The Allen D. Cardwell Manufacturing Corporation

81 PROSPECT STREET

BROOKLYN, N. Y.

Condensers

"THE STANDARD OF COMPARISON"

To the Man Who Would Like to be an Amateur and Doesn't Know How to Start—to the New Recruit to Short-Wave Radio.

Here is a book written to order for you, to tell you how to do these things

It starts at the beginning and tells what an amateur is,
what the League is,
what amateur radio is,
how to be an amateur,
how to learn the code,
how to understand what you hear,
how to get your licenses,
how to build a simple station,
how to build a better station,
how to operate your station,
how the A. R. R. L. works,
how to handle traffic,
and it winds up with an appendix filled with enough extra dope to keep you busy for the next ten years.

It has twice as many words as the average book, all of them directed right at you and your case.

The name of this book is
THE RADIO AMATEUR'S HANDBOOK
and the price is only \$1, postpaid

American Radio Relay League
1711 Park Street, Hartford, Conn.

QRT

Stop sending your calls! This space which Burgess Battery Company has

DEVOTED ENTIRELY TO AMATEUR RADIO

stations in which Burgess Batteries are used does not provide sufficient space to list them all on this back cover of QST which is

Published by the American Radio Relay League

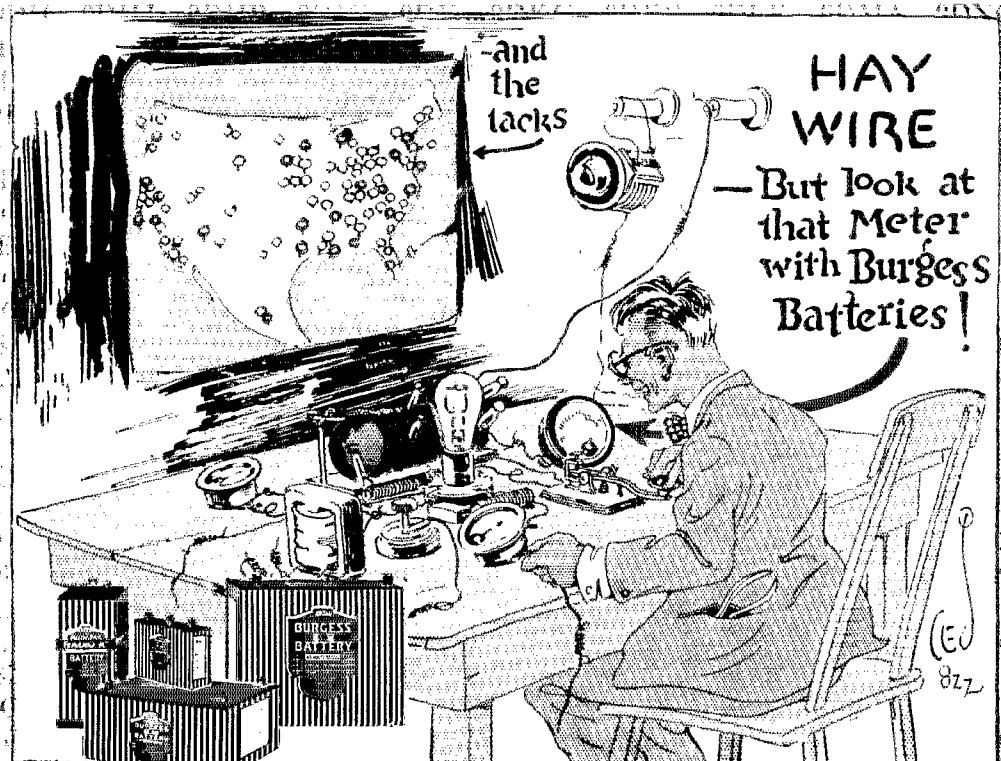

and
the
tacks

HAY WIRE

—But look at
that Meter
with Burgess
Batteries!

FEBRUARY
1927

73

The Communications Department

F. E. Handy, Communications Manager
1711 Park St., Hartford, Conn.

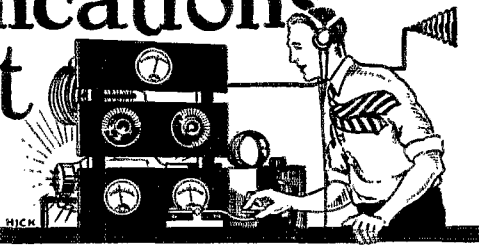

Abbreviated Standard Procedure

Standard procedure brings uniformly good results. That is why we have it. Some of the high men in the B.P.L. are forced to adopt abbreviated standard procedure to meet competition and hold their places, however. It is quickest to use standard practise when working a rank beginner because one will otherwise have to stop and explain the harder-to-understand abbreviated procedure in detail.

While for ordinary message-handling work, standard procedure will insure that everyone understands what you say and do, we will mention the abbreviated procedure in passing in the interest of brevity on the air and so that you can understand what is meant when you hear some high speed stations working together. In handling lots of messages with a number of scheduled stations most stations can be cleared by holding all stations to 15 minute schedules and having a bunch of schedules in consecutive order. To get several messages through in 15 minutes isn't an easy job but the following practises have helped to cut down unnecessary transmission to some extent and have been adopted by the Maine Message Pushers' Club to help in bettering the state-wide organization and in keeping the gang in the B.P.L. consistently.

1AUF nulBMS P, meaning paid, personal, or private message (adopted from commercial procedure) is much quicker than HR MSG appended to a call. N QSU is shorter than QRU CU NEXT SKED. 1BIG keeps the correct order of the preamble given in the R. & R. but instead of saying HR MSG FM AUGUSTA MAINE 1BIG NR 156 OCTOBER 13 CK 14 TO etc. he saves transmission by using RDO AUGUSTA ME 1BIG 156 OCT 13 14 to etc. Another thing that conserves operating time is to cultivate the operating practise of writing down 156 1UE 615 p10/13/26 with the free hand during the sending of the next message. It is hard to do at first, but all these little points added together make the total time saved on a message mean something.

QRP-QSO Tests for 20-Meters

The T. & R. Section of the Radio Society of Great Britain announces further tests to be held daily during the month of February. Efforts to establish two-way communication with as many stations as possible will be concentrated on Saturdays and Sundays particularly, when most station-owners can spend all their time operating the set.

The eg's (English amateurs) will operate on 23 meters (13,000 KC's) using a maximum power not exceeding 25 watts which preliminary tests indicate is ample. nu's (U. S. A. amateurs) will use the 18.7—21.4 meter wavelength band (14,000-16,000 KC's). The T. & R. Section is endeavoring to make the test an international one. Countries not licensed for 20-meter work will of course have to work on the nearest wavelength. Times of daily tests: 1800-2000 G.M.T. (noon—2.00 p.m. Central Standard Time).

Please take part in these international tests if possible, OM. Reports giving full details regarding stations HEARD or WORKED on 20-meters during the tests should be sent to A.R.R.L. Headquarters, 1711 Park St., Hartford, Conn. A complete report will be compiled and forwarded to the T. & R. Section and if of general interest the results will appear in QST. It's up to you OM, so please put over our end of these tests in typical A.R.R.L. fashion.

Traffic Briefs

6RV recently handled a lot of football traffic working 6DBL in Hawaii both night and day while the Utah football team was playing in Hawaii. Local fans were able to keep in touch with the progress of the game. They and their friends in the Hawaiian Islands also were given the opportunity of extending greetings via radio without the delays introduced by using mail or telegraph service. One more instance of the service given the public by amateur radio operators and their stations. FB, OM! Let's hear of more good work like this, fellows.

6EI is a new YL-station at Long Beach, California. Miss Edith Haddock has just received her "ticket" and is now operating at 6BZL, owned by Jack Farmer to whom she is engaged. The two 7½-watters get out in fine shape on 40-meters. Miss Flora Turner, 6BXA, is the other YL helping to roll up the traffic totals for Southern California. The New England Division still claims the honors with 1KY and 1AID both in the Brass Pounders' League, but it looks as though there was going to be some competition from the Pacific Division. What do the other Divisions think about it?

The Amateur:

—HIS CODE

- I *The Amateur is a Gentleman.* He never knowingly uses the air for his own amusement in such a way as to lessen the pleasure of others. He abides by the pledges given by the A.R.R.L. in his behalf to the public and the government.
- II *The Amateur is Loyal.* He owes his amateur radio to the American Radio Relay League, and he offers it his unswerving loyalty.
- III *The Amateur is Progressive.* He keeps his station abreast of science. It is built well and efficiently. His operating practice is clean and regular.
- IV *The Amateur is Friendly.* Slow and patient sending when requested, friendly advice and counsel to the beginner, kindly assistance and cooperation for the broadcast listener: These are marks of the amateur spirit.
- V *The Amateur is Balanced.* Radio is his hobby. He never allows it to interfere with any of the duties he owes to his home, his job, his school or his community.
- VI *The Amateur is Patriotic.* His knowledge and his station are always ready for the service of his country and his community.

—PAUL M. SEGAL

Here's an interesting bit of amateur cooperation. On the day before last Thanksgiving, 6BXI was QSO with o23AL. An American citizen in New Zealand had asked 3AI for our President's Thanksgiving Proclamation. In response to 3AI's request, 6BXI located a copy of the Proclamation and sent it single to 3AI, the whole transmission taking an hour and a quarter. A perfect copy was received at the New Zealand station, and the Proclamation read at a meeting then in progress there. Fine work, OMs!

6BMW, Route Manager, would like to hear from stations desiring schedules especially for P. I. traffic. Be sure and include all dope as to wavelength, etc., when you write.

How's this one, gang? Not so long ago, 1BCY of Camden, Me., sent a message to 1BIG of Augusta, asking for a Pullman reservation on a certain train out of Augusta. 1BIG immediately called up the Maine Central Operator, and made the reservation, after which he sent a return message to 1BCY, giving the location of the reserved berth on the train. The whole affair occupied only three minutes of time.

Much has been said already about operating off wave, yet it is still being done consistently by a surprising number of stations. Most of them are on the low side of the forty meter band, thereby interfering greatly with foreign DX. Why must you do this, fellows? It isn't necessary, and you'll get just as good work out of the old set if you'll just come up into the proper bands. Let's see if we can't have 100% operation within the proper bands from now on.

The present expeditions that are out are not heard from a great deal—at least not by most of us amateurs. The Abyssinian expedition (BAUM) has not been forced to use short-wave radio thus far as it is just starting its plunge into the uncivilized portion of Africa. The low power set is there for use just the same so it is up to amateurs everywhere to keep an ear open for the call so we can cooperate when needed. The Dvoit-Roosevelt expedition (GMD) is still in the South American wilderness keeping contact with NKF on 40-meter schedules at certain specified dates. Operator Perkins has returned to this country on account of his health. Bussey is having good luck in getting through to NKF regularly using the low-power set with just one "fiver".

The prospects for a lot of expedition work in the near future are mighty bright, tho. A number of expeditions with high power transmitters for general amateur contact are getting ready to start out in the early spring. The MacMillan party (WNP) will undoubtedly make its annual trip. The Putnam expedition (VOQ) is going up again and we are sure there will be some of the gang behind the key that you have heard before with an amateur call. Howard Mason (7BU) tells us that he is going to Point Barrow with the Wilkins Arctic Expedition (KFZH) as soon as February 12—so keep an ear out for 'em all, gang. There will be more dope in later QST's. Better start tuning up the old set if everything isn't in A-1 condition so that nothing will slip when you have a chance to grab some important traffic from the far parts of the earth.

3BWT recently QSO'd oh6AXW and "SQ" took 19 messages direct. Speaking of 3BWT, some statistics on the operation of this Official Relay Station during 1926 may be of interest. Three transmitters were kept in operation using 178, 82, or 39 meters as desired. An average of four daily schedules was kept. Perhaps the most consistent one is that kept with 3EU daily which hasn't missed once since the last Governors' President Relay. Getting on with the statistics—48 states, 5 Canadian districts, and 15 countries were worked, 2484 messages handled, and 1624 separate and distinct QSO's made. 3BWT has six regular ops, Eppa W. Darne, "Ed" being both owner and operator. The other ops have stations of their own but may be known by their personal "sines" when behind the key at 3BWT. They are Frank Dunan, 3NR "NR"; M. W. Downes, 3WT "Reds"; W. E. Grant, 3IO "SQ"; R. E. Banker, 3BHV "BK"; Earl Merryman, 3ACM "AC"; H. F. Sheehan, 3CHC "CC". Operating costs aggregate some \$700, the principal items being for replacements and new apparatus. Nearly 2,000 kilowatt hours were burned up in keeping the station on the air and the correspondence handled reached the surprising figure of \$67 because

this station lives up to the motto, "We always QSL." 3BWT is a reliable QSR point and always QRV for your traffic for Washington and points with which scheduled contact is maintained. Need we say more!

3AWT suggests that it will have time in asking for QRA's, if more operators will adopt a personal sign made up of their two initials and USE it. When a personal sign is used in agreement with the name in the call book, it indicates nine times out of ten that mail addressed to the call book address will be delivered or forwarded to the man worked. If the personal sign is not in agreement with the call book, one can then take steps to find out what operator is on at the station worked, getting the correct address if necessary. The only time when a personal sign will not indicate the name in the call book is when the call book is wrong, or when a station is operated by a staff of several operators.

Perhaps the most northern amateur radio station is 8AZS (Stanley W. Brazil, Battle Harbour, Labrador.) Using one 250 watt supply by a generator driven by a 4 H.P. gas engine, 8AZS gets out well on 41.5 meters. Four schedules a week are kept with nc8AR. WNP has been worked regularly. A schedule is being arranged with nc1DD.

2RV has been operating on a steamer running from the U.S. to European ports. 2ANM worked him regularly for two trips straight about all the way to the Suez canal

WWDO is the U.S.S. Cedar, a government supply ship for Alaska operating on about 82 meters wavelength. 6NO (88m.) has been QSO several times making some tests. It was found possible to work WWDO in Alaskan waters at 11 a.m. over the 2,000 miles of ocean, though of course the signals were not so good as when usually worked at night.

NIJX is the U.S.S. Gannet, the tender ship of the Alaskan Aerial Survey Expedition. A receiving tube with 350 volts on the plate is used on 84.7 to keep in touch with the base station (7BH) located at Juneau, Alaska. 6BJX worked NIJX, handling a number of messages addressed to members of the expedition on the Gannet while they were near Sitka, Alaska. Though signals may have been heard over greater distances on lower power than this, it is not at all bad traffic-handling work for a receiving tube.

9CKS worked VYG a number of times when she was unable to make scheduled contact through nc2CG. Among acknowledgments of messages delivered was a letter stating that the message represented the second word one family had received from the sender, a Northwest Mounted Policeman in the Arctic in two years. 9CKS says it makes a fellow feel good to help like this.

To Lieutenant Haydn P. Roberts, op1HR, goes the credit for some most energetic organization work in the Philippine Islands. As a result of his activity there is now in operation a Philippine Section (provisional) of the Pacific Division of the A.R.R.L.

6BUC, the station of the Radio Club of Hawaii, is keeping two schedules with the Philippine Islands regularly. Contact can be established at any time without difficulty. The amount of traffic handled between Hawaii and the Philippine Islands is merely a question of the number of messages originating in the Philippines and the number relayed from the Coast to Hawaii for re-handling to the Philippines.

7IT, the SCM of Oregon, recently made use of amateur radio to connect Mr. Baldwin, his father's business partner travelling on business in New Zealand, with his business associates in Portland, Oregon. Several messages were handled by o2IAO at Auckland who kept consistent and reliable schedules and who hoped to give the business men on both ends of the circuit a kick out of some direct radio conversations with New Zealand. Unfortunately, Mr. Baldwin had to make his headquarters at Wellington so the work could not be carried out as planned by o2IAO because Mr. Baldwin could not

come to the radio station. However, oz1AO deserves much credit for his willingness to help and his good sportsmanship when he found that things could not be pulled off as first planned. Direct contact was established finally through Mr. Shrimpton and his son of oz2XA located at Wellington. On August 15 at least 500 words of actual messages and a quantity of calls and conversation were handled by 7IT and oz2XA sending double but without a single repeat. Next morning, a 775 word business message was put through bad static and jamming in three hours and a half working time. Since then some other long messages have been handled sending single (with a few repeats) when conditions were better. Traffic is still being handled on a regular schedule. Good operators and good stations are rolling up a good communication record under adverse conditions. Amateurs the world around are right on the job whenever there is an opportunity to be of service!

7YC is the station of the Seattle Y.M.C.A. School of Radio Telegraphy, operating on 40 meters. Several operators keep the station on the air afternoons and four evenings a week until 10 P.M. Route your traffic to Seattle, Washington, via 7YC to insure prompt deliveries.

The QRA of FI-1 is Fort Ruger, Territory of Hawaii and the station at present operates on a 41 meter wavelength.

Dick Chase, ex 1KX, 1AXQ, ADM, ADPM, and DS in Maine is now in Colorado Springs, Colorado. He writes that it is impossible to quit the amateur game. He tried to sell his apparatus and forget amateur radio forever but the bite was too deep. Now he is taking steps to get a new outfit on the air and will probably sign 9BUG. A good call for such a dyed-in-the-wool amateur as Dick!

Roebuck operator of KFUH, is on his way from Honolulu to New Orleans on the S.S. Volunteer of the American Pioneer Line. Some of the gang will get some interesting information on their signals if they get in touch with Roebuck before his return to Honolulu.

nc9AI and nc9AQ, the stations of the Hydro Electric Power Commission of Ontario, located at Toronto and Hydro (near Cameron Falls, northeast of Port Arthur) respectively, are licensed to operate on all amateur waves as well as on their own waves of approximately 30 and 50. Permission has been granted for the operators (nc3FC and nc3HP) to handle A.R.R.L. traffic at any time when the operator is not busy with Hydro business. A quarter K.W. tube is operated from a motor-generator supply using the regular Hartley circuit at present but the sets may be changed to crystal-controlled operation later in the season. nc3FC sent us a message from nc9AI recently via 1BVR stating that the station was using horizontal wave propagation and a wavelength of 38 meters for amateur work.

Every station owner or QST reader contemplating the installation of an amateur radio station should obtain a copy of the booklet *Safety Rules for Radio Installations* (Handbook of the Bureau of Standards No. 9) comprising Part 5 of the National Electrical Service Code. This can be obtained from Superintendent of Documents, Government Printing Office, Washington, D. C. for ten cents (stamps not accepted). The new rules for installing grounding switches, putting up antennas, bringing lead-ins into the house, clearance distances of antennas above streets, and driveways or below telephone and power wires, and so on are given in full and the booklet is invaluable as a guide to be followed in making changes in the station or putting up a new outfit. Better send for it now, O.M., and see if your outfit is O. K.

8ATX recently worked HK3Z (somewhere in China) who asked that the gang listen for him each Friday morning (2 to 7 E.S.T.) on 80.7 meters wavelength. HK3Z also tests at this time on 7.5, 10, 17 and 22 meters. All reports or requests for information on this station should be sent care of 8ATX.

BRASS POUNDERS' LEAGUE

Call	Orig.	Del.	Rel.	Total
1AAP	501	127	372	1018
1BMM	482	41	325	848
1OC	47	240	568	780
1ATJ	23	29	598	649
6AMM	50	94	416	560
9DTK	46	54	428	528
8VZ	263	156	62	481
9EK-XH	195	197	84	476
1BIG	46	66	322	434
7JF	50	77	278	405
1BVB	114	27	255	396
8ADQ	193	58	132	383
9DXY	37	36	301	374
8EU	34	64	250	350
6ZBJ	76	16	236	331
1BFZ	70	33	220	323
8DNE	70	4	248	322
6BJX	76	116	124	316
9CZC	3	10	301	314
1MK	129	90	94	313
3BWT	86	56	170	312
1BLW	16	14	280	310
9CAA	20	38	255	310
6ANO	31	2	270	303
1YS	243	8	50	301
1AIT	7	35	346	288

2ABF 287, 9BKV 284, 2CYX 282, 1UB 270, 1NK 266, 8XE 245, 2ANX 240, 1BMS 235, 3AWT 238, 1AJM 230, 6BHI 230, 8CGZ 226, 1EB 228, 1AOQ 222, 7YA 222, 9DWN 220, 6AXW 217, 8BVR 216, 4DD 210, 8AVK 210, 6AJM 209, 9GL-DCJ 204, 1ATV 202, 2AT 200, 1AID 187, 8ADE 181, 1HB 176, 5AMO 175, 4BL 174, 9APY 172, 5APO 172, 8DED 171, 1JL 168, 9EBL 168, 1LM 167, 3CAB 164, 2AWU 160, 4AOH 158, 6RV 157, 1ADL 156, 7ABB 155, 6RJ 155, 6ABM 154, 1AVL 150, 6BQ 148, 6PV 147, 9AED 145, 4OB 143, 3AB 143, 1AOX 142, 8BBL 141, 2QH 140, 2BCB 138, 8AKC 138, 6BVG 135, 6ALZ 135, 2AVB 135, 2AKR 135, 5ANL 135, 9DOE 134, 6AZS 134, 6CKV 133, 9ZK 133, 8DSY 133, 1BYV 133, 9CAJ 133, 1AQL 131, 9BWN 131, 8CEP 130, 8CWT 130, 1BKV 130, 1BHM 129, 8CWK 128, 1KY 126, 2AMX 126, 3AIG 125, 2ADH 125, 9DGR 124, 2AVR 121, 8GI 120, 1DI 119, 2IS 119, 9BIB 119, 9CSB 117, 1XM 117, 5APG 116, 6CYH 116, 6BXD 116, 2CLA 116, 2AML 115, 8AGI 111, 7AAT 111, 9BWJ 111, 6CCO 110, 8CBO 110, 6RW 109, 6BYH 108, 8AUB 108, 8GZ 107, 9EQJ 107, 1IP 107, 3BLP 106, 1AAL 106, 9QD 105, 8AHC 105, 8AVB 105, 1FP 104, 7PU 103, 8VE 103, 8BAH 103, 4MI 102, 2DY 101, 9BXT 100.

The honor roll of brass-pounders took another jump this month—so that we are obliged to list the 25 highest stations first, closely followed by all the others that piled up totals in excess of the 100-messages-per-station mark. 1AAP originated quite a bunch by virtue of which he leads them all this time, quite a number of others competing with him for first place however. The stations that undertook the responsibilities of making deliveries and boosting two-way citizen radio traffic locally deserve special credit for their efforts. It is a favorable sign when in a number of cases the "delivered" column in a report shows a higher figure than the "originated" column. Every station in the list is a real good traffic station and the owners and operators have reason to be proud of their performance. Some districts seem to stand out above the others by virtue of having a greater number of traffic men with a place on the honor roll.

Sept. 21, 1924 was the date of the first two-way QSO with New Zealand (6BCP-z4AA). This year the active San Pedro station owners decided to remember the anniversary by working as many stations in Australia and N. Z. as possible. Most of the stations in the city were closed during the summer but three were put on the air at short notice. 6BOL, 6CUA and 6CWK clicked with z4AC, a2SH, and a4BD during the 21st and got considerable mention in the local papers for their stunts. All the San Pedro gang cooperated in the usual fine shape to put over the publicity stunt for the good of amateur radio.

WITH THE ROUTE MANAGERS

Route Manager work is progressing rapidly. Some very fine complete reports have been coming in during the month, and we hope for more next time. Following is a list of schedules of regular operation gleaned from reports of three RMs:

CONNECTICUT—C. B. Weed, 1BHM, R. M.:			
New Haven	8 AM—noon daily		41.3m.
1AUK	5-7 PM Sun.	11-12 PM daily	80m.
1BQH	6-8 PM daily.	Sun. afternoons	37.5m.
1BJK	7-12 PM daily		40m.
1CTP	8-10 PM daily.	Sun. afternoon	79.8m.
1BAU	12-1 PM daily.	5:30-6 PM daily	38m.
1BHM	Sunday afternoons		20m.
COLORADO—T. E. LaCroix, 9DKM, R. M.:			
Denver	6-8 AM and 6-8 PM daily		38m.
9DKM	5:30-8 PM daily ex. Sun.		39m.
	6:30 AM Sun.		39m.
9DSY	11:00 AM-1 PM daily		39.5m.
9AAB	7-8 PM daily		30m.
9CHV	8-10 AM daily ex. Mon.		39m.
9CAA	6:30-7:30 PM daily ex. Thurs.		33m.
9EAM	10-12 PM daily		80m.
WESTERN MASSACHUSETTS—R. S. Brown, R. M.:			
Chicopee	5-6 PM daily		42m.
1AAC	6-8 PM daily		35m.
Greenfield	8-10 PM daily		41m.
1AOF	7 PM daily except Sat.		76m.
	10:30-12 PM daily		30m.
Pittsfield	6-8 PM daily		39.5m.
1AZW	10:30-12 PM daily		30m.
LARE	6-7:30 PM Mon., Wed., Thurs.		78m.
1AAE	5-7:30 Sat. and Sun.		78m.
1AZD	6-8 PM Sun., Mon., Wed.		79m.
Springfield	7-8 PM daily		78m.
1EO	6-8 PM daily		79m.
1APL	6-8 PM Sun., Mon., Wed.		79m.
1AWW	6-7 AM Thurs., Fri., Sat.		39m.
Worcester	10:30-12 PM Tues., Thurs.		80m.
1AAL	5-8 PM daily		40m.
1AJK	10:30-12 PM daily		80m.
1ASU	10:30-12 PM Mon., Wed., Fri.		80m.
1BIV	10:30-12 PM Mon., Wed., Fri., Sat.		80m.
1DB	10:30-12 PM Tues., Thurs., Sun.		40m.
1GR	6-7 PM daily		40.32m.
1YK	10:30-12 PM daily		79m.
1JV	10:30-12 PM Fri., Sat., Sun.		50m.

CLUB ACTIVITIES

CALIFORNIA—The Santa Clara County Amateur Radio Association has installed an automatic tape transmitter for code practise, as well as a new low power transmitter for use until the higher power one is completed.

The Western Amateur Radio Association is doing fine work in interesting BCLs in amateur work, and hopes to get several new brass-pounders before long. 6CKC, 6BHX, 6BAA, 6TS, 6AUY, 6BFU, 6NZ, 6IM, 6CTX, and 6AHG put over PB comedy skit at the recent Pacific ARRL Convention at San Jose.

ILLINOIS—The Chicago Radio Traffic Association held a hamfest at Chicago, which was attended by guests from several miles around. Many interesting speeches were followed by some acrobatic stunts by 9CMR and 9FP. 9LY and his committee were mainly responsible for this enjoyable get-together. The New Trier Radio Club of Kenilworth, Ill., has been holding regular meetings at which interesting lectures have been given. They expect to be on the air shortly.

MASSACHUSETTS—The Springfield Radio Association has completed its new building, and is commencing work on a transmitter. 1BSJ is the one who first planned on the club's owning its own transmitter, and is the instructor of the Association. Completion of the transmitter is expected within a month or two.

MONTANA—The Butte Radio Club is coming on the air, and expects to hold an ORS certificate soon.

NEW JERSEY—At a recent meeting of the South Jersey Radio Association, the mother of one of the active boys made a wonderful cake, which, needless to say, helped to make possible a real, bang-up meeting.

NEW JERSEY—The Raritan Valley Radio Club is a new organization at Somerville, N. J. Membership is quite large and growing rapidly.

NEW YORK—The Radio Club of Brooklyn has changed its location to the Erasmus Hall High School. All transmitting amateurs of Brooklyn are invited to write to the Secretary, Mr. D. F. Kay, 323 Eastern Parkway, Brooklyn, for information regarding the activities of the club.

NORTH CAROLINA—The Charlotte Amateur Radio Association recently elected 4UQ, 4CQ-WBT, and 4OE, as its officers for the coming year.

SOUTH DAKOTA—The Sunshine Radio Club of Platte, and the YMCA Radio Club at Sioux Falls are doing fine work. The membership of both clubs is growing, and activities are being planned.

Several other R. Ms sent in good complete reports, but rather than listing times of regular operation, they listed actual schedules with other stations. This is fine information, and can undoubtedly be used to advantage, but for the present what we want is the kind of information shown in the above reports. The map accompanying this article has been made up from maps sent in during the months by RMs. It has been purposely distorted to a degree in order

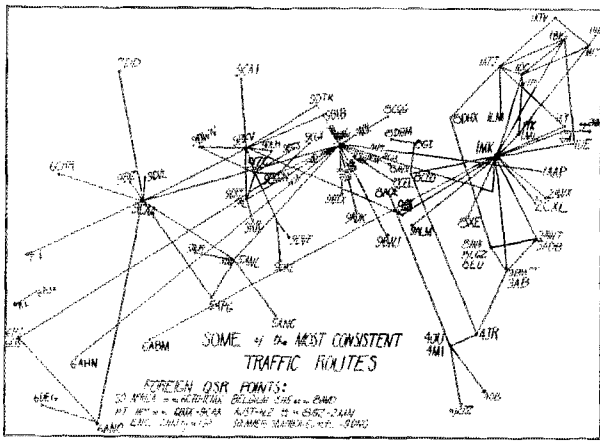

Darling, I am growing old
 'Nammed strands among the gold
 When your grid turns up its toes
 And your plate no longer glows
 Then with gusto I will sing
 Of the feats DX cards show
 Yes, my darling, you will be, will be
 Always pure DC to me
 And your records I will keep
 In that shack where KC's leap.
 —L. W. MacLellan, 1HZ.

One incident of amateur cooperation must be mentioned as showing the ability of amateurs to fill the needs of almost every situation that comes up in the course of station operation. 4AAM in Charleston, S. C., rates the credit this time. While QSO with WVR, the government station at Fort MacPherson, Ga., 4AAM learned that WVR wanted to connect with NAO (located half a block from 4AAM). As the difficulty seemed to lie in the fact that NAO could not hear WVR, 4AAM phoned NAO telling the operator to follow the heterodyne squeal of his receiver until he got WVR's wavelength when he would cut off his receiver. This plan worked nicely so that the government stations hooked up for traffic handling without further difficulty. Congrats and PB on the fine work 4AAM!

to get as much information as possible in as small a space as possible. So don't worry if you find yourself located in a different part of the country than you thought you lived in. Before long RMs will have been appointed for all

NOTICE!

TRAFFIC BRIEFS

Nominating petitions for Section Communications Managers are hereby solicited from the following Sections:

Section	Petitions to be valid must be filed on or before
Alaska	Noon, March 2, 1927
Montana	Noon, March 2, 1927
Oregon	Noon, March 2, 1927
Washington	Noon, March 2, 1927
Sacramento Valley	Noon, March 2, 1927
Los Angeles	Noon, April 2, 1927
San Francisco	Noon, June 2, 1927
San Diego	Noon, Feb. 2, 1927
Hawaiian	Noon, Feb. 2, 1927
New Mexico	Noon, March 2, 1927
Manitoba	Noon, March 2, 1927

The closing dates for receipt of nominating petitions in the Sections listed is given above either as previously announced or extended when necessary due to the failure of members in filing petitions in certain Sections. Petitions must be filed at A.R.R.L. Headquarters on or before the time announced to be valid. The proper form for nomination was shown on page 45 of April 1926 QST. The candidate and five signers of a nominating petition for Section Communications Manager must be members of the A.R.R.L. in good standing and the signatures on the petition must be authentic or the petition will be thrown out as invalid. Members are urged to take initiative immediately, filing petitions for the officials of each Section now operating under temporary officials, so that the work of organization can go forward everywhere without further delay.

—F. E. Handy, Communications Manager.

ARMY-AMATEUR NOTES

1ST CORPS AREA—1APM is operating at Headquarters in Boston, and works a schedule with 2CXL once a week. This station along with 1YC and 1SL is working in the Army Net every Monday and Friday night.

2ND CORPS AREA—8HJ, the N. C. S. of the Western N. Y. Net, sends out a mimeographed bulletin to all the A. A. Stations in his net every month. 8AX, 8ANX, 8CPG, 8DME, 8BHM, 8VW, and 8HJ are the most active stations, and keep schedules Monday and Thursday nights. 2ASE is arranging schedules for the Eastern N. Y. Net, and also sending out mimeographed bulletins. 2CYX N. C. S. of the Bronx Net, and 2APV are keeping schedules regularly. 2CYX wants all Bronx stations interested in A. A. work to write to him. 2EV has resigned as the N. C. S. of the Manhattan Net, and is succeeded by 2ANX. 2APD, 2ARM, 2AVR, 2AND, and 2PF are the most active stations in the Brooklyn-S. I. Net, keeping schedules every Wednesday night. 2AFV is a new A. A. Station in S. I. 3HW, the N. C. S. of the N. J. N. G. Net has been very active. Schedules for the N. J. Auxiliary Net are kept by 2KS, the P. N. C. S. The regular monthly meeting of A. As was held at N. Y., at which Mr. Ross A. Hull of Australia gave a very interesting talk. All Net Control Stations are requested to submit their monthly traffic reports promptly on the last day of the month to 2SC.

3RD CORPS AREA—Army Amateur Stations are still needed in Annapolis, Md., and Harrisburg, Pa. Signal Corps station 3SN is the N. C. S. of a general net organized in this Area. Schedules are maintained with 2CXL, with 3BOG as alternate. Amateurs interested in the above schedules are asked to write to 3SN.

5TH CORPS AREA—Capt. Gardner of Fort Hayes, who has been in charge of the A. A. work, has been assigned to a new position in Washington, D. C., and Capt. Glessner, from Fort Monmouth, N. J., has been assigned in his place. 8GZ, the N. C. S. and 8BYN are cooperating to get things in this area running smoothly again soon. 8DPT, of the 37th Signal Co., Ohio National Guard, will be on forty meters soon, with crystal control. Nets are being formed. Any one interested is requested to write to 8BYN.

QST FOR FEBRUARY, 1927

6BJX still holds the fort with his regular Philippine Island schedule—15 months of it and still going strong. Conditions have been rather poor, making QSZ necessary. The Christmas rush made up for previous slack traffic for the Philippine circuit that has been kept in operation so reliably. op1HR and 6BJX batted out the holiday messages at a rate of about 25 per day, notwithstanding the poor radio conditions. The messages handled through this one station alone, if sent by cable, would have undoubtedly cost the senders upwards of \$35,000. The text of a typical greeting message from 6BJX's message file may prove interesting and is reproduced with the consent of the recipient. "It is January first 1927 in the tropical Philippines and we bid sunny California a Very Happy New Year while it is still 1926 in the Golden State by means of short-wave radio which has done so much to reduce distances and make this a very small world. May this year's improvements be as phenomenal as last year's is my wish to the radio amateurs who are responsible for the present development. To you, mother and dad, we wish much health and happiness for the New Year." More power to you 6BJX! Keep up the good work. When there are messages for the Philippines we certainly know how we are going to route them.

2B0 and 6BSL recently hooked up for a trans-continental message handling bout. A message from New York was phoned to Los Angeles by 6BSL (Long Beach) and in just 21½ minutes the answer was back in New York. Just another little example of that thing we call "service" and all accomplished "via amateur radio."

6BVY's schedule with op1AU has now been in operation for about seven months. Many Philippine tourists have been kept in touch with their homes in the U.S.A. A college professor was located at the University of the Philippines. Late in August some very important traffic, possibly instrumental in the saving of a human life hanging in the balance was handled, giving authority to certain doctors in charge of an important case.

9CDE reports that traffic bound for Japan apparently gets through, as one message he QSRed through 6PR brought a letter in reply. JJOC is being heard in this country but no one reports hooking him yet. oa2CS offers his congratulations on message deliveries in this country in a message to the C.M. received through 9CLS. Ten messages he sent different stations for relay were delivered 100%. Perhaps the fact that his messages were all good meaning-full messages had something to do with it. We have observed that the important messages that really do mean something ALWAYS ARRIVE while it is the rubber stamp type of message that falls by the wayside. PLEASE MAKE THE TRAFFIC YOU ORIGINATE GOOD TRAFFIC.

OFFICIAL BROADCASTING STATIONS

Changes and Additions
(Local Standard Time)

Call	7.00 pm	10.30 pm	12.30 pm	Days of Transmission
1CMX	38	—	—	Mon., Wed., Fri.
2ADH***	—	—	—	Mon.
2APV	37.57	—	—	Thurs.
8APV	—	37.57	—	Tues., Thurs.
2BBX**	—	—	—	Mon., Thurs., Sat.
2CTH	—	20	—	Wed.
5ANC*	—	—	—	Mon., Tues., Fri., Sat.
9AUG	—	84	—	Tues.
9BKR	40	—	—	Thurs.
9BQO	40	—	—	—
9BQO	180	—	—	—

* 9 p.m., 80 meters.

** 6 p.m. Sat., 10 a.m. Sun., 37.56 meters.

*** 2.00 a.m., 80 m. Fri.

DIVISIONAL REPORTS

ATLANTIC DIVISION

EASTERN PENNA.—SCM, H. M. Walleze, 8BQ— We will not take much space on activities this month. They were not so hot and we have other business on the hook. 3HD says Phila. is a MESS. He is right. There are as many ORS in Phila. as in all the rest of the Section, but the average run of totals is a laugh. A half dozen real ORS in Williamsport not only handle more real traffic than ALL the rest of the Section but LEAD THE U.S. for number of msgs. per CITY. The rest must wake up and push traffic or fade out of the picture. A new policy is effective at once to be tried out in this Section. Each ORS must handle at least 10 messages per month. That is only a few hours work on ANY band from 40 up. Only a plausible, satisfactory and sufficient excuse will save your ORS if you fall down. Failure to see this notice is no excuse. But half of you read these reports, which is as bad as not reporting. If you have ARRL work at heart and are doing your bit by pushing GOOD traffic, this "talk" is superfluous. An ORS ticket in this section is going to be more than a DECORATION.

80 M. Stations: 30%—Handled 44%. Skeds kept a 8AVK busy. A power leak cut 8EU's total. 8AKW is rebuilding and is a PRR. 3NP slumped a little. 3SM is installing battery DC. 8WH says he will make the BPL next month. 8BFE is busy on PRR work. 8AFQ had the hard luck in the family. 8BCQ is active in W-B. 3HD razzed the 3rd Dist. work. 8AIY is having receiver trouble.

40 M. Stations: 20%—Handled 26%. 8VF is going to QSY to 80. FB. DX was punk for 8BLC. 8AIG hit the BPL again. 3BUV wasn't on much. 8AUV is now crystal controlled. 3BPL was very active. 8AVL is going strong. DX was FB for 3LW as usual. Low power steps across for 8BMS. 8RT was busy with other work. 8AY handles Army traffic. 8CCQ hit it up this time. 3ZM has the crystal control bug. 8CW flopped to 40. 3PY was not on much.

Both bands. 50%—Handled 80%. 8ADE says traffic was not so good. 8BIR lost tubes. 8ADQ and 8AWT had good totals. Things froze up for 3QL. 3BIT is buying big bottles. 3BP kept a few skeds. 8CGZ had a time with new inductances.

Please don't mail your reports a week before due. Get them in by the 26th, tho.

Traffic: 8ADQ 388, 8EU 850, 3AWT 233, 8CGZ 226, 8AVK 210, 8ADE 181, 8AIG 125, 8HLP 106, 8BFE 85, 8AUV 69, 8QL 55, 3SM 49, 8BQ 49, 8AKW 46, 8HMS 41, 8HD 42, 8CW 23, 8CCQ 82, 8AIY 18, 8WH 14, 8AVL 14, 8BCQ 13, 8RT 11, 3BLC 10, 3NP 10, 8BIT 10, 8AY 8, 8BQP 8, 3VF 6, 3PY 5, 8BIR 5, 3ZM 4, 3BUV 2, 3LW 2.

WESTERN PENNA.—SCM, G. L. Crossley, 8XE —The reporting for the month is very light for this time of the year. The reporting stations are also very lax in reporting regularly. About 20% of the stations report every month. Really, gang, I shall give a brass doorknob of excellence to all the stations in this section if for one month ALL THE ORS REPORT—AND REPORT ON TIME.

It is getting to the time of the year that the traffic and DX should be at its height. Some stations report a high originated total but fail to show very much in the relayed and delivered columns. Let us all try to get that traffic handled column up to a high mark after this month. The stations reporting to the SCM as being members of the PRR gang and doing REAL work are 8AGO, 8XE, 8BRM, 8VE, 8ARC, 8CEO, 8GI and 8BRC. This is a gang of traffic handlers the SCM is proud of, but where are the rest of the PRR gang? Why are they not ORS as well?

8ABW has changed his QRA to Johnstown and 8CES to Altoona. 8CEO is doing fine work on 80. 8AQG is still remodeling. 8GI is putting Xtal control on 80.5 meters. 8DHU has transmitter plug-in coils for B and C bands. He also has a code class at the Oakmont High which includes 4 YLs. 8AYH is putting in a new chemical rectifier. 8BRB is again on the B, C and D bands. 8DNO is having BCL trouble. 8CFR is now on with a 50 watter. 8CRK is on the A band with 7½ watt Heising fone. 8ZD

has been busy with the Xmas rush. 8BDJ is looking for traffic on the 80 band. 8VE is changing to a 400 watt self-rectified outfit. 8CKM will be on again soon with his 50-250 watt TP-TG xmitter. 8BBL says WX has been poor for DX but good for traffic. He handled 141 msgs. in one week of the Xmas vacation. Some of you who think there is no traffic should take notice that 80 meters has plenty of it. 8GK worked 23 stations in the month and found no traffic. This is on the 40 band. 8XE has been off regular schedule for the last week due to Xmas vacation. It is on 40 and 81 meters.

Traffic: 8XE 245, 8BBL 141, 8CW 130, 8GI 120, 8CEO 110, 8VE 103, 8AGO 94, 8BDJ 84, 8AQG 85, 8ARC 27, 8DFY 19, 8CFR 19, 8DHU 19, 8CRK 18, 8ZD 17, 8DNO 16, 8BRM 16, 8CYP 11, 8ABW 8, 8BBS 7, 8AXD 2.

DELAWARE—MARYLAND—DISTRICT OF COLUMBIA—SCM, A. B. Goodall, 3AB—Maryland: Chief activity centers around Baltimore. 3HG is probably leading the DX gang and may be heard consistently working the long range stuff. 3PH, another old timer, is in the 80 meter band with a 50 watter and arc rectifier. 3RF, 3CEV, 3PU, 3VI are all reported active. 3CJ, a new station in the town, is already active in relay work and promises to be a reliable contact point to the outside. 3VI and 3CGG both semi-old-timers, are heard occasionally. 3BUR and 3FS are in operation both on the 80 and 40 meter bands. 3CFX is often heard in the 80 meter band with a pretty DC note and seems to be handling an appreciable amount of traffic.

District of Columbia: 3BWT, as usual, is the leading traffic station. This is done chiefly by 80 meter schedules before 8 PM. After 10:30 PM, 40 and 80 meters are used for traffic and DX. 3CAB is still pounding away respectable traffic totals on both 40 and 80 meters. Both he and 3GP are in the unique position of being able to originate a large number of useful messages. 3ACM, after sickness, has his crystal transmitter on 39.3 meters.

Traffic: 3BWT 312, 3CAB 164, 3AB 143, 3NR 26, 3CJ 25, 3ACM 24.

WESTERN NEW YORK—SCM, C. S. Taylor, 8PJ —Western New York begins a new year with many old timers applying for ORS. 8AYB has been appointed Route Manager of W. N. Y., giving us one of the oldest operators in this end of the state to look after schedules, routes, etc. All interested in schedules and routes should get in touch with 8AYB at once. OBS are on the increase as well as ORS. The SCM wishes you all future success in the year.

8ADG reports 6 stations in Utica and 2 building and a 2nd op at 8ADG. 8AHC works South Africa, Iceland, Morocco and Argentina. 8AIL is still trying to improve his set. 8AKC is building a transmitter for the Mohawk Valley brasspounders, using B battery supply. 8ANX is still improving his set. 8ARG is working foreigners. 8AVJ works England. 8AVR is on 80 now and reports 8APK, 8ANX, 8BMJ all handling message traffic. 8AYB works all USA stations except 1, 2, 3 dists. Would like to know where gang are. His QRH is 77. 8BEN works China, receiving two Chink msgs. Wow, 8BGN works lots of DX also. 8BFC is handling traffic. 8BLL is at school. 8BMJ works 6th and 7th districts, Porto Rico and Mexico. He is an old timer—18 years in the game with spark, ICW and phone. Other O's will remember Maty. 8BQK handles traffic. 8BZU works lots of DX and reports 8DNH is on again. 8CCR now has a crystal-controlled set on 76.5. 8CDB is a new station handling traffic on 87. 8CNH is now handling traffic and attending school. 8CNT has schedules with 8AVB daily. 8CVJ is in line for ORS and has traffic. 8CTL has been heard in France. 8DDL has schedules with eg-2BOW on 80. 8DME has schedules with 8HJ, 8AHK and 8CVJ. 8DNE has schedules with 2AVB, 1BIG, 1BMG and 8AVX. 8DRJ states 2 new stations may develop in Amsterdam, N. Y. 8DSI heard in England on 5 watter and is after traffic again. 8HJ is handling Army, Navy and PRR traffic. 8KW is back again after 4 months absence. 8NT works DX and is now experimenting with antennas. 8QB reports PRR tests continue in fine shape. 8SD, 8DPL has been working 8YP, 8CGH and WSVS. 8VW is working Army-Amateur net stations mostly. 8CYB keeps schedules with 8BHM. 8BHM reports 8AST is on 42 meters and is a partner of his in the R. R. Phillips Laboratory.

Traffic: 8ADG 5, 8AHC 105, 8AIL 10, 8AKC 138, 8ANK 48, 8ARG 5, 8AVJ 19, 8CVR 24, 8AYB 18, 8BEN 18, 8BGN 17, 8BFC 4, 8BLP 2, 8BHM 49, 8BQT 29, 8BZU 4, 8CCR 68, 8CDB 21, 8CNH 8, 8CNT 23, 8CVJ 88, 8CTL 12, 8BEM 94, 8DDL 56, 8DME 36, 8DNE 322, 8DRJ 20, 8DSI 31, 8HJ 43, 8NT 18, 8QB 17, 8SD 4, 8VW 85.

SOUTHERN NEW JERSEY—SCM, H. W. Densha, 3EE—3BTQ has been kept off the air by overtime in his work but has come back strong with a new 203A. 3KJ reports 3FZ and 3PI are QSO most of the seashore resorts. The SCM would like to hear from these newcomers. 3ALX is now one of the ops at 8XE, 3SJ has added France, Portugal and 3 more Canadian Dists. to his DX record. 3BEI is sporting a new Marco short wave receiver. 3BWJ, who has been tied down with studies, reports that he will be on the job more consistently the rest of the season. 3UT had some tough luck and blew his 210.

The SCM asks the cooperation of all Southern New Jersey ORS in traffic reporting and doesn't want to have to cancel ORS appointments because the gang is careless about reporting.

Traffic: 3BTQ 4, 3UT 59, 3BEI 1, 3OQ 10, 3BWJ 2, 3SJ 24, 3KJ 1.

CENTRAL DIVISION

WISCONSIN—SCM, C. N. Crapo, 9VD—9DTK reports traffic flowing FB now. 9EK-XH keeps lots of schedules. 9BIB says Xmas greetings msgs helped total. Old Santa didn't even bring him a grid leak. 9AZN handled one Army message thru 9DTK to Chicago. 9BWO handled msgs on 20, 40 and 80. 9EAN was on only one week. 9EHM reports a 50-watt bottle now doing its best for the station with a good consistent range. 9AKY will be on the air more now as the weather is getting cold and the YLs do not require so much attention. 9COI's fifty wattter went to the happy hunting ground. 9SA was trying different types of rectifiers. 9AGV had to move his transmitter up one floor due to local conditions. 9ARE's transmitter is a 7½ wattter in a C. Hartley circuit, using grid mod. and phone altogther. 9BJY has put in a filter to stop BCL QRM, but it does not give D.C. 9EEM uses two fivers but has had some trouble in working out or he might have had a better msg. total. 9BPW is still using one CX-810 with about 20 watta input. 9DLD has two schedules going now and both only once a week. One is with 9CBE, Minneapolis, Minn., on 40 meters every Sun. at 1.00 p. m. and the other is with 9CFT at Schofield, Wis., on 80 meters at 3.00 p. m.

Traffic: 9DTK 528, 9EK-XH 476, 9BIB 119, 9AZN 66, 9BVG 31, 9EAN 25, 9EHM 29, 9AKY 23, 9EAR 17, 9COI 8, 9SA 3, 9CFT 15, 9AGV 2, 9BJY 10, 9EEM 4, 9BPW 18, 9DKA 56, 9DLD 46.

OHIO—SCM, H. C. Storck, 8BYN—8BVR, who has been out of the game for several years, takes high honors for Ohio this time. FB, OM, keep it up! 8BSY comes second. He is one of the hardest working ORS in Ohio. 8GZ comes third, which is quite a surprise, because he has been dormant for so long. He and 8BAU and 8BWW all have crystals and will be on the air with them soon. The SCM expects to follow suit when time is available. 8DO and 8CRP have been revived and have gone in together. 8AVB kicks in with a total of 105 and 8BAH with 103. FB, 8DJG, a non-ORS as yet, sends in his first report. 8AKO will be on consistently. 8AVX is a "comer" with lots of schedules. 8DBM is on 40 as well as 80 now. 8CWR comes thru with a good report and says he'd drop dead if he saw Dayton, Ohio, mentioned in QST. Dayton has been rather dead, but CWR is putting it on the map. 8CQU is a good schedule man. 8BPL turns in a nice total. 8PL has two crystals now and is on 37.67 and 39.35 meters. 8CTD is back after two years, and will be on regularly. 8BRU says traffic work requires schedules. 8SI keeps schedules with a 201-A. 8BNW will soon be an ORS. 8CFL is also a runner-up for ORS if he keeps up the good work. 8RJ is another modest ham on his reports, but a good consistent ORS. 8CMB is out after a flock of schedules. 8DIA says "Santy" brought a "Vibroplex." Watch for it on the air, fellows. We have a new ham here in Ohio, 8AKA, of Cambridge, ex8CGL, 9BJL and 9GX, a rover who has settled down in Cambridge and one whom the gang should help along for though he has not been on long, and has been working under very unfavorable conditions. He still turns in a nice total. 8CXW, another new one, at Middletown, is on for traffic and is going strong. 8AEU is making a remote control set.

8DDO has an ORS appointment. 8BKM's work keeps him from his set a great deal, but he QSRs FB when he is on. 8CBI says 40 not so good and he works 20 meters mostly. 8CPQ can't seem to make his 204 perk on 40 so he put it on 80 and has two 203A's on 40 and expects to turn in a good total next month. 8AYO is on the air regularly. 8DEM still QRW with school but does good work when he is on. 8DCF gets little chance to work also. 8IV, a newcomer in C. D. work, turns in his first report. FB, OM. 8APZ and 8DQZ are still experimenting with antennas. 8BKJ is on with crystal control and reports it FB. 8RY is back from 2EP and would like to hear from hams who can receive tests on 60 and 400 mc bands.

As a whole, the work this last month has been very good and the SCM is proud of the cooperation and good ARRL spirit of the Ohio ORS. By the time this gets into QST, all the dead-wood will be out, in Ohio, and we are going to start with a brand new organization for the new year. With the gang going as they are now, and with all the new blood coming into our little organization, WE WILL SURELY HAVE OHIO ON THE MAP IN JIG TIME OR KNOW THE REASON WHY! What say, gang? The SCM is working hard and the ORS are working harder than they ever did to help. Thanks, fellows, and keep up the good work.

Traffic: 8BVR 216, 8DSY 133, 8GZ 107, 8AVB 105, 8BAH 103, 8DJG 89, 8AKO 84, 8AVX 74, 8DBM 71, 8CWR 67, 8CQU 57, 8BPL 56, 8BYN 48, 8BWW 36, 8PL 23, 8CTD 28, 8BRU 22, 8SI 19, 8BNW 19, 8CFL 18, 8RJ 15, 8CMB 15, 8DIA 15, 8AKA 15, 8CXW 13, 8AEU 11, 8CBL 11, 8BKM 8, 8CBI 8, 8CPQ 7, 8AYO 6, 8DEM 6, 8CDF 5, 8IV 4, 8APZ 2, 8DOZ 1, 8BKQ 1, 8DGP 1, 8DDO 38, 8DIH 20.

KENTUCKY—SCM, D. A. Downard, 9ARU—9BWJ gets in the BPL this month. 9DTT lost his ORS. 9ALM is having plenty of time to work DX as he is quarantined for smallpox. 9ATV is re-building and hopes to have an ORS soon. 9ELL and 9WU are enroute on a trip around the world. Understand they have taken a short-wave receiver to listen for the boys back home. 9ABR was off the air for two weeks lamenting over the loss of a fifty wattter. He has another now and is making up for lost time. 9OX is on consistently altho married. Hi. He says he is getting to be real good holding "Jr." in one arm and pounding brass with the other. 9GC is a new old timer opening up at Bowling Green. Do you fellows know we have only eight ORS in Kentucky? Let's hear from you guys that are not one of the eight. 9ABR is R-M for Kentucky. ORS, please write him regarding your schedules, etc. We want some trunk lines in Kentucky that can be relied on. 9ARU wants schedules on 80 and 40 meters.

Traffic: 9BWJ 111, 9ATV 68, 9ALM 61, 9OX 51, 9ABR 16, 9ARU 12.

ILLINOIS—SCM, W. E. Schweitzer, 9AAW—For the information of our new stations opening up in Illinois, it is the desire of the SCM that you report regularly to him. It is not necessary to send copies of the messages you handle unless you are asked for them. The number of stations reporting during the year has steadily increased. Let's keep it up and see if it is not possible that every station in active operation has his report in on time. It is the desire of the SCM that each station reporting offers some constructive information along with his report to put in with the traffic reports. Let's not make your report a rubber stamp. With the opening of the New Year and the closing of last year's report now a back issue, may I wish you all a very happy New Year.

9AAE is operating 9NV most of the time. 9AGG's batteries went west with his tubes. 9AHJ is on 176 meters. 9ALK is asking for schedules. 9ALJ has been inactive this month. 9APY is keeping schedules with IAAP, 5ANL, 2CC, 3CEP. 9BIZ is experimenting with crystals. 9BKD is a new station coming on the air. 9BNA is on the 80-meter band at night and 40 in the daytime. 9BPX reports it hard to work west these days. 9BTK worked all U. S. districts, Canada and New Zealand. 9BWL using a sync rectifier supplies his 100 watts. 9CEC passed his radio exam OK. 9CEH is keeping many schedules. 9CEW just returned from WNX and bought the transmitter from WGDN for some 80-meter work. 9CIA works Australia and New Zealand regularly. 9CN works South America. 9CSB reports his Hertz works FB. 9CXC worked South

America, Europe and New Zealand and ships at sea. 9CYN is using 50 watts. 9DAF will be on the air on Feb. 1. 9DDC will be on the air with c.w. and phone on 175 meters soon. 9DGA reports 9DHF, 9BUH, 9BJL, 9AMA and 9WB opening up in Galesburg. 9DOX reports the quality of amateur traffic is improving. 9DQR is taking music lessons now so he is blowing on brass rather than pounding it. 9DXG is still working and going to school. 9DXZ is using crystal control. 9DYD reports plenty of QRM from BCL stations. 9DZR will soon have enough money saved to buy another fifty. 9EIA promises big traffic totals in the future. 9EHK is keeping many schedules. 9ELR is on 42.5 meters. 9GE is with us again. 9MR is away at school. 9NV keeps schedules with 9BFA and 9DTK. 9PU was home from school over the holidays. 9QD is on the PRR emergency route.

Traffic: 9APY 172, 9CSB 117, 9QD 105, 9BTX 100, 9CEH 97, 9UB 87, 9GE 68, 9BNA 68, 9CN 60, 9DYD 51, 9BWL 47, 9DOX 44, 9BL 43, 9CXK 41, 9NV 41, 9CPQ 32, 9CNB 31, 9CIA 29, 9BVP 27, 9ALK 26, 9RQ 26, 9BHM 25, 9EHK 23, 9PU 22, 9BPX 19, 9EAI 19, 9DGA 18, 9CSL 18, 9RK 18, 9DXZ 16, 9CZK 15, 9AAW 15, 9AJM 15, 9SK 12, 9CWC 11, 9ALJ 9, 9ELR 9, 9BIZ 7, 9AHJ 6, 9CYN 5, 9BKD 5, 9DXG 3, 9BBA 2, 9AAE 1, 9AGG 1.

INDIANA—SCM, D. J. Angus, 9CYQ—9CP reports that he has received the Narwhal tusk that Putnam gave him for working VOQ. Says that it is six feet three inches long, straight as a gun barrel and spiraled or twisted in its make-up. Congrats, OM, on winning it. 9BK worked a little in spite of the Christmas rush. 9DHJ is going again on 80 meters. 9BBJ succeeded in handling some traffic during his vacation during the holidays. 9DUZ is a very active station and can handle your traffic. 9FB has become a BCL. 9ASX is the most active station in South Bend. 9AMI is on whenever he gets home from Purdue. 9RUI is on 80 but QRMed by the YLs. 9AUX is having fair success on 20 meters. 9BQH using two 7 1/2 wattars, wants traffic. 9DDZ using an H tube, led Elkart for traffic. 9ABP uses tuned plate tuned grid and likes it OK. 9TL is going good on 80. 9CEM works for the fire department and the station there is not going yet. 9DHM has QRM from his radio store job. 9CJJ is a new ham going strong. 9BYI was waiting for kind-hearted Santa. Hope he was good. 9CEY is going good and trying for an ORS. 9AFA is using an H tube on 40. 9EF and 9DIJ are working on 20 and 40 meters. 9BSK is on 20 meters and works lots of DX. 9CP does his usual DX. 9AXO is having bad QRM troubles, can't even hear NKF. 9AIN now has a MG. 9ABW is on 40 now, 9AYO has a Mueller tube coming. 9DPJ has been in the east but his crystal-controlled station was operated by 9EKJ. 9BJR is going strong on 80. 9EGE says plenty of 40 meter traffic in day time but ND at night. 9CMJ has a new voltage feed Hertz up for 40 meter work and reports better DX than formerly. 9BCM is always on between 6 and 8 p.m. for traffic on 80 meters.

9CLO is busily engaged grinding crystals for the local sets. 9AXH says he is using 2 fifty wattars. 9ALH on with a single wire antenna and 40 meters. 9ACR cut out all local QRM by setting his motor generator on his inner tube. 9CBT is operating on 80 meters. 9CRV gets the best DC out of AC of anybody in town and with very little filter. 9DSC is splitting the air with his 40 meter set. 9APG uses a bug made out of safety razor blades, wire and nails. Sounds like a real one, tho.

Traffic: 9AIN 66, 9AYO 51, 9BJR 51, 9CNC 39, 9CMJ 32, 9BKJ 30, 9DPJ 15, 9DHJ 19, 9AEB 19, 9QR 4, 9ES 5, 9EJU 14, 9BGM 14, 9EGE 14, 9DDZ 41, 9CEY 36, 9BQH 32, 9BBJ 28, 9BYI 18, 9DHM 16, 9EF 16, 9ASX 14, 9DUZ 13, 9BSK 10, 9ABP 8, 9AUX 7, 9CP 7, 9CJJ 2, 9DIJ 2, 9BK 2, 9AXO 3, 9APG 7, 9CRV 35, 9DSC 15, 9CBT 25, 9ACR 26, 9ALH 5, 9ASJ 20, 9AXH 20, 9CLO 1, 9CYQ 33.

MICHIGAN—SCM, C. E. Darr, 8ZZ—9DCW is getting out well on very low power. ExxAPM was back for Xmas and says his station 7GW is doing fine work. Oa-2LO from Sydney was a recent visitor at 8ZZ's station. 8AUB is still pepping up the western Mich. bunch. He is some go-getter and hot after traffic. BCLs cut 8JG's antenna twice in a week. He has it on a roof now so they can't get QSO with it. HL 8AMS had bad luck with his antenna in storm and zero weather keeps it on earth. 9EAY reports heavy snow and ice and weather 13° below zero but radio goes along FB. 9CEP is getting along in fine shape after trying to knock

a M. C. R. R. freight engine off the track with his fiver. 8DED says schedules are the only thing for traffic. His report shows it. 8CCM says 700 volts of B batts will make his station talk from now on. 8CQG works Chicago schedules regularly and says they are FB. 8CWK has joined the BPL, owing to a new crystal-controlled set. 8ZZ has his crystal-controlled transmitter working on 41.7 meters. 8CEP is supplying local papers with ham news, which they print willingly. 8DIV is on regularly early evenings—a new antenna of cage type keeps him doing biz. 9EAY has lots of time for skeds—there's your chance to make one with him, fellows. 8BOK wants schedules. Michigan is making greater strides and we hope to do better as the old interest is being revived. C U at Michigan State ARRL Convention at Detroit!!

Traffic: 8BOK 16, 8CEP 130, 8ACU 10, 8DIV 5, 8DED 171, 8CWK 126, 8CQG 56, 8DAG 18, 8CCM 22, 8KN 18, 8DCW 1, 8SX 40, 8JG 1, 8AUB 108, 8ZZ 21, 9EAY 31, 9ANT 4, 9CE 12.

DAKOTA DIVISION

SOUTHERN MINNESOTA—SCM, C. F. Cottam, 9BYA—9GI—DCJ walks off with traffic honors this month by being on 12 hours a day and wanting schedules. 9CAJ, the R-M, sleeps very little and "ops" a lot. 9EFK was QSO of-8IX with a 203-A and got an R6 report. 9CBE, a new ORS, keeps 3 skeds. 9DBC, another new ORS, keeps 2 skeds while rebuilding. 9DGE leaves for Sioux Falls on work but will be at the key at 9DKL while there. 9AIR has been sick, copied long waves while in bed so is pretty speedy now. 9DEQ has had power QRN. 9GH is on 20 meters every Sunday. 9DMA is home from the "U" and using a UX-210. 9COS says he has to keep ice thawed off his insulators with a blow torch. 9BKX is rebuilt and the rectifier problem solved and with two ops, expect real results soon. 9BDW is rebuilding but with a fiver he was QSO of-8IX and Australia several times. 9CPM is still on with low power. 9BEZ reports a new ham. 9DHP fell off his chair and nearly wrecked his receiver when "HIK" in Haiti answered him. 9AXB with a 204-A and a mercury arc rectifier consistently works England, South Africa, New Zealand and Australia with no report less than R-5. 9DGM just installed a WE 250 wattar and a mercury arc. The gang is on 20 meters every Saturday and Sunday in this Section.

Traffic: 9GI-DCJ 204, 9CAJ 133, 9EFK 69, 9DBC 56, 9BYA 39, 9CBE 37, 9DBW 35, 9DZA 30, 9CPM 28, 9BEZ 12, 9BHB 9, 9DEP 8, 9DGE 7, 9AIR 4, 9DEQ 3, 9GH 3, 9DMA 2.

NORTHERN MINNESOTA—SCM, C. L. Barker, 9EGU—Activities in the Northern Section are progressing nicely. New certificates are being issued to all previous ORS that are in good standing, and new appointments are being made.

9EBC is back on the air again on the 80-meter band. 9BMX is still waiting for crystal. 9KV is very active. 9CKI is spending his Xmas money for a 50-wattar and reports the organization of a very promising radio club in Duluth. 9CPO is doing some 5-meter experimenting, and has just got going again after buying a new home. 9EHO is on 40 and 80 meters. 9EEP complains of irregularity in his work, hence some irregularity in his operating schedules. 9CWA keeps 4 regular schedules. 9BVH has another good crystal now and has done some fine work on crystal control with a very small antenna. 9DKR has changed to a single wire antenna and counterpoise and works much better. 9MF has installed a zeppelin antenna. 9CTW, in line for an ORS, is on 20, 40 and 80 meters. He gets some surprising results using an indoor antenna and counterpoise on the 20-meter band. 9BMR thinks he will have to overhaul his outfit. 9QT has three operators and keeps five regular schedules. 9EGU still has regular schedules and hopes to be on the air with crystal control soon. 9EIX has a new antenna 350 feet long and 110 feet high at the far end.

Traffic: 9EGU 96, 9CWA 72, 9BMR 31, 9DKR 28, 9MF 24, 9KV 24, 9EHO 23, 9CKI 18, 9EIX 17, 9CTW 15, 9ADF 10, 9EEP 8, 9CUM 6.

SOUTH DAKOTA—SCM, F. J. Beck, 9BDW—Activities throughout the state have been very gratifying, but we wish to urge more of the stations to work on 80 meters as that wave is very much the best to handle traffic on and it is possible to work local stations better than on any other wave. 9DWN hit the high mark as usual and is on the lookout for more

stations willing to make schedules. 9AGL's crystal transmitter is going fine and he reports 80 meters fine for traffic. 9ALN did some nice DX working PI easily and his usual traffic. 9NM is offering a prize to the high traffic man in the state for the months of Jan., Feb. and Mar. 9DGR made the BPL with raw a.c. on the plate. 9DIY is working at a broadcasting station but finds time to pound brass. 9DQV is a new station on in Sioux Falls. 9BBF at last reports he has the crystal transmitter perking FB. 9DBZ was forced to postpone the state convention due to lack of time but it will be held as soon as possible. 9TI is going FB with his fone set early in the evening and on c.w. on shorter waves later. 9BNV has applied for ORS and works on 41 meters. 9CZG is working on his rectifier. 9AZR reports good work but seems to be hard on tubes. 9BKB is getting a new tube for his set. 9DB-BDW has a nice break-in outfit.

9DWN, the R-M, reports that the state needs more stations on the 80-meter band.

Traffic: 9DWN 220, 9DGR 124, 9AGL 37, 9DB 23, 9ALN 21, 9TI 10, 9DIY 4.

NORTH DAKOTA—SCM, G. R. Moir, 9EFN—The SCM has sent his wife to the country and is ready to work DX all hours of the night. 9DYV is trying to get a Zeppelin aerial going. He is still on 40 meters. 9DM has no power yet. 9BVF blew his H tube but seems to get out just as good with a 201-A tube. 9DKQ informs us that he is an early AM pounder as QSO both coasts after midnight. 9CRB is busy in the electric business now. He reports a prospect coming up in Casselton under ex-9DXU, and one in Hunter.

Traffic: 9DKQ 19, 9BVF 50, 9EFN 39, 9CRB 3.

DELTA DIVISION

LOUISIANA—SCM, C. A. Freitag, 5UK—During the past month, 5ANC and 5AT were appointed ORS. 5ANC has also been appointed OBS. New licenses have been issued in Shreveport to 5KZ and 5KH. The Caddo Radio Club of that city expects to have its transmitter going very soon. 5EB, Oakdale, La., reports the following DX for the past month: Brazil, Chile, South Africa, Australia, Philippines and Java. He says ePKI reports his gra as Degroot Rongga Tjimahi, JAVA! 5UK now has two transmitters in operation; one in the 40-meter band and the other in the 80-meter band.

Traffic: 5ANC 85, 5EB 14, 5UK 30.

MISSISSIPPI—SCM, J. W. Gullett, 5AKP—Applications for ORS have been received from 5ANP, 5AUB and 5QQ. 5AGS has two H tubes which won't work together in a self-rectifying circuit so he is going to install a rectifier and use one H tube. 5FQ works the west coast consistently but doesn't seem to get hold of any messages. 5AKP wants messages going into New England States as he works the first and second districts every night regularly. He has a YL brass pounder at his station and also a YM who will take an active part in the operation of the old station before many years.

5AUB has a 50-watter on the air regularly at Tupelo. 5QQ is on 80 meters at night and 40 meters in the daytime. 5API has a schedule with 2DY nightly and is a good traffic-handler too. 5ANP is still representing the Gulf coast and is on regularly handling messages on the 80-meter band.

Traffic: 5AKP 72, 5ANP 38, 5API 26, 5QQ 18, 5AQU 12, 5AGS 2.

TENNESSEE—SCM, L. K. Rush, 4KM—What few ORS there are in Tennessee better get busy. There is still more room for ACTIVE STATIONS to become ORS. 4HL has been out of town and sent in a late report. 4CU has his transmitter in the house since he has been confined with a broken leg. 4FD reports traffic on 80 meters from 1MK and Canada is his best DX. 4FI and 4IX have been appointed ORS. 4EE is working a few with his 250 when not busy with school. 4FP is off the air and is at U. of Tenn. 4MM has dropped radio for the present due to sickness in the family. 4KM has solved the plate supply problem in the form of a 2000 volt, 1½ Kw. Escoc. 4KN is second operator at 4KM. 4BU has moved to a new location and going again with that 250. 4FL is heard quite often.

Traffic: 4FA 12, 4HL 11, 4FD 11, 4KM 6.

ARKANSAS—SCM, W. L. Clippard, Jr., 5AIP—Activities have been rather lax the past month but we have a bright outlook for the future. Lend a hand, OM, and let's put Arkansas on the map.

5AIF is busy converting BCL's. He suggests a hamfest. How about it. OMs? 5ABI moved from

Conway to Little Rock and is working FB. 5ABD, 5AQN and 5AIP are rebuilding. 5ZAA uses a 50 on 180 and wants schedules. 5HN is on 40 with a 50. 5ANB and 5AW report QRM from duck hunting. Hi! 5QH moved to Shreveport, La. and is now 5HF. Sorry to lose you, OM. 5PX contrived some new plug-in coils. FR., OM. 5ER has QRM from YLs. How about it OM? Hi!

Traffic: 5ABI 16, 5ZAA 6, 5HN 6, 5AIP 4.

HUDSON DIVISION

NEW YORK CITY & LONG ISLAND—SCM, F. H. Mardon, 2CWR—Things are starting to brighten up considerably around this part of the Division. Nearly all the old holders of ORS appointments have been given new ones. They have been told what is expected of them and what to expect if they didn't make the grade under the new SCM and this is no Hi Hi either. The Interborough traffic route is starting to take on the appearance of a real thing and although only a few stations have offered their services, the traffic is being carried on within the Section with wonderful results. More stations are needed in this work at once, and as soon as the 5 route managers get a schedule whipped into shape, full details will appear in this column. 2ANX is now RM for Manhattan, 2EV being forced to resign on account of work with the Edison Co. which is keeping him busy night and day. The SCM feels very proud of the gang this month and congratulates you all. Keep it up.

Brooklyn: 2WC is using two crystals and can QSY any of 4 waves in 30 seconds. 2CRB has finally become a WAC—nobody left to work but Mars now. 2IF is doing wonderful work with Army-Amateur net, handling oodles of traffic at 30 per. 2AVR is now an ORS and says he will work twice as hard as he used to. 2CTY is coming along fine. 2APD, another A-A station, is doing fine work. Our congratulations to 2BO on the arrival of a new OW who he says will be ready for the season of 1948. FB. 2CLA handled over 2000 words of press with 3AJL, 8CWK and 8ZZ. 2AUL has his set going on 40 and works fives and nines but gets no DX. 2WH is manager at WSA now so doesn't get on much.

Manhattan: 2ALS has just built a new low-loss 50 W. set that's a knockout. 2BNL says he's alive. 2BCB tells us that 2TC is still in Czechoslovakia logging U. S. hams. BCB is a new ORS. 2ANX is a live wire—get behind him, gang. 2KR is now using kenotrons for rect. getting out FB. 2CHK, portable 2DM, is getting out FB. He is going to Calif. so watch for him there. 2AFV has two new UX-210s to push traffic. He is trying to get Richmond going on the Interborough routes. 2AER is after schedules so get in touch with him. 2CEP is trying the 20-meter band but says he can't raise anyone but will keep trying. 2AKK is going good and helping to keep Richmond on the map.

Long Island: 2AWQ has a hard time hearing any DX in his location between three and midnight. He wants to know if anyone else around him is having the same trouble. 2ABF turned in his usual large report. 2AWX another live wire, sure keeps traffic moving. 2AYJ blew his 203 and can't seem to get his new WE 50 to work right but when he does, MARS stand by. 2AUE just put in a new 50 and a Hertz and expects to get going with a bang soon. Say, locals, answer 2KX when he calls. He has traffic for you and complains he can't raise you. We sincerely hope by this time that his wife, who was sick, is considerably better. 2AVB is trying to get L. I. lined up. 2AAS is doing fine—worked a 6 at 8.30 a.m. EST. 2BSL is also doing fine work. 2AJE is keeping things moving. He reports that 2AQs has moved to Calif. and is now 6BPM. 2AIZ manages to get on the air in the few days he was home from sea. 2GY is keeping experimental schedules with KGBB.

Bronx: 2BBX's aerial came down but he got it up again and after quite a job returning it, it gets out again the same as ever. 2CYX keeps things moving with 4 ops. 2AWU, a new station to report, certainly made a fine one. 2ALL and 2ALP have been very busy at school lately but manage to get quite a bunch thru each month. 2APV's mast came down but it's up again now and the familiar sigs will soon be going forward around the world as usual. Cancellations of ORS for failure to report and non-membership in the League are as follows: 2AOF, 2FK, 2KW, 2ADC, 2ABR, 2KU, 2UD, 2AEP. All other known ORS under the old regime

now have in their possession the new certificate. Any other certificates are now VOID.

Traffic: Manhattan: 2CHK 16, 2KR 23, 2EV 4, 2ANX 240, 2BCB 188, 2BNL 2, 2ALS 25. **Bronx:** 2APV 6, 2ALL 14, 2ALP 66, 2AWU 160, 2CYX 282, 2BBX 15. **Brooklyn:** 2BO 97, 2APD 57, 2CTY 3, 2AVR 121, 2PF 49, 2CRB 7, 2WC 72, 2CLA 116, 2AUL 6, 2WH 3. **Long Island:** 2AIZ 7, 2AJE 61, 2BSL 19, 2AAS 20, 2AVB 185, 2KK 7, 2AUE 7, 2AYJ 40, 2AWX 126, 2ABF 287, 2AWQ 27. **Richmond:** 2AKK 24, 2CEP 16, 2AKR 135, 2AFV 75.

EASTERN NEW YORK—SCM, Earle Peacock, 2ADH—Due to various reasons, the SCM has not been able to give the proper attention to the Section during the past month. What time was available for hamming was mostly spent on the air for a change with noticeable results. Hi. 2QU has been appointed 40 meter Route Mgr. 2ADH couldn't help making the BPL—they just snowed him under. 2AML seems to be pretty consistent, but YLs must be scarce in Chappaqua when he has to go to Ossining after 'em. 2ASE is the champ for making hand-painted report cards. 2LA is poking around on 40 for a change. 2CYM should get a rubber stamp marked QRW! He makes all the wheels go round in Spring Valley and is the fire dept. besides. 2PV and 2ANV seem to be having a rebuilding contest. 2PV is one receiver ahead, but 2ANV leads in antennas. 2UTH-2ACX had their 30 meter antenna break in half but they don't know whose half it was. 2AGQ was in N. Y. to the ARRL meeting and painted the town red. 2CNS's second op drew 4UO for a call when he went south to Georgia. The holidays knocked 2DD for a row of 'em. He still jams 75 meters whenever he gets a chance. 2AGM hasn't much to say for himself. 2UF was unable to put up his new 70 ft. poles due to sickness, according to 2ANV. 2AGP, 2AHJ and 2ABY are new ones. 2AHJ is ex-RDFI from the Atlantic Div. 8WU is also in Schenectady with a 2nd dist. station. The Yonkers gang has blossomed forth with a whole slew of new fifties. 2CUZ is back with us again and is knocking 'em cold on 40. 2CTF is getting out better than ever on 40. 2AAN is punching hole in the antipodes. 2CBG makes 'em step to keep up with him. 2AG is ruining good receivers on 80 with a wicked wallop. 2AUB is coming along. 2AAZ came home to pound the brass and found his tubes were NG. 2BOW is QRW building BCL sets to QRM with his new fifty. 2AAC is on again with a whole new station and seems to be the same old boiled owl.

Traffic: 2QU 140, 2ADH 125, 2AML 115, 2ASE 73, 2LA 17, 2CYM 16, 2PV 15, 2ANV 14, 2AAN 13, 2CTH 12, 2CTF 11, 2CNS 9, 2DD 7, 2AGM 5, 2AUB 4, 2CBG 3, 2AAC 35.

NORTHERN NEW JERSEY—SCM, A. G. Wester, Jr., 2WR—2CTQ reports 20 very FB. 2ADL accompanied with a short wave receiver has been visiting the hams of Washington. 2ANB handled a good number of Xmas messages. 2CW is using baking soda in his new chemical rectifier. 2FG with a Hertz worked Africa. 2BLM blew a fifty and now uses a five watt. 2DX too QRW for radio work. 2ADU off due to college exams. 2CQZ is installing a mercury arc rectifier for his 80-180 meter fone. 2QI is maintaining nightly schedules with 9ATQ and 9BJY. 2CP has been on the sick list but is now recuperating. 3AC from up state is the only amateur in Sussex County. He operates with fone on 80 and 180 meters. 2AVK is erecting a new mast for 80 meter work. 2IE is a new amateur in Jersey City which is pre-war 2AXG. Hasbrouck Heights is active with 2IS, 2AVL and 2AXP, who keep things humming. 2ARC reports traffic increasing. 2LAM has been off due to no A supply. 2CGK blew a 50 and now is using 10 watts. 2AT is the leading traffic handler in this district. 2KA after blowing tubes and condensers is back on the air. 2DY promises to be the best station in Jersey for 1927. 2WR very QRW installing a real transmitter which is to be remote controlled for 40 meters.

Traffic: 2CTQ 18, 2ADL 14, 2JC 2, 2ANB 23, 2CQZ 7, 2CW 20, 2BLM 12, 2DX 5, 2QI 15, 2CP 11, 2AC 10, 2AVK 1, 2IS 119, 2EY 3, 2ARC 34, 2ALM 36, 2CGK 3, 2AT 200, 2KA 7, 2DY 101.

MIDWEST DIVISION

IOWA—SCM, A. W. Kruse, 9BKV—Traffic totals took a BIG jump this month and all the ORS along with a bunch of newcomers reported on time. FBI The 80-meter stations still hold the lead in traffic handling, handling over 65% of the

traffic. 40-meter stations having 30% and the rest between the other two bands. 9CZC, the RM, is doing excellent work in lining up routes and schedules. Be sure and write him if interested in handling traffic on schedule.

9CZC is the star traffic man this month and says he beat the local RR agent. Looks like he beat the SCM, too. Hi. 9BKV has a bunch of schedules and promises to give the RM some competition next month. 9BWN had trouble with the BCLs but he made the BPL for the third consecutive time. FB. 9EJQ, a newcomer, hit the BPL for a goal, and gets fine reports on 20 using a zeppelin antenna. 9BAU reports a good total and says four-way break-in is the berries. 9AED has an awful wallop and led a fine bunch of traffic in addition to operating KMA. 9DEA is doing fine work and has 15 watts going on 80. 9DRA is going good on 40 and has changed from 7.5 to 15 watts. 9BFF was home on Xmas vacation and had the old set going full blast. 9CGY had office QRM and his traffic total suffered. 9DLR and 9EHN pound away on 40 and 80 and are new ORS. 9EGS was QRW installing Xmas radios so not much traffic. 9EFS handled a few on 20. (Why not try 30, OM?) 9CS has no plate supply for his 50 and says he has nothing else to feed it. 9DSL, 9AMG and 9BLH are still with us, but not much traffic. 9LC is the new Official Observer, so watch your QRH, fellows.

Traffic: 9CZC 314, 9BKV 284, 9BWN 181, 9EJQ 107, 9DAU 92, 9AED 76, 9DEA 75, 9DRA 35, 9BPF 32, 9DLR 31, 9CGY 30, 9EHN 17, 9EGS 15, 9EFS 11, 9CS 10, 9DSL 8, 9AMG 9, 9BLH 6.

NEBRASKA—SCM, C. B. Diehl, 9BYG—9DXY has heavier traffic than ever. 9AL is busy with Army work. 9EEW is working hard on his railroad. 9DFR reports QRM from YL. 9EHW is after traffic. 9BYG is still QRX. 9ASD works overtime on Army work. 9BOQ is hunting for work. 9DUO is busy at KOIL and 9DZT. 9CJT is rebuilding for higher power. 9DUH sings because there's not more traffic. 9BBS is rebuilding for better efficiency. 9AGD has found his pace and is making things "fly." 9BQR is very QRW in the Post Office at this time of year. 9EBL is going strong as usual.

Route Manager's report: Traffic is moving very nicely, not enough schedules to supply wants of the gang, every scheduled offered snapped up quick and everything working as fine as can be expected at this time on account of the holidays.

Observer's report: No violations reported this month in this Section and very few in adjoining



Sections. For this the SCM is very highly pleased and also very cheery. Hi!

9BKG and 9DI have applied for an ORS. We congratulate these boys as in doing this, they display their great knowledge and also their true ham spirit. 9BXT writes that it is impossible for him to retain his ORS appointment as he is very busy at school.

The SCM sent out a circular letter to all ORS stating change in his address, as he has purchased a new house and intends to be there for some time. The new QRA is 5605 Cedar St., Omaha. Quinby is sure hitting an awful pace and handling lots of

traffic, this a result of schedules, so take due notice and do likewise. Fetterman is working hard at his Army work and will make a name for himself yet. Cox says too much business on the road at this time of year and can't devote as much time to his "PR" as would like to. Henry has a lot of QRM in the way of YL. Crozier cusses because not more traffic comes his way. Williams is sure fanning the Army work and has many hours overtime chalked up. Magnuson wants schedules North and West. Shirck can't find time to work at home. Jones again says not enough traffic and schedules to keep him busy. Larimore has a new plate transformer and will knock things winding when he gets rebuilt. Stillinger handled 145 in 14 days. Chesley was tied up at the Post Office with Xmas mail. Slim again cusses the skip distances. He says he can't work closer than 500 miles. WJK of WOW is planning to be with us soon.

Traffic: 9DXY 374, 9AL 36, 9CJT 3, 9EEW 42, 9AWS 5, 9DFR 12, 9EHW 20, 9ASD 76, 9BOQ 21, 9DPS 5, 9DEC 10, 9DUH 25, 9AGD 145, 9EBL 169.

MISSOURI—SCM, L. B. Laisure, 9RR—9DOE led in traffic in St. Louis by one message. 9ZK-AAU handled the next highest score. 9DOE kept a sked every week day with 9EK. 9BWD is a new station. 9ZK boasts a new shack with all the comforts of home, including a bunk for visitors, and is keeping the foreigners busy writing QSL cards. 9DUD kept a Sunday sked with 8DED. The ORP met at his place but could not do much thru QRM from 9AOT and 9ZK. 9DLB was not on much this month on account of building a sink. 8BHI was out of town last month and missed reporting, but reports this time that he is handling a fair total and working some DX.

9DVF was going to make this a banner month in traffic but did not calculate on being sick. 9BSH reports not much station activity but several meetings of the gang were held. 9BWR operated at school by 9AJW and 9UI was not on as much as usual account of school QRM and a blown 50. 9CXU sent his November report too late to get in with state report and is now QRT as antenna fell down in last storm. 9ARA reports several msgs. and a long string of DX. 9ARA is quitting ham radio for school and the set is for sale. A new station is in prospect in Marceline, Mo., operated by N. E. DeYoung of that place, call not known yet. 9DAE finally got going with a 210.

9BSE kept sched with 9DSR. 9BUE worked on high waves and kept sked with 5ES and 9COP. 9AYK kept several skeds, but is quitting ham radio for



school. 9CRM got disgusted with the set when it would not radiate. 9DAE succeeds 9AYK as an OBS. 9CDF is still QRT going to Western Union school. 9AEO requests inactive status for 3 months on account of school. 9DKG kept skeds 5 times a week with 5ANP but school QRM bad. 9BOE is a new ham in Columbia. 9DIX handled a few msgs. and reports 9EBV failed to come home for Xmas from 9EK, and 5GG, who was 2nd op at 9DIX, had to leave for home, consequently DX had to do all the brasspounding alone. 9DMT reports a fair month in traffic. 9CBC is a new station using B battery supply on 180 meters.

9ACX went back to 80 meters for some traffic handling. 9ADR is still on 40 and 20. 9ACA built

a new receiver that looks like a Swedish cash register but works. 9DAQ is on at times. 9BSB is building a new set. 9RR kept scheds with 9DXY when conditions permitted. 9ZD is off mostly but has a low power set on 40 and 20. 9KM got a new call for his station on the Missouri side of the state line and drew 9LM. 9BKK and 9BJC returned for a few days at home away from commercial operating. BKK took parts for a ham set back with him and will be heard soon.

Traffic: 9DOE 134, 9ZK 183, 9DUD 52, 9DLB 2, 9BHI 42, 9DVF 11, 9BWR 10, 9CXU 13, 9ARA 13, 9DMT 31, 9DIX 15, 9DAE 108, 9DKG 28, 9BOE 10, 9AYK 4, 9BUE 11, 9BSE 5, 9ACX 15, 9RR 107.

KANSAS—SCM, F. S. McKeever, 9DNG—The new R-M, 9BGX, is doing his best to organize the Kansas stations; let's all help him, gang, and things will go over with a bang. The 250 watter at 9CET is still doing its stuff; his official broadcasts are heard regularly everywhere. 9AEK is QRW school and

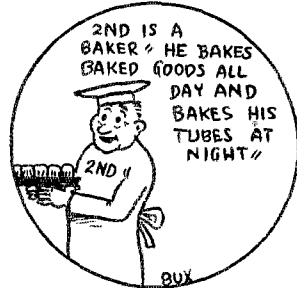

work so is not on so much. 9CV has his mercury arc rectifier working fine. 9BHR is settled in a new location and reports 20 meters as good as 40. 9DET is a newcomer in Lawrence who shows promises for the future. 9LNL and 9CLR were reported in England; the former works Africa and Australia, the latter blew his 50 watter after being QSO Italy and Brazil. 9COR is bothered by bad QRM but is on some. 9BYQ keeps a bunch of skeds and turned in a fine total. 9DNG is very QRW but worked some DX and handled a bunch of Xmas messages. He and 9CET spend their idle time trying to make their sync work. 9CKV finds the 80 meter band best for traffic. 9AVM makes use of all the bands with good results. 9DFK is on regularly and is doing good work.

Traffic: 9DNG 78, 9CET 31, 9AEK 3, 9LNL 19, 9CV 14, 9BHR 4, 9COR 4, 9CLR 3, 9CKV 42, 9BYQ 22, 9AVM 4.

NEW ENGLAND DIVISION

RHODE ISLAND—SCM, D. B. Fancher, 1BVB—Providence: 1CKB recently phoned a message to a party that originated in Brazil. It took the message one day to reach its destination. That's what we call good delivery. 1MO is a new station that will soon be an ORS and has been getting things ready for a big season. 1AMU is a new ORS and has been doing good DX. 1AWE is still QSO the world. 1AID says that Santa surprised her with a new charger and a pair of Baldwin phones. She has been on the sick list for the past two weeks but is at it again. Things are about the same with 1AEI. 1EI is another new ORS.

Westerly: 1AAP broke his last month's record this time. Cliff worked overtime to land that Trophy but ND. Think he deserves special mention, tho. 1BVB went over last month's report, also. It was due to the holidays and a lot of traffic was originated from local parties sending Christmas greetings. 1BLW is on the sick list and probably will be for some time to come. 1ANX is preparing to open up again after a long absence. He has acquired a new OW and we have a faint suspicion that was the reason for the absence.

Newport: 1BQD is still the only active station here and is getting out well. Unavoidable circumstances kept him off the air part of the month so not as much traffic was moved as was expected.

Traffic: 1AAP 1018, 1BVB 398, 1BLW 310, 1AID 187, 1BQD 35, 1AWE 17, 1AMU 14, 1AEI 7, 1EI 7, 1CKB 6.

EASTERN MASS.—SCM. R. S. Briggs, 1BVL—Quite a few non-ORS made the BPL. Fine work, fellows! Some of you have already applied for certificates and certainly deserve them. IYS leads this month, reaching the 300 mark. 1BMS plans to take things easy but his report didn't show it. 1AYX had schedules with 1AID, 1BMG, 1AAP and 1RO. 1BCN tried a vertical antenna but returned to horizontal one. BCL Xmas sets have been keeping 1AVY on the go. 1ADL has been very active. He has had fine results using a Zeppelin antenna. 1DL, 1PB, 1ADL, 1APK, 1BYV, IYS and 1GP have applied for ORS appointments. 1ABA is stepping out on 20 and 40 meters. 1JL says traffic and DX are fair on 80 meters. 1KY is motoring to Philadelphia. 1NK reports his famous UX-210 dead at last but has a new tube and handled a pile of traffic. We are sorry to learn that 1CIT is quitting the ORS game as he is QRW at college. 1NV is on 20 meters and is QSO Europe on 40 meters. 1BKV has been improving his set. 1XM has been active handling traffic, working DX and broadcasting Standard Frequency schedules. 1CJR, 9BNO, 1AUV, 1PP, 1KV, 8CHM, 1ASL, 1QX and 1BVL are some of the ops there. 1BVL is trying to make the "Wackers" club, using a lonely 5 watt. 1GA and 1AXA are still knocking 'em dead with their Xtal control sets. Apparently, 1AGS's 199 is still doing its stuff because he worked the west coast with it. 1UE says he feels like taking a radio vacation. 1CJR handled some traffic during a vacation. 1SL is installing a Xtal transmitter. 1ADM says he hooked up with ef-ACD and ef-8CT on 20 meters. 1ON is having trouble with power transformers. 1AWB is busy pounding brass at IYS and 1AWB. 1LM reports everything OK in Lowell. Things have been lively for 1BYV, who, by the way says he lives in the styx, for his antenna came down and his 110-volt mains were all wet.

Traffic: 1YS 301, 1UE 270, 1NK 266, 1BMS 235, 1JL 168, 1LM 167, 1ADL 156, 1BYV 133, 1BKV 130, 1KY 126, 1DI 119, 1XM 117, 1AYX 81, 1GP 76, 1ACA 53, 1GA 41, 1AWB 40, 1APK 36, 1BVL 33, 1BCN 31, 1AGS 30, 1SL 29, 1ABA 21, 1ON 19, 1NV 14, 1CJR 10, 1ADM 9, 1AVY 7, 1OU 6, 1PB 5, 1AXA 5, 1ALP 1.

MAINE—SCM. Fred Best, 1BIG—Maine has eight members in the BPL this time: 1BFZ, 1AIT, 1EB, 1ATV, 1HB, 1AQL, 1FP and 1BIG. 1BFZ is still bothered by a troublesome power leak, but he knows how to overcome such difficulties, as his total proves. 1AIT's pet tube went west but he carried on successfully with a UV-201-A. 1EB has been trying for an ORS and look at his qualifying total. 1ATV had plenty of Christmas messages QRM but carried on just the same. 1HB uses a bug to advantage in his traffic work. 1AQL lived up to his promise and has joined us in the BPL. 1FP did the same steady consistent work and landed up with the leaders once more. 1BIG was laid up twice during the month with OM sciatica and lost his pet schedule with 1BMS. 1ADI got going on Thanksgiving day and hopes to become a BPL member before many moons. 1COM handled quite a lot of traffic during vacation and turned in his usual fine report. 1QY is now all settled in Auburn at a new location and bids fair to burn up the ether during the remainder of the winter. 1CFO turned in a fine report of activities in So. Portland. 1BNL is now located at Biddeford and has more time for radio than formerly. 1KL has been experimenting with crystal control. 1AYJ has had tough luck with his UX-210 tubes and by now, should have an H-tube perking on both 40 and 80 meters. 1ABV has started up and plans on handling a little traffic now and then.

Traffic: 1BIG 434, 1BFZ 323, 1AIT 238, 1EB 223, 1ATV 202, 1HB 176, 1AQL 141, 1FP 104, 1ADI 23, 1COM 22, 1AYJ 13, 1QY 13, 1BNL 10, 1CFO 8.

NEW HAMPSHIRE—SCM. V. W. Hodge, 1ATJ—The R-M, 1OC, is high man this month. He has schedules with nine stations. 1AOQ has finally found a circuit that will work and turned in a fine report. 1IP, a new ORS, handled the first Army msg. to this city. The BCL business is keeping 1AER from being on more. 1AVL says he is going to make the WAC or bust. Hi. 1CKK pounded out a few on his crystal while home from college. Dr. White, our Director and 1BMK-1XP, is on 20, 40 and 80 and reports working en-OPL. 1AIP and 1ANS are new comers and sent in fine reports. The gang handled a total of 2220 msgs this month

which is very FB. About half of the stations are on 40 and report traffic picking up. Please send in more news with your report. Get QSO 1OC-1BFT for schedules.

Traffic: 1OC 780, 1ATJ 649, 1AOQ 222, 1AVL 150, 1IP 107, 1AER 94, 1ANS 83, 1AIP 76, 1XP 22, 1JN 20, 1CKK 7.

WESTERN MASSACHUSETTS—SCM. A. H. Carr, 1DB—1AAC has got his new 50 and equipment from Santa Claus so watch the smoke from Chicopee Falls. 1AAL, our RM, has worked out a fine net for Western Mass. and traffic ought to move lively with lots of it. 1AJM gets a score of 230 messages and clinches BPL again and top of Western Mass. 1AMS has a new KFUH transmitter. 1AMZ was on again for Christmas vacation and handled almost enough messages to make the BPL. 1AOF, an OBS, is on phone on 85 meters with 500 watts, each Thurs. night at 7:00 p.m. 1BOM, who has been on the sick list for nearly 2 months, was QSO Aussie with 291-A and 500 volts B batteries. 1BNW is going on the air soon with a crystal control. 1ARE has started off again and is keeping some schedules. 1ASU says he will transmit on 20 meters Sundays starting Jan. 2. 1AWW has his new mast up and is perking out fine. 1BAL is off temporarily. 1BVR worked 6ER at Sacramento, Calif. when he came home for his vacation and is all pepped up over it. 1BSJ is rebuilding his station and will not be on the air for three months. 1PY has been QSO Brazil and Australia. 1VC is on 20 meters all day Sundays. 1XZ is on the air but not handling much traffic. 1UM has been QSO Italy. 1VZ has had a schedule with England. 1LC is using a new "sink" rectifier. 1AZD is sure doing FB for our new ORS. He worked 9ZE on board the S.S. West Chairwood.

Traffic: 1AAC 6, 1AAL 106, 1AJK 25, 1AJM 230, 1AMS 1, 1AMZ 86, 1AOF 14, 1ARE 16, 1ASU 30, 1AWW 26, 1AZW 22, 1EO 13, 1DB 41, 1PY 2, 1VC 11, 1UM 10, 1AZD 47.



"RED HOT MAMMA"

VERMONT—SCM. C. T. Kerr, 1AJG—The SCM is now on the air on 38 meters. 1IT and 1TJ are on the air and sure pounding the traffic. 1BJP moved but is going again. 1YD gets the star this month for handling the most messages. Keep it up! 1FN and 1ATZ are passing them along in fine shape. 1EBE is second high man in traffic totals. 1BBJ says that his 5 watt wouldn't take 1,000 volts. 1AC lost his YL so will be on soon. 1BQ has been operating at 1YD. He turned the message report in.

Traffic: 1AJG 10, 1BBJ 1, 1EBE 29, 1FN 2, 1YD 79.

Connecticut—SCM. H. E. Nichols, 1BM—Our report this month very decidedly shows that consistent schedules and real honest endeavor has given us the banner total. This is the highest we have ever reached and it is due to the spirited interest that has been shown that we have been able to accomplish it. The SCM extends heartiest of thanks to all with the best of wishes for continued success in the coming year.

1BMG and 1MK, two of our newest ORS, have set the record for us to try and maintain. Schedule operating was their secret and deserves imitation. 1BHM, R-M, reports that his section is fairly active and that he hopes to get his stations working schedules more regularly. 1MY says that 20 meters is great stuff. He is working the Coast at noon and is QSO Australia quite regularly. 1BEZ has

been reaching out to Africa and Australia and says he would rather have traffic if he could find it. 1CJX has been doing some very notable traffic-handling with a fiver. 1AOX reports the sad news that his fifty has gone west. He was appointed an OBS and will soon be sending out the broadcasts. 1AOS reports his delight at working the old home set during his short vacation for the Holidays. Sure glad to hear from you, OM. 1VY has been struggling to get his crystal control set going and has been the victim of much joking, but he says he is smiling now when the fellows like his beautiful flute-like note. 1BOA, 1BMG and 1KP are recently appointed ORS and we welcome them to our ranks.

Traffic: 1BEZ 8, 1BHM 129, 1AOX 142, 1BQH 5, 1BJK 10, 1MK 313, 1CTI 17, 1BMG 848, 1AOS 19, 1BOA 6, 1CJX 58, 1ACO 7, 1BLF 21, 1MY 9, 1TD 1, 1FD 2, 1BGC 6, 1ADW 19, 1AVX 2, 1HJ 6.

NORTHWESTERN DIVISION

ALASKA—SCM, L. H. Machin, 7FD—Alex Sokolof (7KK) Box 795, Juneau, Alaska, is on the air anxious to work on schedule with Pacific Coast stations at 9 p.m. P.S.T., the wave length to be lower than 80 meters—traffic for each schedule guaranteed! 7BB, 7AM and 7IF are reported as excellent steady sizers from the States.

MONTANA—SCM, A. R. Willson, 7NT—7AAT is putting his town on the map. 7PU keeps up his usual good work and went over the hundred mark this month. He keeps six schedules. 7DD put thru 79 msgs in spite of unfavorable conditions. It's hard for anyone out of Butte to realize the tough time he has. 7AAW is climbing right up and will get his ORS this month. 7FL handled some traffic from College at Bozeman. 7ZU is back on the air after quite a silence. His college advanced work



and teaching haven't left much time for DX, but he handled some traffic anyway.

7NT is back home for a while and is now remodeling both his xmitter and receiver for the first time since the fall of 1923.

Traffic: 7AAT 111, 7PU 108, 7DD 79, 7AAW 16, 7FL 8, 7ZU 7.

IDAHO—SCM, H. H. Fletcher, 7ST—Going up! 7JF leads the state again. He kept 11 schedules. 7JF, 7YA and 7ABB made the BPL. 7QC is kept busy at work. 7GW is on 80, but can work on 40. 7PJ is on regularly. 7PS is busy selling BCL sets. 7ZN is not on a great deal. 7QA moved to Nampa and will work on 40 meters. 7ACN and 7ACK are new hams in Nampa. 7FB and 7QP are in Lewiston. 7CW, 7NW and 7ACR are new Boise fellows. 7CW is on with a fiver. 7UD sailed for the Orient. 7ABB is a new ORS. 7GX and 7EU are coming on the air soon. Miss 7SI announces her engagement to 6AIC. Congratulations.

Traffic: 7JF 405, 7YA 222, 7ABB 155, 7QC 59, 7GW 29, 7ST 16, 7ZN 7, 7PJ 8.

PACIFIC DIVISION

SANTA CLARA VALLEY—SCM, F. J. Quement, 6NX—With 6AMM, 6BVY, 6AZS, 6CKV and 6BYH making the BPL this month, this Section had the mots successful month in its existence. 1324 messages were handled by 15 stations. 6AMM was the main contact station for the coast. 6BVY maintained his usual schedules with PL. 6AZS, a new ORS, started up with a bang which landed him in the BPL. 6CKV struggled thru heavy QRN (power leaks) to make the BPL. 6BYH, another new ORS, made the BPL. All these stations had schedules, without which this good work could not have been done. 6CLP just missed the BPL, but

will make it next month, according to present indications. 6CSX, new president of SCCARA, handled his usual amount as did 6BMW, who is now using a pair of 50 watters as kenotrons to run his 250. 6DDN, with 32 watters input, started his first month as ORS by handling many messages and maintaining schedules. 6BTJ, 6BNH and 6CEI handled their usual amount of traffic and are on the air consistently. 6ACQ organized Radio Club now has 50 members, code classes. FB—SCM. 6CJD still QRW school work. 6CUL put in a 50 watter. 6BEU is new station that will soon be ORS. 6KG introduced a new super-het for the short waves and the following are now using them as regular receivers: 6KG, 6NX, 6ARV, 6CDF, 6BMW—Ask 6KG for dope.

Traffic: 6AMM 560, 6BVY 135, 6AZS 134, 6CKV 138, 6BYH 108, 6CLP 71, 6CSX 48, 6BMW 34, 6DDN 25, 6BTJ 21, 6ACQ 16, 6BNH 14, 6BON 12, 6CEI 9, 6BEU 4.

EAST BAY SECTION—SCM, P. W. Dann, 6ZW—Well, fellows, by the time this report is printed, we will have started on another year, and the SCM for the East Bay Section will be in office. Please get behind him, gang, and help him put the Section at the top.

Chief R-M. J. H. MacLafferty, Jr., 2901 Rawson St., Oakland, has charge of the East Bay Section (see Dec. 1926 QST for the counties which it includes). He has appointed 6CCT as R-M for Oakland. 6RJ uses two 201A tubes and 300 volts on the plate. 6CTG reports bad luck with an H tube, but is getting out fairly well now. 6BBJ has broken ground for a new station and keeps schedules with 7EO-7IF-9DTX and 9DKQ. 6CMG has worked all countries, so he says. 6CLZ, 6BER QRW with school examinations but will be back about the first handling traffic. Take a look at 6RJ's total this month. FB. OM.

Reports must be in my hands, fellows, by the 26th or 27th and no later. Reports received after that date will go in the following reports.

Traffic: 6RJ 155, 6CMG 10, 6BBJ 9, 6BER 4, 6CTG 4.

NEVADA—SCM, C. B. Newcombe, 6UO—Hats off to 6ABM, the new R-M. He has schedule with 1MK Tuesday and Thursday at 11 p.m. PST. 6GA has gone to St. Louis and reports at the altar for wedding vows. 6CRV made lots of noise until his generator burned out. 6UO spent Xmas assembling 2QA's smitter. 6CDZ is doing good work and is in line for ORS.

Traffic: 6ABM 154, 6UO 13.

HAWAII—6AXW with 500 cycle batted his way into the BPL and then some. 6CFN managed to put out a few between circuits. 6BDL did fairly well with his new supply.—DC? 6CFQ with electrolytic is stepping out better than ever. 6CLJ did some traffic work when not QSO foreigners. 6KQ and his pair of 7½ watters did his bit. 6DCU shoved a few along during spare time.

Traffic: 6AXW 217, 6CFN 61, 6BDL 36, 6CFQ 30, 6CLJ 17, 6KQ 9, 6DCU 5.

PHILIPPINES—SCM, M. I. Felizardo, op-1AU—The SCM keeps regular schedules with 6BVY and 6BHR Mon., Wed. and Fri. 5.30-6.30 a.m. PST. At this writing, the Section Manager has just taken office so there is no regular section report for QST. All active amateur stations in the Philippines are requested to report to the SCM, whose address may be found on page 3 of each QST. Please get behind your own duly-elected Section Manager to put our Section on the map.

Traffic: 71.

ARIZONA—SCM, D. B. Lamb, 6ANO—6BWS and 6BJF have installed rectifiers of 24 jars. 6DCQ has a fifty going now and has put it in oil and is kicking out FB. 6CDU is a new fellow with a 201A, 200 volts B. battery and everyone thinks he is c-c. 6ASA is at school, so finds little time to pound brass. 6ANO is on regularly now with two new ops. 6BJI was having trouble in finding his wave. He thought he was on 40, but found that his wave was 18 meters and wondered why he couldn't raise anyone on 40. Hi. 6AZM, at Miami, uses a 7½ watter. 6CAP has a UX210 on the 40 meter band. 6CUW is fooling around with receivers. 6YB has a rectifier now that gives a pure DC tone. 6CBJ bought a 250, but soon sold it for more than he gave for it. Hi. 6AZV and 6AZU are both coming on soon. They have a radio shop in Tucson and have to please the BCLs as well as the hams. Hi.

Traffic: 6BWS 84, 6CAP 6, 6YB 10, 6ANO 303, 6CBJ 7, 6CDU 14, 6CUW 10.

LOS ANGELES SECTION—SCM, L. E. Smith, 6BUR—Well, fellows, I told you that I was resigning last month, but Handy still has me on the job. I shall hang on until you elect a new man who can give you more time than I. Santa Claus made us a present of a big traffic total with ten stations in the BPL. Thanks, fellows, for the Xmas greetings.

San Diego: 6AJM leads with over 200 messages. He will be on with a crystal control soon. 6BQ is second in traffic with 150 messages and is San Diego's Official Observer. Ask him for a wave check, OMs. 6BAS has a super het receiver and a crystal transmitter. 6CGC, the RM, has been doing fine work, holding meetings of the ORS, arranging schedules, etc. 6DAU is on regularly with a 50 watter.

Los Angeles: 8 stations in the BPL. Fine work, fellows! Keep it up. 6ZBJ leads with over 300 messages. He does it with schedules and says that keeping his wave the same every night helps a lot. 6BJX comes second with 296 handled. 6BHI is third this month. 15 active days put 6CYH in the BPL. 6ALZ, a new ORS, made the BPL with a 5 watter. FB. 6CCO of Rivera, also got into the favored class. 6BXD of Pasadena, is a consistent BPL station. 6BBV has sold out to 6CYU and bids us farewell, but remember, once a ham, always a ham. 6CMQ is on 80 now with a VT2. 6VO hooked with fo-1SR, daylight on this end. Commercial radio keeps 6BGC on the go. 6AJI says he is about to pass the fourth stage of a ham's life. Adios, OM, and good luck! 6BUX does good DX but little traffic. 6RF says it's not YLs after all. Radio is his 1st love. 6OR keeps a sched with 4TK. 6CTP is working with a B. battery plate supply. 6BYZ uses two 7½ watters and works everything. 6ANN says his shack is so cold, it will freeze ice cream without a freezer. 6CMY is going in with a crystal 50 watter. 6AOY is busy with KWTC. 6CLK handles good traffic, but is getting a little interested in YLs. Careful! 6AHP is working out on 20 meters. 6DDO, the Los Angeles RM, has worked everything but Europe and working hard. 6AKW is back on the air again. 6AM traveled most of the month. His portables are 6MA and 7MB. 6DAQ was on but one week. He is changing to 20 meters. Our recent windstorm took down both of 6BHR's poles. 6CQA is very busy with his YL, but does fine DX and good traffic. 78 messages is all 6CSW says for himself. Enuff! 6CT helped swell the Whittier traffic total. 6ASV will be on soon. 6DAL, 6DAJ, 6AKX and 6CNK are all pretty busy but keep on the air part of the time. 6NW keeps a sched with xc55 in Mexico.

Fresno: Traffic has taken a big rise here and the BPL will soon be reached at the present rate. Fine work. 6BVN works schedule with 6ANO and has several others. His traffic total shows it. 6CCL also handled good traffic and is looking for more schedules.

Traffic: 6AKX 17, 6DAI 20, 6CT 40, 6CSW 78, 6CQA 39, 6DAJ 1, 6NW 16, 6BVN 72, 6CCL 45, 6AKW 2, 6AM 2, 6DAQ 40, 6BHR 15, 6AOY 10, 6CLK 57, 6AHP 42, 6DDO 41, 6BYZ 46, 6ANN 70, 6CMY 70, 6BUX 6, 6RF 10, 6OR 21, 6CTP 12, 6BBV 2, 6BVO 18, 6BGC 26, 6CMQ 5, 6BAS 3, 6CGC 24, 6DAU 23, 6ZBJ 331, 6BJX 316, 6BHI 230, 6AJM 209, 6CYH 116, 6BQ 148, 6PV 147, 6ALZ 135, 6BXD 116, 6CCO 110.

SAN FRANCISCO—SCM, G. W. Lewis, 6EX—6RW is the star station again for this month. 6CIS, lately moved from Yosemite, is a live ORS and on the job consistently. 6EX and 6VR have received permission to operate a fone on the 40 meter band and have done some good DX. 6VR working sc-2AS and 6EX working nj-2PJ on voice. 6AWT promises to come back on the air soon. 6AON blew the works and is off radio for good. 6SZ will be on by this time with the big 1KW transmitter. 6HJ and 6GG are appearing traffic with an auxiliary set on 80 meters. 6AWA, 6BIA, 6CCR and 6GW are on almost every night hunting for traffic. Between 6 and 8 p.m. PST, traffic for San Fran. goes through 6VR, 6KW, 6EX and 6GW. During the quiet hours, 6GG, 6PW and 6KW are on the job. After 10.30, 6HJ, 6CIS, 6CLS, 6CHE and 6PW take traffic. 6HJ being a boiled owl, is on till 5 a.m. when 6RW gets up to handle his rock crusher. After 9 a.m. 6HH and 6DAW, the two High School sets, do their stuff. You can QSO San Fran. any hour of the day.

In Santa Rose, 6ADM, 6AAT and 6BYS are the only active stations while 6BAF in Eureka exists by himself.

Traffic: 6RW 109, 6PW 51, 6KW 50, 6VR 51, 6AXC 3, 6CIS 51, 6CCR 30, 6BAF 5, 6EX 16, 6HJ 54, 6GW 17.

ROANOKE DIVISION

VIRGINIA—SCM, J. F. Wohlford, 3CA—There are a lot of ORS that rate cancellation if the reports do not get in in better shape. There is absolutely no excuse for not reporting as the cards are sent you with the bulletins from Hartford; they bear stamps and all that is required is to simply write half a dozen words or so and then you are safe. Unless the reports are received, we can make no showing, regardless of how hard some of us work and how much time we spend on the game for your good.

3KU has schedules with 4AAM and handles considerable traffic. 3JT and 3II will be on shortly—waiting for licenses now. 3BGS was too busy with the old job to do any work or handle any traffic, but he sends in a report regardless of other duties. 3KG operates the old set some, while 3BGS is at work. 3BZ comes out with an 80-meter transmitter. 3CKL is working on his crystal set and expects to be on the air right away. 3BDZ and 3CA expect to get on with crystal sets soon.

Traffic: 3KU 77.

WEST VIRGINIA—SCM, C. S. Hoffman, Jr., 8BSU—8WK is the Telegraphic Radio Club of Huntington. 8AMD is cancelled and is operating at 8WK. 8BJB and 8AGI are new ORS. SAUL worked KDGL, S.S. Steel Ranger out of Balboa headed for the Orient. 8CDV is holding his own with PRR and AA. 8BJB is working on tuned grid and plate set. 8AGI is getting all over the country with a new 50-watt set. 8BJG worked oa-2RX. 8AWV held a hamfest. 8BXP worked Germany with 250 volts on plate of a UX-112. 8CYR is playing with a mercury arc rect. 8ACZ is on 40. WWVA, the

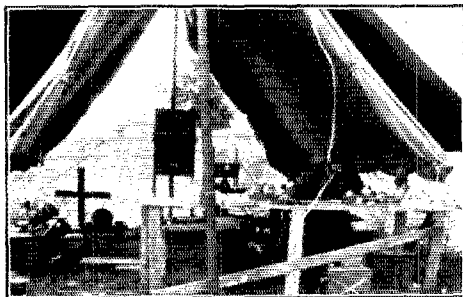

CV-6, THE CAMP CHARNOCK 100-WATT 500-CYCLE STATION AT CHARLESTON, W. VA.

8AMD and 8CBR operated this outfit for several weeks last summer with good results. Sgt. Murrill (8AMD) is at the key in the photograph.

Wheeling broadcast station, belongs to 8ZW. Several stations failed to report, some of which have not reported for several months. Remember, OMs, a report a month or . . .

8BNF was heard in England on a 7½ watter 8VZ (ex8AYP) made a good total this month.

Traffic: 8VZ 481, 8AGI 111, 8BSU 10, 8ACZ 45, 8CXP 2, 8AWV 1, 8BJG 16, 8BJB 9, 8CDV 15, 8AUL 18.

NORTH CAROLINA—SCM, R. S. Morris, 4JR—4MI has discarded his crystal and is now using a couple of 210s in an MO-PA circuit and gets out just as good as he did with the fifty watter. 4GW is using two 250 watters in an MO-PA circuit—watch your ears. 4RY has put in a 50 watter and is now working some DX. 4BX has been QRW radio business at the store but he hands in a little traffic even then. 4PR is using remote control and works lots of sizes but little traffic. 4TS has trouble with his S tubes. 4PP is getting out FB with a five watter and is trying to arrange schedules. 4SJ was going fine until some kids stole his rectifier elements; now he is using a.c. 4OH is going strong with a 210 and a.c. 4RI raised his antenna with improved results. 4JR is on daily with crystal control on 78 and 39 meters.

Traffic: 4MI 102, 4JR 62, 4PP 31, 4RY 23, 4SJ 12, 4TS 12, 4GW 12, 4BX 9, 4OH 9, 4RI 2, 4PR 1.

ROCKY MOUNTAIN DIVISION

COLORADO—SCM, C. R. Stedman, 9CAA—Denver: 9CAA has three schedules now and they are working fine as the traffic total shows. 9EAM has a schedule with 5APG. 9CJY put up a new antenna, but says that he can't raise NZ yet. 9QL is on 20 meters, but reports things rather slow there. 9CJP has been laid up with scarlet fever all month and is just getting out now. 9DSY had a schedule with a 5, but he says he can't seem to get QSO. 9DWZ has a new aerial and says he is getting out 100% better. He is having trouble with a power leak at night, tho. 9CAW tried two tubes in parallel and says it's the worst yet. His young brother gave him a rattle for Xmas with the result that it (the brother) went out the window. 9DED is on the air on 20 and 40 meters. 9DKM put up a new Hertz and says it works FB. 9CBH, is getting out well on 80 meters. 9EEA has been on in spite of being very QRW with business. 9DGJ sends in his first report. 9CDW says not much doing as he is very busy. Hi!!

9DVL had his bats and rectifier freeze up and he shot all his tubes. Hard luck, OM. 9AOI is on 40 and 80 and says he can work anything in the U. S. 9BYC says he is ashamed that he isn't doing better traffic work, but he spends too much time experimenting. Look at his total, tho.

9CDE is having a lot of QRM from wires rubbing against trees. Hi. 9ADI is doing good work on 40 and 80. 9DUI just got over the flu and is on with 10 watts. 9AE tried to see how many foreigners he could work during the month. He helps BCLs to get in shape.

Traffic: 9CAA 810, 9EAM 79, 9CAW 82, 9DWZ 33, 9DGI 7, 9DSY 5, 9CJP 25, 9QL 2, 9CJY 23, 9DKM 23, 9DED 12, 9DUI 32, 9EEA 21, 9ADI 21, 9CDE 32, 9BYC 60, 9AOI 10, 9DGQ 33, 9EAE 66, 9CDW 8.



CANADIAN 3RV IS A HIGH SCHOOL TEACHER. (HIGH STUDENTS NEEDING HELP WITH STUDIES ARRANGE SCHEDULE WITH 3RV ANY NITE AFTER 11:30 HI!)

UTAH-WYOMING—SCM, Art Johnson, 6ZT—6A1K is now the one active station in Ogden. Schedules are kept with 9CKQ on 41 meters. 6CVA (also on 41) keeps regular schedules with 9EEA, 9BJK, 7EF, 9AON, 6AGD and 7MP. QRA PR9C that he worked? 6RM handled a bunch of Christmas greeting messages. 6RV handled the largest number in this territory making the BPL. For the good work, see Traffic Briefs, FB, OM!

Although Mr. D. C. McRae, 6RM, has been appointed SCM, 6ZT is finishing out the year of 1926 in this capacity. It has been a great pleasure for him to serve the League in this office and he is sorry that it was necessary for him to resign. He wishes to thank all for their fine cooperation and hopes they will aid his successor in a like manner so that he may do justice to the position he has been elected to. Send him your report, OM.

Traffic: 6A1K 9, 6CVA 30, 6RM 49, 6RV 157.

SOUTHEASTERN DIVISION

FLORIDA—SCM, W. F. Grogan, 4QY—Some fine reports were sent in this month by 4DD, 4BL and 4OB. 4DD leads the state this month. FB! 4BL helped 5IB, an Army station, get traffic to WVR in quick time. 4OB blew two fifties. Hard luck, OM. 4LG, ex 9CLG, sends in a good report. 5AAF and 8CTS are operating at 4LG. 4LK says South Florida is sure FB. 4CK and 4FM are the only active stations in Miami at present. Where is 4VS? Let's hear from you. 4XE reports working phone with N. Y. From the amount of reports received,

it looks like most of the boys had too much Xmas and forgot to send in a report. 4CH reports that he lost all his junk in the Sept. storm but hopes to be on again soon. 4OO sends in for an ORS. He is ex 2AQY.

Traffic: 4DD 210, 4BL 174, 4OB 143, 4LG 68, 4LK 58, 4CK 25, 4XE 24, 4TK 15, 4QY 2.

ALABAMA—SCM, A. D. Trum, 5AJP—The year of 1926 showed much activity in Alabama, and our hams are to be congratulated on their splendid spirit of cooperation, good operating, and traffic-handling as well as their excellent DX. We want to proceed with the spirit of the time and continue to hold our supremacy in amateur work and make 1927 a far better year for amateur good.

Mobile has been doing splendid work under the leadership of 5DL and many new amateurs are forthcoming. 5AC is back and in old-time shape. 5AAD is installing remote control and break-in. Montgomery is holding her own in the good work of the embryo stage. Birmingham has developed some fine amateurs this fall and big things are expected of 5DT as well as the rest of the new gang. 5AC takes the credit for being the most consistent ham for the year. Dothan is becoming active again and 5ASR is showing his stuff. 5AV is stirring activity in Selma and says he hopes to have that town on top for good operating. Auburn has produced many good stations this year and it is hoped that much activity will result. The old form that used to be at 5XA is seen in 5DI and 5WI with the splendid support of the many others.

Traffic: 5AAD 5.

GA—SC—Cuba—Isle of Pines—P.R.—SCM, H. L. Reid, 4KU—4KL and 4SI are doing nice work. 4AAH is the most RELIABLE Atlanta station and open for your traffic. He made the BPL and put our Section on the map. 4AAM-4PG recently helped WVR and NAO to make contact—a fine piece of A.R.R.L. cooperation. All active amateur stations in the Section are urged to get in touch with the SCM (see address on page 3, QST) with a monthly report for each QST—more real ORS and OBS are needed. Get in touch with the R-M in your part of the Section and boost traffic.

Traffic: 4AAH 158, 4IT 32, 4AAM 33, 4PG 6.

WEST GULF DIVISION

OKLAHOMA—SCM, K. M. Ehret, 5APG—5DQ has received his ORS and from the report he turns in this month, it looks like business was picking up with him. 5ADO reports work nearly got the best of him and he hasn't had much time for radio. 5EQ is a new one coming into the traffic game and is making a good start for his report. 5ASK drew a goose egg. Too much campus—a YL—a bright moon. Hi! Looks like 5ANL landed in the square again this month, also he has been having transmitter trouble. 5APG managed to slip in the square too by the exertion of an alarm clock and a couple of schedules. 5SW worked LW off the coast of Florida. 5QL and 5AAV are having good luck on 20 meters. 5ARD has a Western Electric 50 perking. 5ZAV finished his chemical rectifier and was QSO Jamaica. 5AGN handled a few during the Christmas vacation. 5AMO bought 5QL's German 30-watter and his traffic total shows the results. About forgot 5ABO who is on 180 meters with fone.

Traffic: 5APG 116, 5AMO 175, 5ANL 135, 5DQ 50, 5ADO 35, 5AEQ 7, 5AGN 15, 5SW 22, 5ABO 2.

NORTHERN TEXAS—SCM, W. B. Forrest, Jr., 5AJT—This month was our best this year from the number of msgs handled. There is plenty of good traffic, but the SCM has had several complaints from out-of-state stations saying that they can't move traffic into Northern Texas. Most of the traffic seems to be on 80 meters so keep a lookout for Texas traffic. No news of especial interest is available this month, also the page could be filled easily with the DX reports from various stations. We have several new stations reporting this month. FB.

Traffic: 5AKN 8, 5AMT 13, 5AKG 16, 5AJF 67, 5AQ 32, 5APO 172, 5WW 32, 5HY 8, 5ACL 23, 5SP 21, 5RG 11, 5SH 10, 5JH 2.

SOUTHERN TEXAS—SCM, E. A. Sahn, 5YK—Reports are few this month, probably due to the holidays. There has been considerable activity, however. 5AHP of Lynchburg sent his report while on the train. That's the spirit, OM. Fred Kush, 5HS says he is QRW with the Xmas holidays. 5HE of San Antonio has made some good DX records this

month and also handled his share of traffic. 5HC is our new OBS. Let him know if you copy his broadcasts. The Wilsons of Brownsville turn in a good total, though on only about five nights using a 250. They say traffic is plentiful. Let's have more reports of this kind in the new year.

Traffic: 5EW 27, 5HC 3, 5HE 12, 5AHP 6.

CANADA

MARITIME DIVISION

NOVA SCOTIA—SCM, W. C. Borrett, 1DD—Considerable amount of QSO's this month among Maritime stations have taken place at noon hours. 1CO of P.E.I. works N.S. stations every chance. N.S. stations have mostly been in the 40-meter band as QSO on 52 seems very scarce and owing to the fact that we cannot work U.S.A. stations when using that wave. 1DQ, with his new Hertz, is tickled with results on 40 and 20 working all kinds of stations. 1DA has worked France with a 201-A. 1CX has schedule with 8AW and asks that all Newfoundland traffic be directed to him. 1AE certainly had fine training in Ontario. He sends in the most interesting reports every month even though he has had the hard luck of losing his new 50-foot pole and has to start all over again with new antenna. 1DD is still pounding out with his Hertz on the 40-meter band. He is going to build a new one as soon as possible for 52 meters and stay on 52 all the time. Who else in Maritime is willing to do the same? 1DJ was heard pounding away again this month. 1AC has the finest looking antenna of the Maritimes—a copper drain pipe. As soon as the next issue of QST is published, the winner of the Maritime Murphy Cup will be decided for 1928. By the way, gang, how about a convention for 1927? Where do you want it. St. John or Halifax or elsewhere? Please write 1DD at once.

Traffic: 1CX 5, 1DD 2, 1DM 1.

NEW BRUNSWICK—SCM, T. B. Lacey, 1EI—Things last month went pretty good. 1AK got a new tube for the old one he lost. 1AI just got home from the hospital. 1AQ worked Belgium.

Traffic: 1AM 10, 1AK 10, 1AQ 12, 1AD 5, 1EI 3.

PRINCE EDWARD ISLAND—SCM, W. A. Hyndman, 1BZ—1AJ is a new station in Summerside ready for traffic but not yet an ORS. 1CO has schedules with nclAR and nclAX and is doing good work. 1BZ is on the air from 6.30 to 8.00 p.m. nearly every evening.

Traffic: 1CO 12.

QUEBEC DIVISION

QUEBEC—SCM, Alex. Reid, 2BE—It is really wonderful to see the interest shown by the boys during the past month. It seems like old times again. Sunday mornings you will find five or six of the boys using fone on 180 meters and every evening you will hear them from five to ten on the 40-meter band. There has been more traffic moved during the past two months than ever before from this Section. The SCM has been advised from Quebec City that there will be two active stations on the air before the end of Jan. This is what we have been waiting for for the past two years. The monthly hamfest was held at 2CM's station, the attendance falling down a little on account of the cold weather. 2AX has gone over to crystal and is doing very good work with 10 watts input. 2FO blew out a 50 watter but is back again with a new M.T. 6. 2OD and 2BB are doing good DX and both have schedules. 2BB is prepared to handle all traffic for the Maritimes. 2AL and 2BG worked Australia during the month. 2BV knows what it feels like to receive 1500 volts. As a result, he is nursing a badly burned hand. 2BI has come to life after a year's absence. 2AU is very active and is doing lots of daylight DX. There will be two new stations on the air soon. 2BM has rebuilt and is using a 50 watter. 2BE, 2HV and 2CC are active as usual.

Traffic: 2AU 26, 2AK 10, 2AX 15, 2BB 9, 2AL 5, 2BE 14, 2BG 11, 2BV 14, 2DO 5.

ONTARIO DIVISION

ONTARIO—SCM, W. Y. Sloan, 9BJ—It is gratifying to notice the number of stations that are gradually making use of our 52.5-meter wave. Stations right across to the Western coast are heard not only

Wednesday but every night on this wave. Ontario, with perhaps the exception of the Southern Dist., is well represented.

The SCM would like to take this opportunity to thank the gang throughout the Section so kindly extended to him their good wishes during the Christmas festivities.

Northern Dist.: 3NI is camped on 20 meters during the daytime, and is working all over the states. nu-8ACY was a visitor at 3NI lately, and was QSO with him five days later from his own home station. 9AQ turns in a nice traffic total this month. He and 9AI work a lot on 50 meters flat. They will listen for replies on 52.5 while they are using this wave.

Eastern Dist.: 3JL prances off with the traffic honors in this Dist. 3MP is tickled with his new Hertz antenna and declares it is the best yet, and he has worked several European countries this month. 3JW is fooling around the low-power stuff with a 201-A. 3XM is operating a station of mourning, as his lone fifty watter has gone to the happy hunting ground.

Southern Dist.: 3CS again cops the traffic honors in this neck of the woods. He has recently been appointed CM and OBS. We welcome the return of old 3BG. His 50-watter on 80 meters should be a great help in clearing traffic for Western Ontario points. 3UD and 3CM, two new ORS, are keeping things humming. A new arrival, 3CB, is on the air using the 80-meter band. Welcome, OM. 3DH, who was home from college during the holidays, kept the old hook warm.

Central Dist.: The gang at Hamilton is having their style cramped by a bothersome power leak. 3BZ is now using 80 meters. 3HR says he thinks he will rebuild. 3HT is heard working occasionally. 3AI is now the second op at 3BT. 3EL features the news from Toronto this month. He has been successful in clicking with an Aussie with his five watter. 3FC who has long played a lone hand in Australian QSO. from Toronto, now has to share the honors with 3EL. 3FC maintains his schedules with ei-ACD and eg-5HS. The latter is on 22.7 and is eager for QSO with the gang. Hill was back again in Regina for the holidays. 3BL insists that if you want traffic to move with alacrity, to let him get his hands on it. 3AZ is down with the 20-meter gang and is busy building a new receiver. 9AL turns in his usual consistent traffic report, due to his reliable schedule.

Traffic: 3FC 65, 3JL 52, 3CS 49, 9AQ 47, 9AL 30, 3BT 21, 3FU 12, 9BJ 11, 3AZ 3, 3UD 7, 3CT 5, 3IA 4, 3EL 4, 3NI 2, 3MP 3, 3AFP 2, 3BL 2, 3BZ 2, 9AG 2.

VANALTA DIVISION

ALBERTA—SCM, A. H. Asmussen, 4GT—4AF keeps the junk perking altho away most of the week. 4AL is back on the job and gets good DX reports. 4AH has his crystal transmitter all ready and expects his H tubes soon. 4CS is trying for a commercial ticket. 4AX is QRW with his YWCA work. 4DQ is the star DX station of his Section for the month—the OW was heard in Europe and has also worked Jamaica. 4EB has his transmitter going in good style. Looks like we are going to have some real stations going in Alberta. 4DG also is a new one. 4HM sure has a swell layout and is doing nice work. 4IO was after big game and came back with a Dear. He is heard on 40 and 80. 4GT spends his spare time trying all types of antennas at his new QRA. 4BN is another new station on low power.

Traffic: 4AF 19, 4DQ 5, 4GT 7.

BRITISH COLUMBIA—SCM, E. S. Brooks, 5BJ—British Columbia is becoming active once more but the SCM would like to receive more replies to his circular letter of Dec. 6. 5GO heads the traffic list and also kept a schedule with KQGI, bound for China and Japan. 5RN keeps a schedule with nu-6BHH. 5CT says 80 meters has lots of sigs but no traffic. 5BJ is

Traffic: 5GO 21, 5RN 6, 5AU 5, 5AC 3, 5BJ 3. trying to get out with 5.5 watts input on a 201-A. 5CP has turned BCL.

PRAIRIE DIVISION

SASKATCHEWAN—SCM, W. J. Pickering, 4FC—4AC does lots of fone work on 172 meters, getting out FR. 4BF has moved to Saskatoon and left all his junk at Moose Jaw. 4CB has a crystal-controlled set now which will be going soon. He complains of a scarcity of 4th dist. stations on 52.5 meters. 4AV is back on the air with a 201-A and has been heard working on the 80 band. 4FH is heard on the air occasionally but can't QSO anyone. 4FC is bothered by cold weather in his shack and not on much.

Traffic: 4CB 7, 4AC 44, 4FC 2.

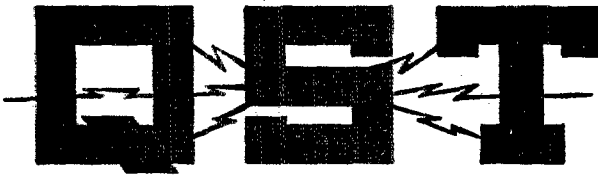

A Magazine Devoted Exclusively to the Radio Amateur

INDEX TO VOLUME X

1926

Published as a supplement to QST
for February, 1927, Vol. XI, No. 2

INDEX TO VOLUME X

1926

AMATEUR RADIO STATIONS

ARRL Standard Frequency Station 1XM	45, June
Correction	40, July
Australian 5BG, Clarence Park, South Australia	43, July
Canadian 4GT, Calgary, Alberta	50, June
New Zealand 2XA, Wellington, N. Z.	50, Dec.
1AAE, Pittsfield, Mass.	40, Oct.
1AOP, Greenfield, Mass.	41, July
1AXA, Plymouth, Mass.	45, Aug.
1BAY, Cambridge, Mass.	49, Feb.
1XV-1KAN, Round Hills, South Dartmouth, Mass.	42, Nov.
2AHM, Schenectady, N. Y.	43, Aug.
2CXL-2XBB, Fort Monmouth, N. J.	51, May
3AAL, Alexandria, Va.	38, Oct.
3LW, Willow Grove, Pa.	46, Sept.
3VX, Audubon, N. J.	51, Dec.
4BY, Savannah, Ga.	49, June
5AKN, Dallas, Texas	39, Oct.
5LG-5SC, Alamogordo, New Mexico	50, Feb.
6BJX, Los Angeles, Calif.	48, Sept.
6BUR, Whittier, Calif.	45, Jan.
6HM, Carmel, Calif.	49, March
6OI, Stanford University, Calif.	42, July
7AY, Eugene, Oregon	51, June
7IT, Portland, Oregon	52, Dec.
8RX, Detroit, Mich.	47, Sept.
Rochester, N. Y., 8PZ, 8DQA, 8BGN, 8CUI, 8BRD, 8BEN, 8KS, 8ALY, 8DSI	49-51, April
8NY, Hartford, Conn.	48, Feb.

AMATEUR REGULATIONS AND LEGISLATION

Brazil:	54, April
Canada: Canadian Wavelengths	46, Aug.
Chile:	47, Aug.
Denmark:	68, July
Germany:	52, March
New German Call System	48, Nov.
Mexico:	54, July
United States: Legislative Note (K.B.W.)	26, July
New Phone Band Authorized (K.B.W.)	8, Feb.
Radio Legislation Pending (K.B.W.)	44, March
Re: amateur QSO with naval stations	58, Feb.
Roll Over (Editorial—K.B.W.)	7, March
Stray:	20, May
The Fourth National Radio Conference (Warner)	33, Jan.
The Problem of Regulation (Editorial—K.B.W.)	7, June
Warning (re: Hertz antenna)	27, Jan.

AMPLIFIERS—AUDIO AND RADIO

Amplifier Ins and Outs (Burke)	25, June
A New Reflex Circuit (Hatty)	17, Jan.
A Power Amplifier for the Low-Power Transmitters (Turner)	29, March
A Reflexed Receiver with Resistance Audio Coupling (Hatty)	23, May
A Resistance Coupled Amplifier	45, Feb.
A Short-Wave R. F. Amplifier (Bouck)	26, Nov.
Devising a Shielded Receiver Kit (Silver and Clough)	27, Dec.
Multi-Purpose Shielded Units (Henderson)	29, Sept.
Neutralizing the Crystal Amplifier	36, March
Peaked Audio Amplifiers (Kruse)	29, April
R. F. Amplification—A Re-Hash (Lyford)	14, Nov.
Shielded R. F. Stages (J.M.C.)	41, Sept.
Short-Wave Receiving Sets (Hatty)—includes data on tuned audio amplifiers	21, July
Super-Regeneration at 5 Meters	37, July
The Making of a Single-Control Receiver (Blatterman)	17, April

ANTENNA SYSTEMS

Antenna-Counterpoise Fundamentals (H.P.W. and J.M.C.)	46, May
Cage Antenna Hoops (J.M.C.)	45, Nov.
Feeding the Antenna (Kruse)	3, July
Horizontal Reception (Kruse)—includes antenna data	9, Feb.
Low-Loss Lead-Ins (Tennant)	62, May
Picking a Good Antenna for the Short-Wave Station (Starr)	27, May
Straightening Out the Antenna (Melton)	30, Aug.
Super-DX with Indoor Antenna (Simmonds)	58, Sept.
The Length of the Hertz Antenna (Lang)	16, Oct.
Warning (re: use of Hertz antenna)	27, Jan.
When the Antenna Halyard Breaks (Hallman)	17, Feb.

ARMY-AMATEUR COOPERATION

Army-Amateur Notes:	I, April
	II, May
	II, June
	49, July
	II, Sept.
	III, Oct.
	IV, Nov.
	II, Dec.
Captain Rives Leaves	56, Sept.
Our Army Affiliation (Saltzman)	60, Feb.
The Army Network (Saltzman)	56, March
Traffic Brief	11, March

BATTERIES AND BATTERY SUBSTITUTES

A Dry Electrolytic Rectifier (Kruse)	30, May
A Good Hydrometer	38, Feb.
Battery Substitutes (Kruse)	23, Feb.
Operating Receiving Filaments Without Batteries (Kruse)	25, Aug.
The "A" Substitute Problem (Roeder)	23, Aug.
The Epom Rectifier and Filter (Kruse)	41, Jan.
Welding Edison Elements (Eger)	19, Nov.

BETTER OPERATING PRACTICES

As Others See Us (Elsner)	32, Dec.
Break-In and Remote Control (Clayton)	9, Sept.
Diagram Correction	33, Nov.
Bugs (Handy)—hints on operation	61, May
Cheap Logs (Thatcher)	49, Oct.
Check Your Messages (Peacock)	11, Feb.
Checking the Tone and Wavelength of Transmitters (Clapp)	19, Dec.
Good Dope (Hill)	55, Jan.
How Do We Get This Way? (Long)	1, Dec.
How to Check Radio Messages (F.E.H.)	39, May
"It Won't Be Long Now" (Editorial—K.B.W.)	7, July
More on QSL's (Davis)	54, Nov.
On Improving Operating (Stedman)	III, May
Please Heed This (Doane)—re: bug sending	55, Jan.
Poor Operating (Fass)	56, March
"Pse QSL Card" (A.L.B.)	37, March
QSL (Walleze)	49, Oct.
QSL Cards (Leuck)	54, Jan.
Reducing Power for Local Work (Turner)	33, Oct.
Reviewing Our Traffic Situation (Cate)	11, Jan.
Roll Over (Editorial—K.B.W.)	7, March
Rotten QSR (2ALA)	63, June
Rotten Sign-Offs (Editorial—A.L.B.)	7, April
Simplifying Operating (J.M.C.)—re: use of bug keys	21, May
Slow 'em Down (Pate) re: bug operation	67, Aug.
Standard Calling Method (Briggs)	59, March

Stay Where You Belong Gang (Freire and Lacombe)	59, April
The CQ Problem (Lamb)	1, Dec.
The Five Point System (Editorial—K.B.W.)	7, Nov.
These Rough Notes	48, April
Warning!	1, April
Who Gets Those Messages? (Huber)	111, April

BOOK REVIEWS

Annuaire International de la T.S.F. (Chiron)	19, Nov.
Elements of Alternating Currents and Alternating Current Apparatus (Beaver)	13, Nov.
Establishment of Radio Standards of Frequency by the Use of a Harmonic Amplifier (Bureau Std. Paper No. 530)	31, Dec.
Gedenboek N.V.V.R., 1916-1926	18, Nov.
Guia Radio (Revista Telegrafica)	18, Nov.
Les Filtrés Electriques, Theorie, construction, applications (David)	18, Nov.
Practical Radio and the Testing of Receiving Sets (Moyer & Wostrel)	32, May
Radio Communication (Stone)	30, July
Radio Frequency Measurement (Moullin)	31, Dec.
Safety Rules for Radio Installation (Bureau Stds)	31, Dec.
The International Amateur Radio Call Book	8, Feb.
Wireless Telephones and How They Work (Ersikine-Murray)	8, Feb.

BREAK-IN SYSTEMS AND REMOTE CONTROL

A Break-In Relay (Brainerd)	34, Dec.
A.C. Relays (Westman)	42, Feb.
A Sensitive Vacuum Tube Relay (Hoffman and Schnell)	20, Nov.
Break-In (Mason)	52, Nov.
Break-In and Remote Control (Clayton)	9, Sept.
Diagram correction	33, Nov.
Break-In With Motor Generator Supply (Walleze)	63, Dec.
Concerning Break-Ins (Stinson)	65, Dec.
Ford Radio Apparatus (Smith)—with relay dope	59, April
Good Break-In Dope (Hood)	57, March
Non-Chattering A. C. Relays (Hayes)	60, April

CALCULATING CHARTS

Antenna-Counterpoise Fundamentals (H. P. W. and J. M. C.)	46, May
A Simple Wavelength Chart	16, Jan.
Condensers in Series (Hitchcock)	23, April
Easy Tuner Design (Baird)	26, Sept.
Finding the Inductance of the Filter Choke (Berry)	39, March
The Length of the Hertz Antenna (Lang)	16, Oct.
Transmitting Coils (Handy)	29, July
Tuner Design	42, March
Wavelength-Frequency Conversion Chart	25, Oct.

CALLS HEARD

51, Jan.
55, Feb.
56, April
57, May
58, June
44, July
50, Aug.
49, Sept.
41, Oct.
46, Nov.
54, Dec.

COILS

Buying Inductances by the Inch (J. M. C.)	42, June
Coil Cement	47, March
Coil Construction (Hennessy)	60, April
Easy Tuner Design (Baird)	26, Sept.
Good Helix Construction	25, Jan.
Inductance Clips	27, Jan.
Lower-Loss Inductances (J. M. C.)	34, April

New Interchangeable Coils (J. M. C.)	31, Nov.
Paper Tape on Coils	47, March
Plug-In Chokes	38, Oct.
Plug-In Choke Coils	42, March
Plug-In Coil Tuners (J.M.C.)	46, April
R. F. Chokes (J. M. C.)	19, July
Stray: re: transmitting coil supports	51, April
Stray: re: coil support	19, July
Transmitting Coils (Handy)	29, July
The Shielding Problem (Clemons)—with coil data	9, March
Correction	58, April
Tuner Design	42, March
The R. F. Choke Puzzle	44, Sept.

CONDENSERS

A Low-Capacity Variable Condenser (J. M. C.)	20, March
A "Midline" Condenser (J. M. C.)	40, Nov.
A New S. F. L. Condenser (J. M. C.)	41, May
A Simple Wavelength Chart (Etkin)	16, Jan.
A Single-Control Rig (J. M. C.)	47, Feb.
A Straight Frequency Line Condenser (J. M. C.)	24, Oct.
Capacity in Micromicrofarads (Turner)	14, Aug.
Concerning the (grid) Condenser (Raven-Hart)	63, Dec.
Mr. Hairy's Reply (Hairy)	64, Dec.
A Comment from General Electric (Warper)	84, Dec.
Condensers in Series (Hitchcock)	23, April
Easy Tuner Design (Baird)	26, Sept.
Fixed Air Condensers (J. M. C.)	11, Aug.
For Short-Wave Tuners (J. M. C.)	46, March
Grid Condenser and Leak Mounting (J. M. C.)	19, Oct.
High-Power Transmitting Condensers (J. M. C.)	14, July
New Condensers (J. M. C.)	34, May
New Fixed Condensers (J. M. C.)	36, Sept.
New Variable Condensers (J. M. C.)	21, Aug.
Novel Straight Frequency Line Condenser (J. M. C.)	23, March
Tuning Tricks (Mueller)—re: condensers	22, Aug.
The Shielding Problem (Clemons)—includes condenser data	9, March
Correction	58, April
The Uses of a Calibrated Variable Condenser (Roof)	28, Nov.
Transmitting Condensers	49, Dec.
Voltage Breakdown in Transmitting Condensers (Smith)	42, Dec.

CONTESTS—TESTS—RELAYS—RECORDS

Amateur Radio to the North Pole Again (Schnell)	33, March
Australian Two-Way Reliability Tests: Announcement	1, May
Report	52, July
Report	56, Aug.
Easy Money for Ham Tuner Designs (K. B. W.)	33, Feb.
General Electric Tests	47, May
General Electric Short-Wave Tests Results (Prescott)	9, Nov.
Interesting Transmission Tests	47, May
KPHW and the Trans-Pacific Yacht Race (Wainwright)	41, Dec.
Navy-Day Telegraphic Broadcasts: Announcement	11, Oct.
Navy Day Honor Roll	11, Dec.
South Schenectady and the April Tests	38, June
The Cruise of NRRL Aboard the U.S.S. Seattle (Schnell)	9, Jan.
The Mid-Summer Short-Wave Tests (Handy) Report:	1, Jan.
The 1926 Cooper Cup	41, March
The South Schenectady Tests (Young)	38, April
Three More Cups Offered (Warner)	8, Feb.
The Traffic Trophy:	111, Jan.
VI, Nov.	
IV, Dec.	
SGZ Wins Jewell Contest (Miller)	23, July

CONVENTIONS

Atlantic Division Convention at Buffalo: Announcement	16, May
Report (A. L. B.)	52, Aug.
Central Division Ohio State Convention: Report (A.A.H.)	30, Jan.
Central Division Ohio State Convention: Announcement	37, Aug.
Report (A.A.H.)	15, Oct.
Central Division Michigan Convention: Announcements	38, Feb.; 8, March
Report (A.A.H.)	49, May
Central Division 3rd Annual Indiana State Convention: Announcement	28, June
Report (A.A.H.)	46, Sept.
Central N. Y. State (Atlantic Div'n) Convention: Announcement	35, Aug.
Report (A.A.H.)	49, Oct.
Come to the Hudson Division Convention (K.B.W.)	8, May
Report: The Hudson Div'n Puts It Over (K.B.W.)	33, July
Convention Success (Wallace)	39, Aug.
Dakota Division Convention: Announcement	47, Feb.
Report	13, April
New England Division Convention at Providence: Announcement	24, April
Report (A.A.H.)	52, June
Northwest Division Convention: Announcement	22, Oct.
Report (K.B.W.)	8, Dec.
Pacific Division, Southern Section, Hamfest: Report (6CHZ)	57, June
Pacific Division Convention (San Jose): Announcements	19, Sept.; 43, Oct.
Second District Convention (Announcement)	38, March
Report (Foster)	20, Dec.
The First All-Canada Convention: Report (A.A.H.)	36, Jan.
The Maritime Division Convention: Report (J.M.C.)	48, June
The West Gulf Division Hamfest: Report (Bennett)	39, June

COUNTERPOISE AND GROUND SYSTEMS

Antenna-Counterpoise Fundamentals (H.P.W. and J.M.C.)	46, May
—for Horizontal Collectors	14, 15, 16, Feb.

CRYSTALS

(See: Transmitters—Crystal Control)

EDITORIALS

(Written by K.B.W. unless otherwise stated)	
A Job for the Clubs	7, Oct.
Democracy	7, May
Editorial	7, Dec.
Going Up	8, Jan.
Ho for Experimenting!	8, Jan.
"It Won't Be Long Now"	7, July
Looking Backwards a Bit	7, Feb.
Loyalty	7, Sept.
Making These Brasspounders	7, Jan.
Our Handbook	8, Oct.
Part of the Game	7, Aug.
QRX for QRR	8, Jan.
Roll Over	7, March
Rotten Sign-Offs (A.L.B.)	7, April
The A.R.R.L. Spirit	7, April
The Five-Point System	7, Nov.
The Fieldman's Trip	8, Oct.
The I.A.R.U.	7, Sept.
The Libraries	7, Aug.
The Lust for DX	7, May
The Problem of Regulation	7, June
The Recommendation Factor	7, Jan.
To Newsstand Readers	7, Aug.
We Advance	7, July
Winter	7, Oct.

EMERGENCY AND RELIEF WORK

Amateurs Help in Florida Emergency	III, Nov.
Emergency Power Supply	I, Dec.

Medals for Conspicuous Radio Service (K.B.W.)	29, May
PRR (Budlong)	35, May
PRR (Johnson)	64, June
QRX for QRR (Editorial—K.B.W.)	8, Jan.

EXPEDITIONS

Amateur Radio to the North Pole Again (Schnell)	33, March
ANK	55, May
Byrd Arctic Expedition Sails (K.B.W.)	32, May
Contact with Expeditions	I, Oct.
dg1XL, University of Michigan Greenland Expedition (Oscanyan)	47, Dec.
Expeditions (Includes reports on most expeditions during year)	53, Aug.; IV, Nov.
GMD	V, Dec.
High Adventure in the Northland (K.B.W.)	22, June
More Arctic Adventure	17, July
North of the Arctic Circle with VOQ (Manley)	I, Nov.
Progress of the Wilkins Expedition	33, May
Short-Wave Radio in the Antarctic (Jenssen)	12, Aug.
The Cruise of NRRL Aboard the U.S.S. Seattle (Schnell)	9, Jan.
The Month with Expeditions	I, Oct.

EXPERIMENTERS' SECTION

	40, Jan.
	37, Feb.
	45, March
	38, April
	47, May
	33, June
	38, July
	41, Aug.
	44, Sept.
	27, Oct.
	45, Dec.

FICTION

As Others See Us (Elser)	32, Dec.
Grasshopper Radio (Garmhausen)	42, May
"Ham" (Tamm)	26, Oct.
How Antennaz Shirk (Everest)	33, April
"Rotten Radio"	27, July
The Berkshire Brass Pounders (Everest)	26, Jan.
These Here Antenna Masts (9AIQ)	58, March
The Price of Peace (Peacox)	34, Nov.
The Taurenwerfer Beam (Taurenwerfer)	40, June

FILTERS

Filtering the Synchronous Rectifier (Hoover)	35, Feb.
Finding the Inductance of the Filter Choke (Berry)	39, March
Ford Coil Filters (Provins)	43, March
—for Battery Substitutes	23, Feb.
Operating Receiving Filaments Without Batteries (Kruse)	25, Aug.
Taming the Synchronous Rectifier (Kruse)—contains filter data	9, May
The Epom Rectifier and Filter (Kruse)	41, Jan.

FIVE METER TRANSMISSION AND RECEPTION

5 Meters	40, Jan.
5-Meter Antennas	44, Sept.
5-Meter Progress	44, Dec.
5-Meter Sets	44, Sept.
5-Meter Tests	39, July; 44, Sept.; 27, Oct.
A New Record	27, Oct.
C. H. West's Transmitter and Receiver	45, Dec.
Concerning 5-Meter Receivers	27, Oct.
Field Tests	46, Dec.
Getting Down Below 5 Meters (Lyman)	23, Jan.
International 5-Meter Tests	41, Aug.
Progress and Plans at 5 Meters—and Below (Kruse)	34, July
Sending Sets (5-meter)	41, Aug.
The 2AUZ Work	44, Dec.
The Need for 5-Meter Wavemeters	27, Oct.
The West Receiver	45, Dec.

I. A. R. U.

Emblem Design	58, Dec.
I. A. R. U. News:	
47, Jan.	
51, Feb.	
52, March	
52, April	
54, May	
53, June	
68, July	
46, Aug.	
52, Sept.	
44, Oct.	
48, Nov.	
57, Dec.	
Important Changes in the I.A.R.U.	57, Dec.
The I. A. R. U. (Editorial—K.B.W.)	7, Sept.

LOOPS

Amateur Wavechangers (Clapp)—contains loop data	35, April
The Flying Loop (Wright)	36, Nov.
Diagram correction	53, Dec.

MASTS

A Zero Weather Mast (R.S.K.)	34, Feb.
Constructing and Erecting a Steel Mast (Briggs)	21, Oct.
The Mast at 8LO (Brainerd)	41, Nov.
When a Guy Wire Breaks (Hoover)	17, Dec.
When the Antenna Halyard Breaks (Hallman)	17, Feb.

METERS

A New Voltmeter	32, Sept.
Cheap Measuring Instruments (Lang)	17, Oct.

MISCELLANEOUS

A New Illuminated Dial (J.M.C.)	23, Oct.
Another Mystery (Turner)	33, Aug.
A Two-Speed Vernier Dial (J.M.C.)	32, July
Aurora Investigation (Henry)	62, Dec.
Aurora and Its Effects Upon Radio Signals (Sutton)	23, Oct.
A Vacation Possibility	50, May
Communications Department Elections. Easier Tuning (J.M.C.) re: dials	32, Feb.
Elections: For Board of Directors (1925) For 1925 (Notices)	39, Jan.
22, Sept.; 22, Oct.	
Entering Radio Engineering (Kruse)	44, Feb.
Field Strength Measurement	44, Sept.
Financial Statement:	23, April; 32, July; 8, Sept.
Increase in ARRL Dues (K.B.W.)	24, April
Isolantite—A Unique Material (Lescaubour and Kruse)	14, April
Metalized High Resistance Units (Morgan)	37, Sept.
More QRN Storms (Eccles)	58, March
Signal Corps Training in Citizens Military Training Camp (Rives)	47, April
Some Changes at HQ's (K.B.W.)	30, March
Some More Changes at HQ's	26, April
Sulphur Insulation (Briggs)	62, June
The Board Meets (K.B.W.)	27, April
The Modesto Radio Club's Housewarming (Brown)	25, April
Turnbull's Field Strength Set	48, May
Vacuum Resistances (J.M.C.)	13, Sept.
6XBR, 108 Meters (Shaw)	31, March

OBITUARY

Cantin, Kenneth. 6TQ	24, Dec.
Prince, E. M. Jr., 5AGJ	15, Jan.
Sjogren, J. A., 1AEA	15, Jan.
Shadrick, G. J., 64AR	15, Jan.
Wick, W. W., 9BMU	15, Jan.
Wilson, D. E., 9CPL	15, Jan.

Page numbers in Roman Numerals refer to Communications Department in issue indicated.

OFFICIAL BROADCASTING STATIONS

I, Feb.	
III, March	
III, April	
V, May	
V, Oct.	
VII, Nov.	
II, Dec.	

PICTURE TRANSMISSION

A Radio Picture Demonstration (R.S.K.)	31, Oct.
More Picture Transmission (Leishman)	58, Feb.
The Voss Picture Transmitter	29, Jan.

POLARIZED TRANSMISSION AND RECEPTION

Experimenters' Section:	40, Jan.; 45, March
Horizontal Reception (Kruse)	9, Feb.
Horizontal Wave Experiments at 2AER (Hollywood)	32, Nov.
Polarized Transmission (Alexanderson)	9, June

RECEIVERS—BROADCAST

A New Reflex Circuit (Hatry)	17, Jan.
A Reflexed Receiver with Resistance Audio Coupling (Hatry)	23, May
Covering All Wavelengths (Clayton)	9, Oct.
Devising a Shielded Receiver Kit (Silver and Clough)	27, Dec.
Multi-Purpose Shielded Units (Henderson)	29, Sept.
The Making of a Single-Control Receiver (Blatterman)	17, April
The Old Reliable (Anderson)	24, March

RECEIVERS—SHORT-WAVE

(See also: Five-Meter Transmission & Reception)	
A Beautiful Portable Set (R.S.K.)	26, Dec.
Amateur Radio to the North Pole Again (Schnell)	33, March
A Portable Transceiver (Gunther)	36, Oct.
A Sensitive Vacuum Tube Relay (Hoffman and Schnell)	20, Nov.
A Shielded Short-Wave Receiver (Marco)	37, Dec.
A Short-Wave R. F. Amplifier (Bouck)	26, Nov.
Covering All Wavelengths (Clayton)	9, Oct.
Easy Tuner Design (Baird)	26, Sept.
Four Tuners in One (Gilchrist)	14, Sept.
Horizontal Reception (Kruse)	9, Feb.
Multiplex Short Wave Reception (Clapp)	21, March
Of, By and For the Beginner (McCormick)	17, June
Peaked Audio Amplifiers (Kruse)	29, April
Short-Wave Plug-in-Coil Receiver Design (Marco)	13, Feb.
Short-Wave Receiving Sets (Hatry)	20, July
Short-Wave Tuner Kits (J.M.C.)	34, Oct.
The Flying Loop (Wright)	36, Nov.
Diagram correction	53, Dec.
The Grebe CR-18 (J.M.C.)	24, June
Tuner Design	42, March

RECEIVERS—GENERAL

A Floating Beat Note (Anderson)	18, Dec.
A Single Control Rig (J.M.C.)	47, Feb.
A Ticker Mounting (F.C.E.)	47, March
Better Multiplex Work (Doran)	63, June
Coil Cement	47, March
Concerning the (grid) Condenser (Raven-Hart)	63, Dec.
Mr. Hatry's Reply (Hatry)	63, Dec.
A Comment from General Electric (Warner)	64, Dec.
For Short-Wave Tuners (J.M.C.)	16, March
Paper Tape on Coils	47, March
Receiving Conditions in England (Blakewell)	46, Feb.
Receiving Without a Grid Leak (A.L.B.)	47, March
Diagram correction	58, April
Regeneration Control (Hobbs)	60, May
The Glue on the Grid Leak	47, March
The Relative Importance of Losses in Radio Receiving Systems (Harper)	21, Dec.
Tuning Tricks (Mueller)	22, Aug.
Unusual Set Construction (R.S.K.)	18, Aug.

RECTIFIERS

A Dry Electrolytic Rectifier (Kruse).....	30, May
Battery Substitutes (Kruse).....	23, Feb.
Breaking Into Amateur Transmission—Part II (Clayton)	17, May
Concerning Electrolytic Rectifiers (Tanner) ..	48, April
Filtering the Synchronous Rectifier (Hoover) ..	35, Feb.
Mercury Arc Rectifiers (Goodall).....	8, Aug.
Operating Receiving Filaments Without Batteries (Kruse).....	25, Aug.
Taming the Synchronous Rectifier (Kruse) ..	9, May
The Epom Rectifier and Filter (Kruse).....	41, Jan.

RELAYS

(See: Break-In and Remote Control)

SHORT-WAVE STATIONS

(Commercial lists, with wavelengths)

49, Jan.
55, March
54, Sept.

STANDARD FREQUENCY TRANSMISSION

AKRL Standard Frequency Station 1XM (Lansingh)	45, June
Correction and addition.....	40, July
O.W.L.S.:	

44, Jan.
8, March
53, May
33, July
65, July
8, Sept.
8, Nov.
18, Dec.

WWV, 1XM and 6XBM Schedules:

44, Jan
56, Jan.
47, Feb.
8, March
16, April
42, April
41, May
65, July
33, Oct.
8, Nov.

WWV May Suspend Transmission (R.S.K.) .. 8, June |

TRANSMITTER—CIRCUITS AND CONSTRUCTION

(See also: Five-Meter Transmission & Reception)	
Another Article on Getting into the Sending Game (Kiefer).....	25, Dec.
A Portable Transceiver (Gunter).....	36, Oct.
A Portable Transmitter (Waynick).....	31, Jan.
Breaking into Amateur Transmission (Clayton) Part I.....	8, April
Part II.....	17, May
Coil Construction	51, April
Converting the ET3619 (Westman).....	20, Sept.
Good Helix Construction	25, Jan.
Hints on the Design of Small Power Trans- formers (Babcock)	29, Oct.
How Our Tube Circuits Work—No. 1—The Hartley Circuit (Kruse).....	9, Dec.
Improved Transmitting Circuits.....	19, Aug.
Of, By and For the Beginner (McCormick) ..	17, June
Reducing Power for Local Work (Turner) ..	33, Oct.
Spark-Coil Portable Transmitters (Wilburn) ..	40, Sept.
Super DX with Indoor Antenna (Simmonds) ..	58, Sept.
Transmitting Coils (Handy).....	29, July
6HM, Mt. Carmel, Calif.....	49, March

TRANSMITTERS—CRYSTAL CONTROL

Adjusting the Crystal-Controlled Transmitter (McMinn)	43, May
--	---------

Amateur Crystals Available (J.M.C.)	48, Sept.
A Multi-Stage Crystal-Controlled Transmitter (Wells and Tillyer)	29, June
An A.C. Crystal-Control Set (Clayton)	23, Jan.
A Shielded Crystal-Controlled Unit (Clayton)	23, Nov.
A 20-40-80-Meter Crystal-Controlled Trans- mitter (Root).....	33, Aug.
Crystal Control at 4XE (Lee).....	21, Jan.
Crystal Cutting (Mason).....	59, Feb.
Examining Quartz for Oscillator Use (Dawson)	23, Sept.
Looking at Quartz (Eshelby).....	52, Nov.
Neutralizing the Crystal Amplifier (J.M.C.) ..	36, March
Practical Crystal-Controlled Transmitters.....	21, Jan.
Quartz Crystal Mountings (Clayton).....	15, July
1BAY, Cambridge, Mass.....	49, Feb.
2AHM, Schenectady, N. Y.....	43, Aug.

TRANSMITTERS—LOW POWER

A Low-Power Transmitter Kit (J.M.C.).....	37, May
Amateur Radio to the North Pole Again (Schnell)	33, March
A Power Amplifier for the Low-Powered Transmitter (Turner).....	29, March
Breaking into Amateur Transmission (Clayton) Part I.....	8, April
Part II.....	17, May
Low Power Dope (Spense)	58, March
Some Low Power Records	43, April
The Flying Loop (Wright).....	36, Nov.

TRANSMITTING—GENERAL

Amateur Wavechangers (Clapp)	35, April
A Tone Meter (Wolf).....	37, Jan.
Break-In and Remote Control (Clayton).....	9, Sept.
Checking the Tone and Wavelength of Transmitters (Clapp).....	19, Dec.
Description of Schenectady Transmitters, ..	33, June
Feeding the Antenna (Kruse).....	8, July
Finding the Inductance of the Filter Choke (Berry)	39, March
Ford Coil Filters (Provins).....	43, March
Inductance Clips.....	27, Jan.
It Isn't Gutter Pipe (Collier)	65, Dec.
Lower-Loss Inductances (J.M.C.)	34, April
Neon Tubes and the Radio Transmitter (Briggs)	30, Oct.
New Phone Band Authorized (K.B.W.)	8, Feb.
Picking a Good Antenna for the Short- Wave Station (Starr).....	27, May
Plug-In Choke Coils	42, March
R. F. Chokes (J.M.C.)	19, July
Secondary Filament Rheostat.....	49, Dec.
Simplifying Operating (use of bug keys).....	21, May
These Rough Notes.....	48, April
Transmitting Grid Leaks.....	49, Dec.
Transmitters in Kit Form (J.M.C.).....	42, Sept.
Transmitting Tube Reactivation (J.M.C.).....	45, May
Tubes in Parallel.....	48, April

TUBES

A Low Capacity Socket.....	25, Sept.
A Non-Microphonic Socket.....	44, April
Detector Action in High-Vacuum Tubes (Smith)	14, Dec.
Finding the Plate Resistance (Muir).....	46, March
Neon Tubes and the Radio Transmitter (Briggs)	30, Oct.
New Tubes (R.S.K.)	33, May
Paralleling Tubes (Bewig).....	67, July
Power Tube Filament Control (Rauch).....	66, July
Power Tube Cooling Hint.....	29, Aug.
Radiotron Model UX-210	38, Sept.
Raytheon Tube.....	41, Jan.
The New DeForest Tube (J.M.C.)	22, Feb.
The UX-874 Regulator Tube (R.S.K.)	32, June
Transmitting Tube Reactivation (J.M.C.).....	45, May
Tubes in Parallel.....	48, April
Tube Reactivation.....	38, March
Using the H Tube.....	45, Sept.

WAVEMETERS AND OSCILLATORS

A Grid-Meter Driver	36, Aug.	Luminous Frequency Standards.....	17, Sept.
An Oscillator without Battery or Transformer (Hanscom)	43, June	Short-Wave Wavemeters.....	31, July
A Reflexed Oscillator (Westman).....	41, Aug.	Using Wavemeters without Indicating Devices (J.M.C.)	19, Sept.
A Shielded Wavemeter for your Station (Schnell)	15, Aug.		
Audio Oscillator (Hines).....	53, Nov.		
Calibrating Your Wavemeter from a Quartz Crystal (Clayton)	39, Feb.		

WHO'S WHO

Dunn, Lawrence J., 2CLA.....	48, March
Thatcher, E. W., 8ZE.....	48, March
Wentworth, Brandon, 601	48, March